

GenX3™ 600V IGBT with Diode

IXGH48N60C3D1

High speed PT IGBT for 40-100kHz Switching

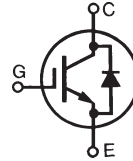

$V_{CES} = 600V$
 $I_{C110} = 48A$
 $V_{CE(sat)} \leq 2.5V$
 $t_{fi(typ)} = 38ns$

Symbol	Test Conditions	Maximum Ratings	
V_{CES}	$T_J = 25^\circ C$ to $150^\circ C$	600	V
V_{CGR}	$T_J = 25^\circ C$ to $150^\circ C$, $R_{GE} = 1M\Omega$	600	V
V_{GES}	Continuous	± 20	V
V_{GEM}	Transient	± 30	V
I_{C25}	$T_C = 25^\circ C$ (Limited by Leads)	75	A
I_{C110}	$T_C = 110^\circ C$	48	A
I_{D110}	$T_C = 110^\circ C$	30	A
I_{CM}	$T_C = 25^\circ C$, 1ms	250	A
I_A	$T_C = 25^\circ C$	30	A
E_{AS}	$T_C = 25^\circ C$	300	mJ
SSOA	$V_{GE} = 15V$, $T_{VJ} = 125^\circ C$, $R_G = 3\Omega$	$I_{CM} = 100$	A
(RBSOA)	Clamped Inductive Load	@ $V_{CE} \leq 600$	V
P_C	$T_C = 25^\circ C$	300	W
T_J		-55 ... +150	$^\circ C$
T_{JM}		150	$^\circ C$
T_{stg}		-55 ... +150	$^\circ C$
T_L	1.6mm (0.062 in.) from Case for 10s	300	$^\circ C$
T_{SOLD}	Plastic Body for 10 Seconds	260	$^\circ C$
F_C	Mounting Torque	1.13/10	Nm/lb.in
Weight		6	g

TO-247

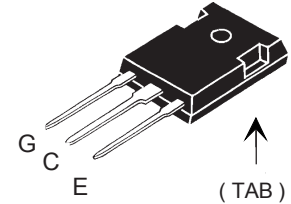

G = Gate C = Collector
 E = Emitter TAB = Collector

Features

- Optimized for Low Switching Losses
- Square RBSOA
- Anti-Parallel Ultra Fast Diode
- Fast Switching
- Avalanche Rated
- International Standard Package

Advantages

- High Power Density
- Low Gate Drive Requirement

Applications

- High Frequency Power Inverters
- UPS
- Motor Drives
- SMPS
- PFC Circuits
- Battery Chargers
- Welding Machines
- Lamp Ballasts

Symbol	Test Conditions ($T_J = 25^\circ C$, Unless Otherwise Specified)	Characteristic Values		
		Min.	Typ.	Max.
$V_{GE(th)}$	$I_C = 250\mu A$, $V_{CE} = V_{GE}$	3.0		5.5 V
I_{CES}	$V_{CE} = V_{CES}$ $V_{GE} = 0V$ $T_J = 125^\circ C$			300 μA 1.75 mA
I_{GES}	$V_{CE} = 0V$, $V_{GE} = \pm 20V$			± 100 nA
$V_{CE(sat)}$	$I_C = 30A$, $V_{GE} = 15V$, Note 1 $T_J = 125^\circ C$	2.3 1.8		2.5 V V

Symbol	Test Conditions	Characteristic Values		
		Min.	Typ.	Max.
g_{fs}	$I_C = 30A, V_{CE} = 10V, \text{Note 1}$	20	30	S
C_{ies}	$V_{CE} = 25V, V_{GE} = 0V, f = 1MHz$		1960	pF
C_{oes}			202	pF
C_{res}			66	pF
Q_g	$I_C = 30A, V_{GE} = 15V, V_{CE} = 0.5 \cdot V_{CES}$		77	nC
Q_{ge}			16	nC
Q_{gc}			32	nC
$t_{d(on)}$	Inductive Load, $T_J = 25^\circ C$ $I_C = 30A, V_{GE} = 15V$ $V_{CE} = 400V, R_G = 3\Omega$		19	ns
t_{ri}			26	ns
E_{on}			0.41	mJ
$t_{d(off)}$			60	100 ns
t_{fi}			38	ns
E_{off}			0.23	0.42 mJ
$t_{d(on)}$	Inductive Load, $T_J = 125^\circ C$ $I_C = 30A, V_{GE} = 15V$ $V_{CE} = 400V, R_G = 3\Omega$		19	ns
t_{ri}			26	ns
E_{on}			0.65	mJ
$t_{d(off)}$			92	ns
t_{fi}			95	ns
E_{off}			0.57	mJ
R_{thJC}			0.42	$^\circ C/W$
R_{thCS}		0.21		$^\circ C/W$

TO-247 AD Outline

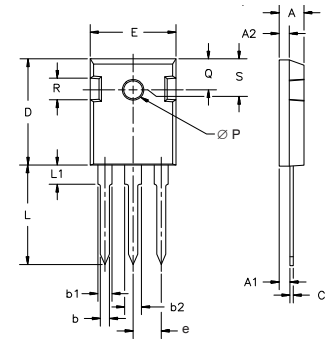

Dim.	Millimeter		Inches	
	Min.	Max.	Min.	Max.
A	4.7	5.3	.185	.209
A ₁	2.2	2.54	.087	.102
A ₂	2.2	2.6	.087	.102
b	1.0	1.4	.040	.055
b ₁	1.65	2.13	.065	.084
b ₂	2.87	3.12	.113	.123
C	.4	.8	.016	.031
D	20.80	21.46	.819	.845
E	15.75	16.26	.610	.640
e	5.20	5.72	0.205	0.225
L	19.81	20.32	.780	.800
L1		4.50		.177
∅P	3.55	3.65	.140	.144
Q	5.89	6.40	0.232	0.252
R	4.32	5.49	.170	.216

Reverse Diode (FRED)

Characteristic Values
($T_J = 25^\circ C$, Unless Otherwise Specified)

Symbol	Test Conditions	Characteristic Values		
		Min.	Typ.	Max.
V_F	$I_F = 30A, V_{GE} = 0V, \text{Note 1}$			2.7 V
		$T_J = 150^\circ C$	1.6	V
I_{RM}	$I_F = 30A, V_{GE} = 0V, -di_F/dt = 100A/\mu s,$	$T_J = 100^\circ C$		4 A
t_{rr}	$V_R = 100V$	$T_J = 100^\circ C$	100	ns
	$I_F = 1A, V_{GE} = 0V, -di_F/dt = 100A/\mu s, V_R = 30V$		25	ns
R_{thJC}				0.9 $^\circ C/W$

Note 1: Pulse Test, $t \leq 300\mu s$, Duty Cycle, $d \leq 2\%$.

IXYS reserves the right to change limits, test conditions, and dimensions.

IXYS MOSFETs and IGBTs are covered by one or more of the following U.S. patents:	4,835,592	4,931,844	5,049,961	5,237,481	6,162,665	6,404,065 B1	6,683,344	6,727,585	7,005,734 B2	7,157,338B2
	4,850,072	5,017,508	5,063,307	5,381,025	6,259,123 B1	6,534,343	6,710,405 B2	6,759,692	7,063,975 B2	
	4,881,106	5,034,796	5,187,117	5,486,715	6,306,728 B1	6,583,505	6,710,463	6,771,478 B2	7,071,537	

**Fig. 1. Output Characteristics
@ 25°C**

**Fig. 2. Extended Output Characteristics
@ 25°C**

**Fig. 3. Output Characteristics
@ 125°C**

**Fig. 4. Dependence of $V_{CE(sat)}$ on
Junction Temperature**

**Fig. 5. Collector-to-Emitter Voltage
vs. Gate-to-Emitter Voltage**

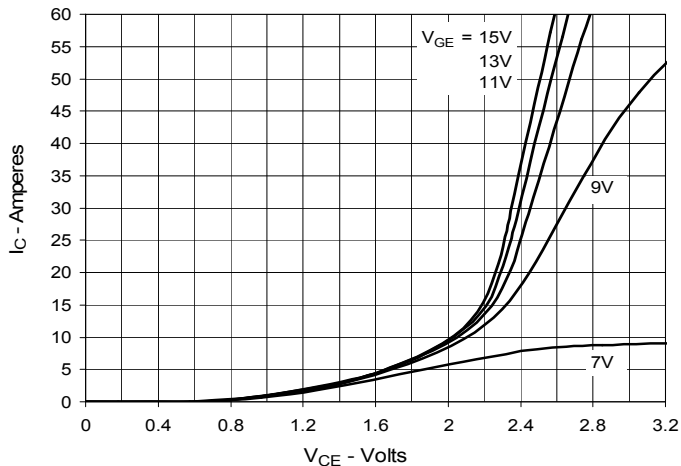
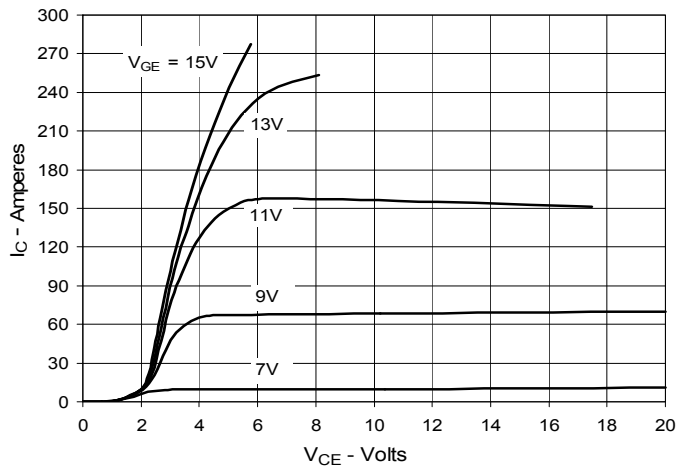
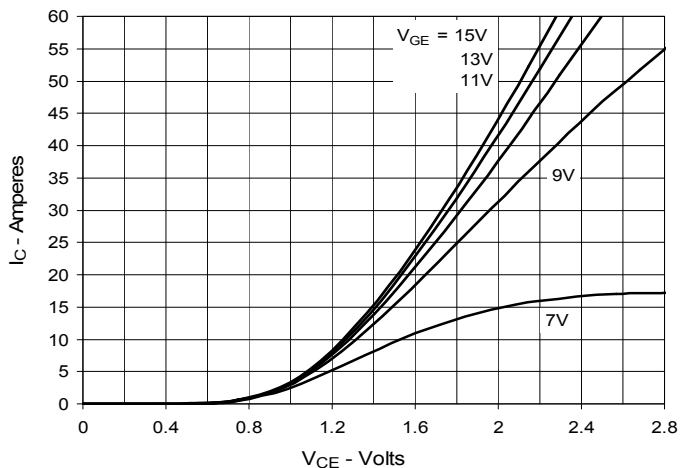
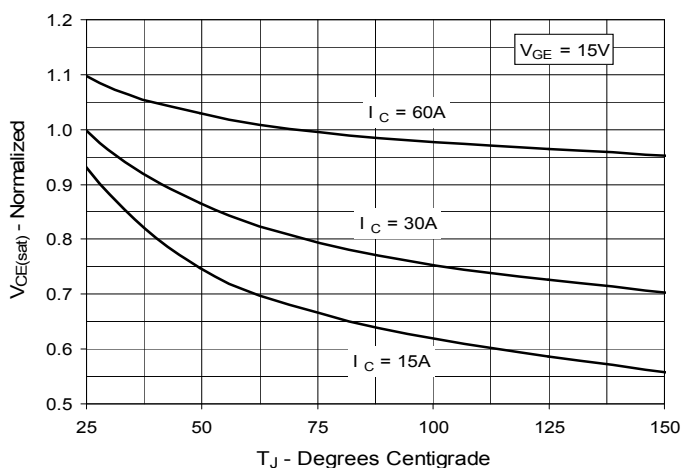
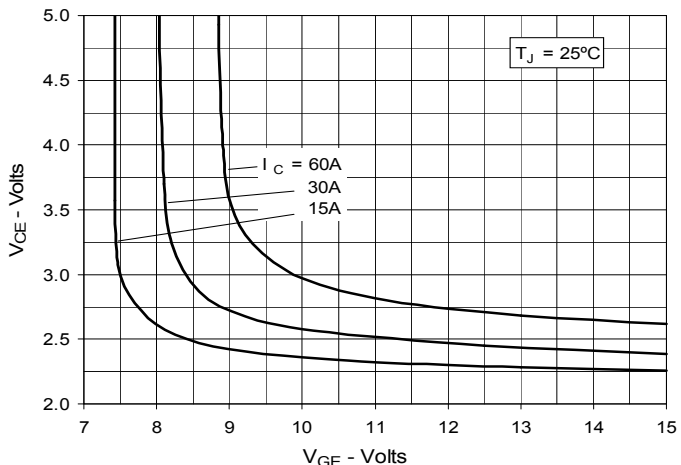
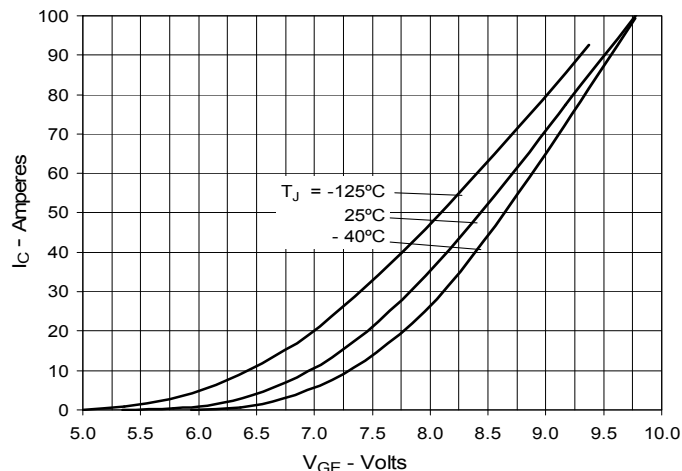
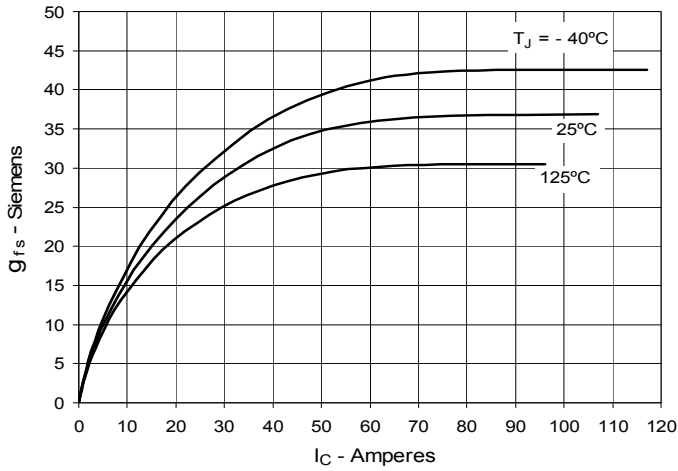
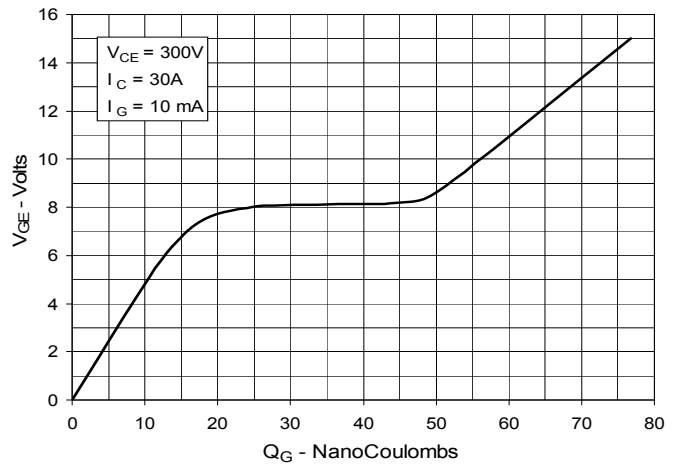
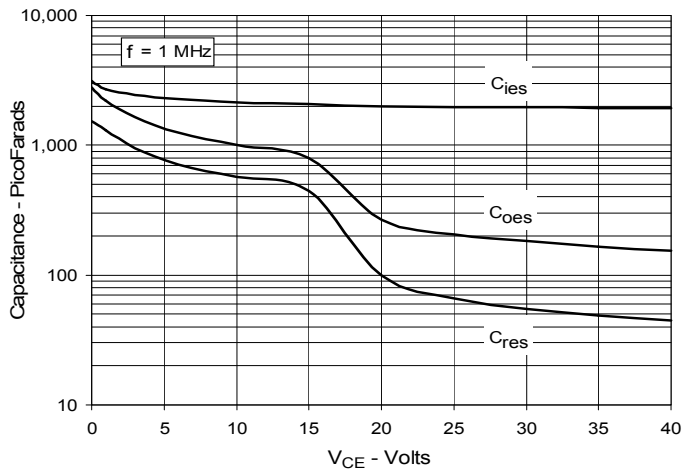
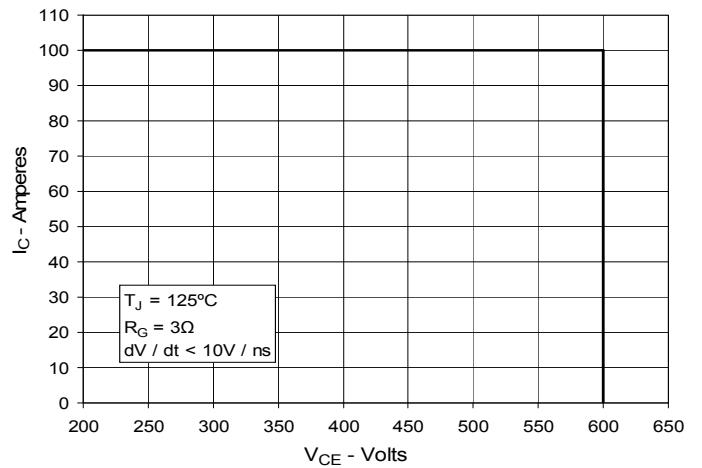
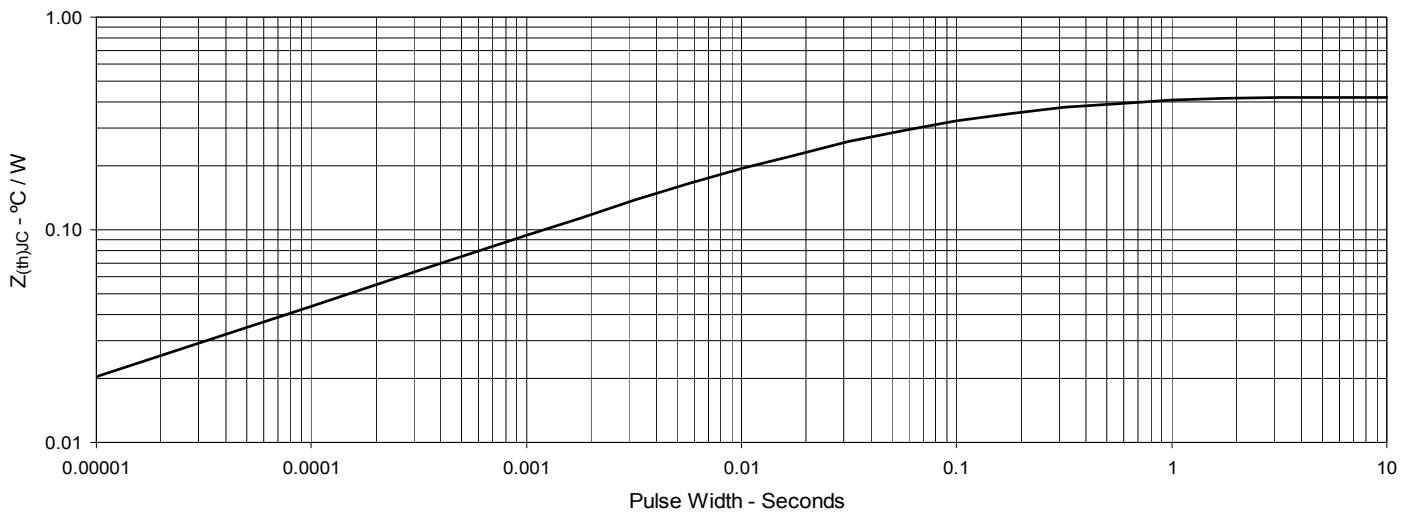
Fig. 6. Input Admittance

Fig. 7. Transconductance

Fig. 8. Gate Charge

Fig. 9. Capacitance

Fig. 10. Reverse-Bias Safe Operating Area

Fig. 11. Maximum Transient Thermal Impedance

IXYS reserves the right to change limits, test conditions, and dimensions.

Fig. 12. Inductive Switching Energy Loss vs. Gate Resistance

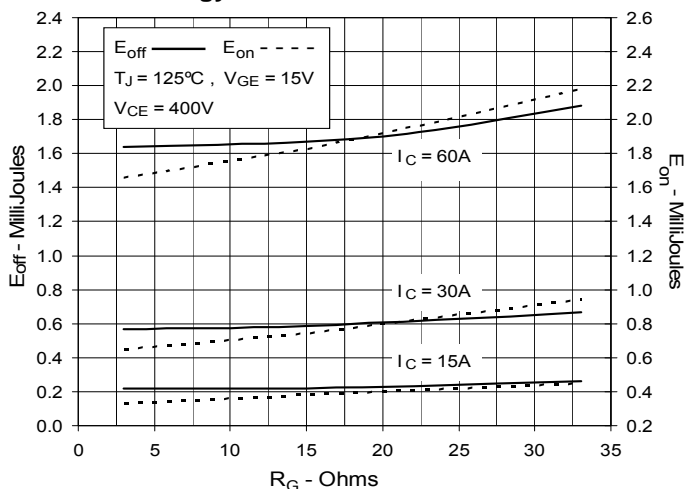

Fig. 13. Inductive Switching Energy Loss vs. Collector Current

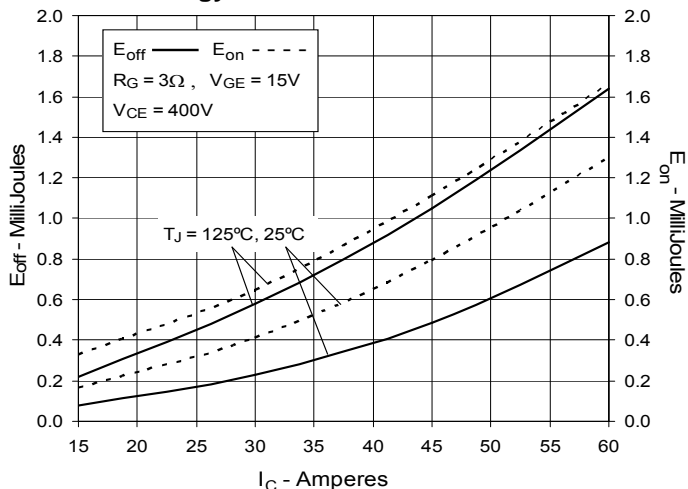

Fig. 14. Inductive Switching Energy Loss vs. Junction Temperature

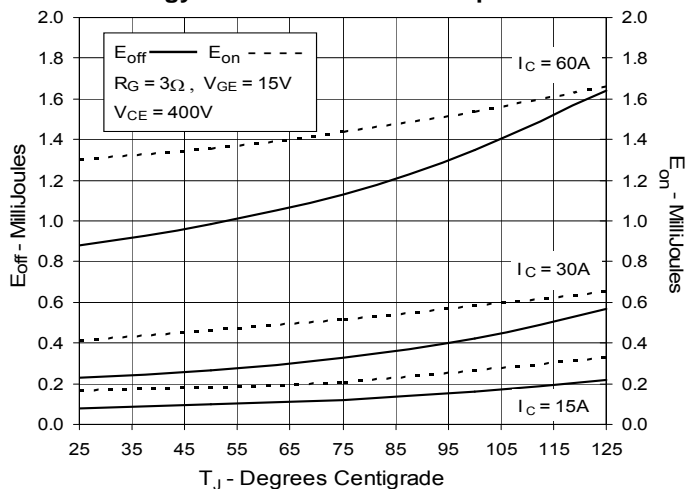

Fig. 15. Inductive Turn-off Switching Times vs. Gate Resistance

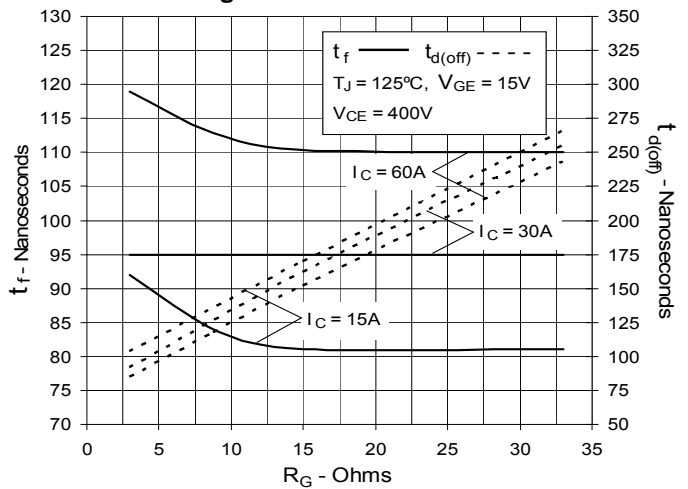

Fig. 16. Inductive Turn-off Switching Times vs. Collector Current

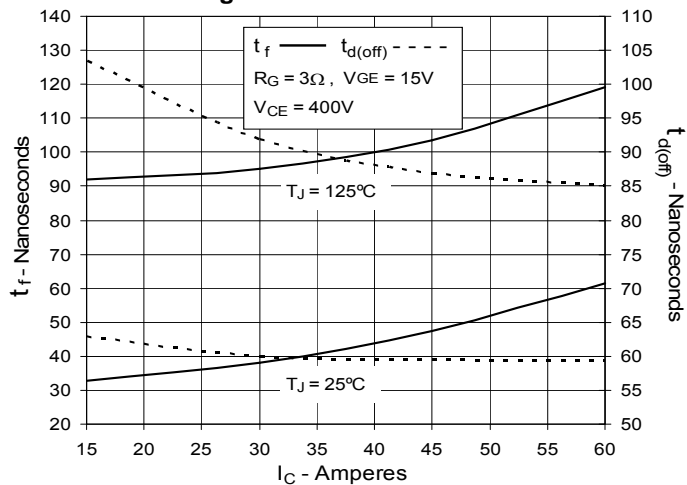

Fig. 17. Inductive Turn-off Switching Times vs. Junction Temperature

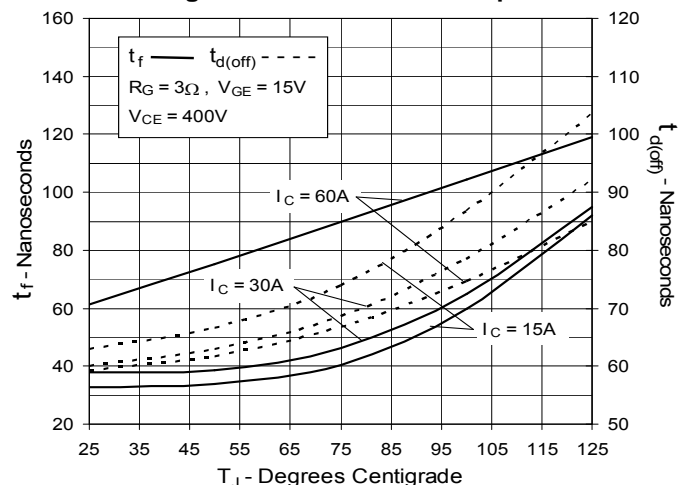

Fig. 18. Inductive Turn-on Switching Times vs. Gate Resistance

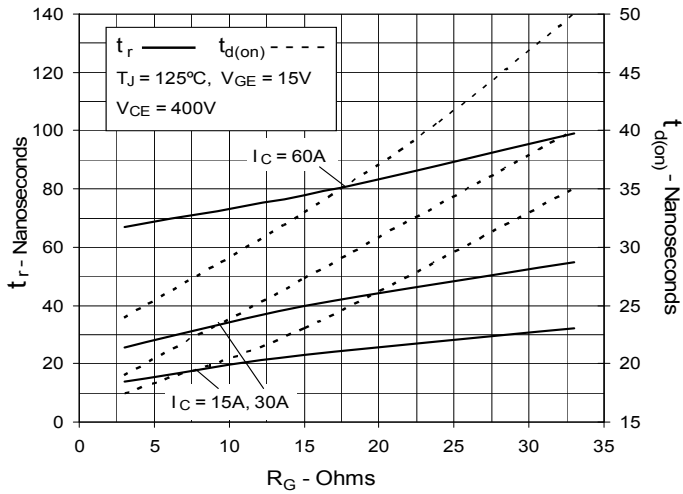

Fig. 19. Inductive Turn-on Switching Times vs. Collector Current

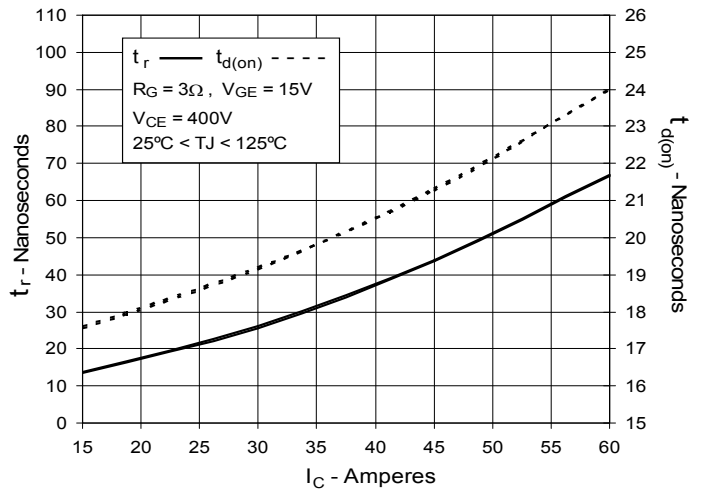
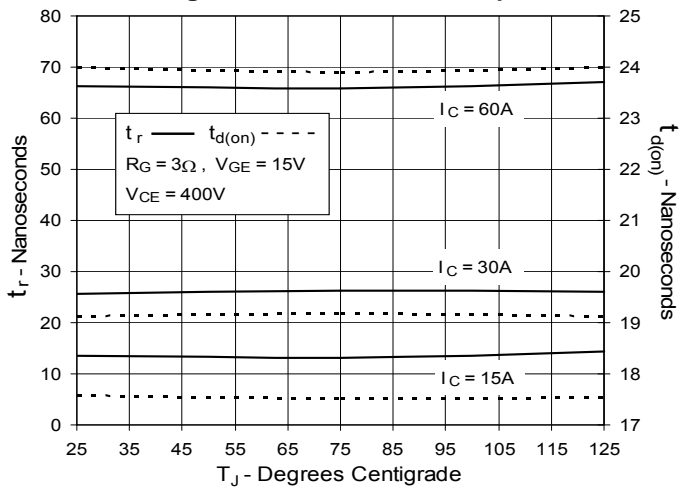

Fig. 20. Inductive Turn-on Switching Times vs. Junction Temperature



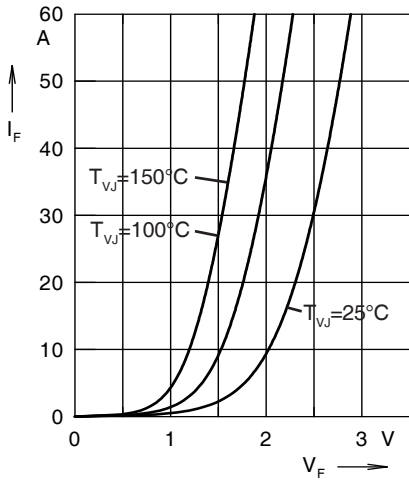

Fig. 21. Forward current I_F versus V_F

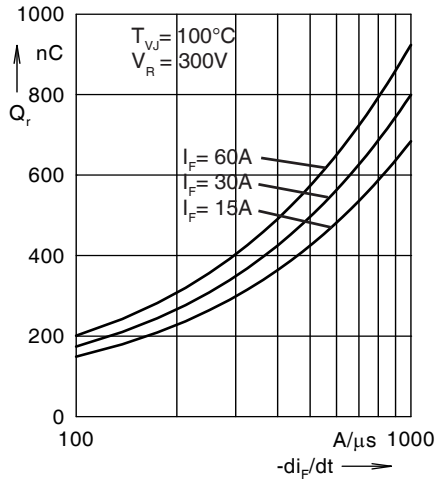

Fig. 22. Reverse recovery charge Q_r versus $-di_F/dt$

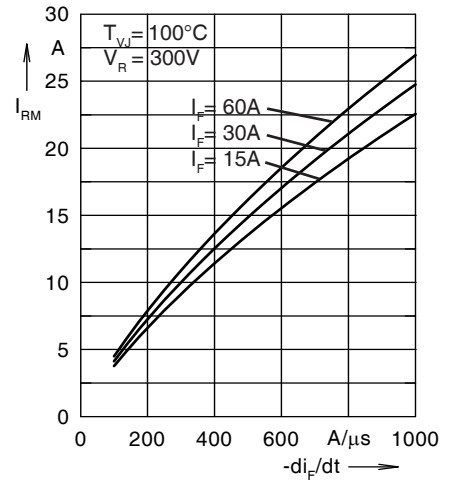

Fig. 23. Peak reverse current I_{RM} versus $-di_F/dt$

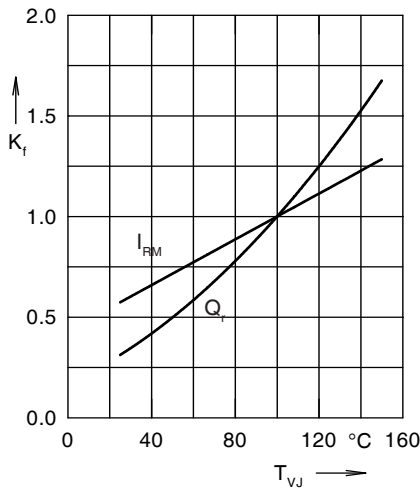

Fig. 24. Dynamic parameters Q_r , I_{RM} versus T_{VJ}

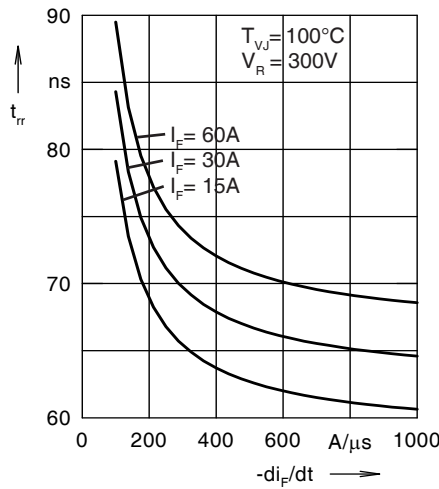

Fig. 25. Recovery time t_{rr} versus $-di_F/dt$

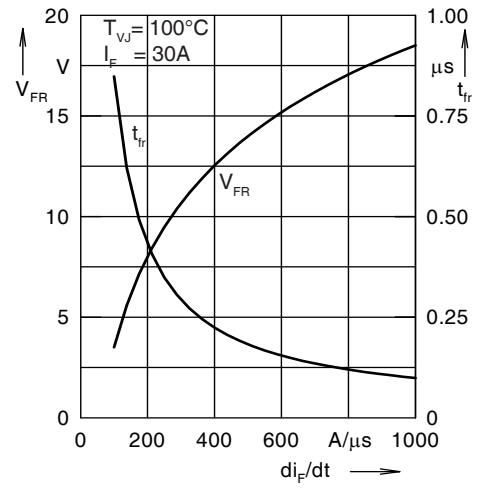

Fig. 26. Peak forward voltage V_{FR} and t_{rr} versus di_F/dt

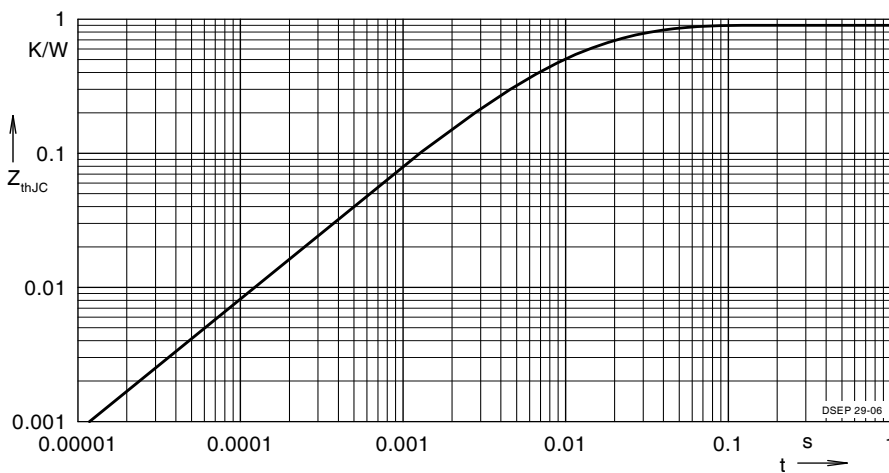

Fig. 27. Transient thermal resistance junction to case

Constants for Z_{thJC} calculation:

i	R_{thi} (K/W)	t_i (s)
1	0.502	0.0052
2	0.193	0.0003
3	0.205	0.0162



Disclaimer Notice - Information furnished is believed to be accurate and reliable. However, users should independently evaluate the suitability of and test each product selected for their own applications. Littelfuse products are not designed for, and may not be used in, all applications. Read complete Disclaimer Notice at www.littelfuse.com/disclaimer-electronics.