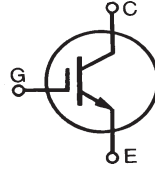


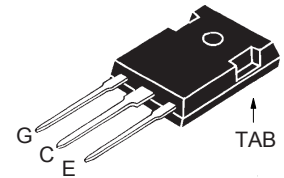
**GenX3™ 1200V IGBT**
**IXGH50N120C3**

High speed PT IGBTs  
for 20 - 50 kHz switching



$$\begin{aligned}
 V_{CES} &= 1200V \\
 I_{C110} &= 50A \\
 V_{CE(sat)} &\leq 4.2V \\
 t_{fi(typ)} &= 64ns
 \end{aligned}$$

Symbol	Test Conditions	Maximum Ratings	
$V_{CES}$	$T_J = 25^\circ\text{C}$ to $150^\circ\text{C}$	1200	V
$V_{CGR}$	$T_J = 25^\circ\text{C}$ to $150^\circ\text{C}$ , $R_{GE} = 1M\Omega$	1200	V
$V_{GES}$	Continuous	$\pm 20$	V
$V_{GEM}$	Transient	$\pm 30$	V
$I_{C25}$	$T_C = 25^\circ\text{C}$ (limited by leads)	75	A
$I_{C110}$	$T_C = 110^\circ\text{C}$	50	A
$I_{CM}$	$T_C = 25^\circ\text{C}$ , 1ms	250	A
$I_A$	$T_C = 25^\circ\text{C}$	40	A
$E_{AS}$	$T_C = 25^\circ\text{C}$	750	mJ
<b>SSOA</b> <b>(RBSOA)</b>	$V_{GE} = 15V$ , $T_J = 125^\circ\text{C}$ , $R_G = 3\Omega$ Clamped inductive load @ $V_{CE} \leq 1200V$	$I_{CM} = 100$	A
$P_C$	$T_C = 25^\circ\text{C}$	460	W
$T_J$		-55 ... +150	$^\circ\text{C}$
$T_{JM}$		150	$^\circ\text{C}$
$T_{stg}$		-55 ... +150	$^\circ\text{C}$
$M_d$	Mounting torque	1.13 / 10	Nm/lb.in.
$T_L$	Maximum lead temperature for soldering	300	$^\circ\text{C}$
$T_{SOLD}$	1.6mm (0.062 in.) from case for 10s	260	$^\circ\text{C}$
<b>Weight</b>		6	g

**TO-247 (IXGH)**


G = Gate      C = Collector  
E = Emitter    TAB = Collector

**Features**

- International standard packages: JEDEC TO-247AD
- IGBT and anti-parallel FRED in one package
- MOS Gate turn-on - drive simplicity

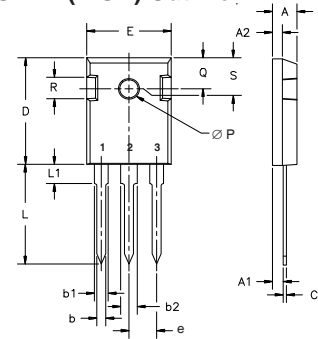
**Applications**

- AC motor speed control
- DC servo and robot drives
- DC choppers
- Uninterruptible power supplies (UPS)
- Switch-mode and resonant-mode power supplies

Symbol	Test Conditions ( $T_J = 25^\circ\text{C}$ , unless otherwise specified)	Characteristic Values		
		Min.	Typ.	Max.
$BV_{CES}$	$I_C = 250\mu\text{A}$ , $V_{GE} = 0V$	1200		V
$V_{GE(th)}$	$I_C = 250\mu\text{A}$ , $V_{CE} = V_{GE}$	3.0		5.0 V
$I_{CES}$	$V_{CE} = V_{CES}$ $V_{GE} = 0V$ $T_J = 125^\circ\text{C}$			100 $\mu\text{A}$ 2 mA
$I_{GES}$	$V_{CE} = 0V$ , $V_{GE} = \pm 20V$			$\pm 100$ nA
$V_{CE(sat)}$	$I_C = 40A$ , $V_{GE} = 15V$ , Note 1 $T_J = 125^\circ\text{C}$		2.6	4.2 V V

Symbol	Test Conditions ( $T_J = 25^\circ\text{C}$ , unless otherwise specified)	Characteristic Values		
		Min.	Typ.	Max.
$g_{fs}$	$I_C = 40\text{A}, V_{CE} = 10\text{V}$ , Note 1	24	40	S
$C_{ies}$	$V_{CE} = 25\text{V}, V_{GE} = 0\text{V}, f = 1\text{MHz}$		4190	pF
$C_{oes}$			330	pF
$C_{res}$			130	pF
$Q_g$	$I_C = 50\text{A}, V_{GE} = 15\text{V}, V_{CE} = 0.5 \cdot V_{CES}$		196	nC
$Q_{ge}$			24	nC
$Q_{gc}$			84	nC
$t_{d(on)}$	<b>Inductive load, <math>T_J = 25^\circ\text{C}</math></b> $I_C = 40\text{A}, V_{GE} = 15\text{V}$ $V_{CE} = 600\text{V}, R_G = 2\Omega$ Note 1		20	ns
$t_{ri}$			34	ns
$E_{on}$			2.2	mJ
$t_{d(off)}$			123	ns
$t_{fi}$			64	ns
$E_{off}$		0.63	1.2	mJ
$t_{d(on)}$	<b>Inductive load, <math>T_J = 125^\circ\text{C}</math></b> $I_C = 40\text{A}, V_{GE} = 15\text{V}$ $V_{CE} = 600\text{V}, R_G = 2\Omega$ Note 1		20	ns
$t_{ri}$			35	ns
$E_{on}$			4.3	mJ
$t_{d(off)}$			170	ns
$t_{fi}$			315	ns
$E_{off}$		2.1	mJ	
$R_{thJC}$				$0.27^\circ\text{C/W}$
$R_{thCK}$		0.21		$^\circ\text{C/W}$

TO-247 (IXGH) Outline



Terminals: 1 - Gate 2 - Drain  
3 - Source Tab - Drain

Dim.	Millimeter		Inches	
	Min.	Max.	Min.	Max.
A	4.7	5.3	.185	.209
A <sub>1</sub>	2.2	2.54	.087	.102
A <sub>2</sub>	2.2	2.6	.059	.098
b	1.0	1.4	.040	.055
b <sub>1</sub>	1.65	2.13	.065	.084
b <sub>2</sub>	2.87	3.12	.113	.123
C	.4	.8	.016	.031
D	20.80	21.46	.819	.845
E	15.75	16.26	.610	.640
e	5.20	5.72	0.205	0.225
L	19.81	20.32	.780	.800
L1		4.50		.177
ØP	3.55	3.65	.140	.144
Q	5.89	6.40	0.232	0.252
R	4.32	5.49	.170	.216
S	6.15	BSC	242	BSC

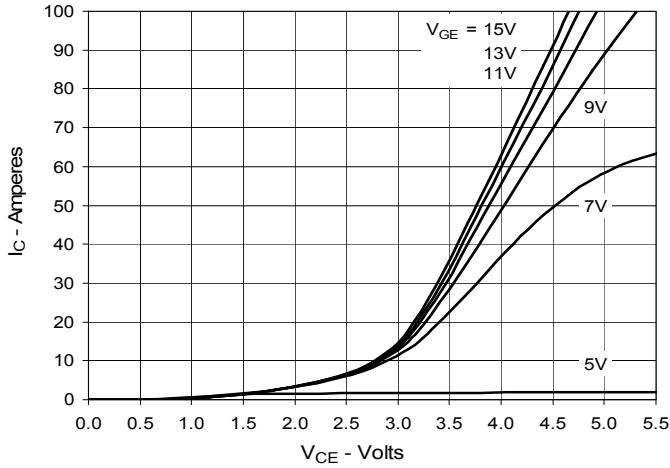
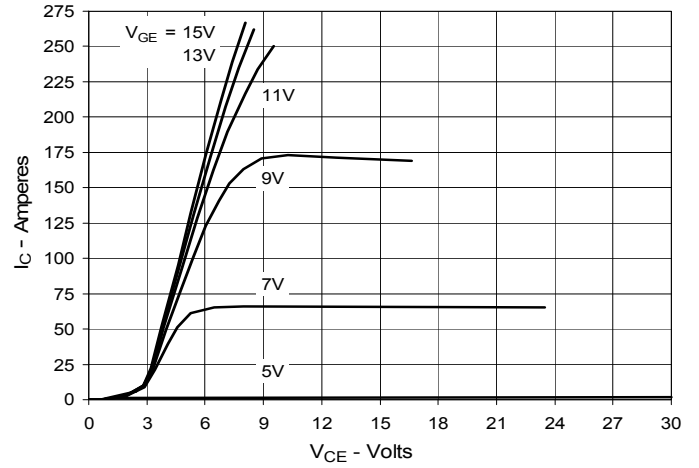
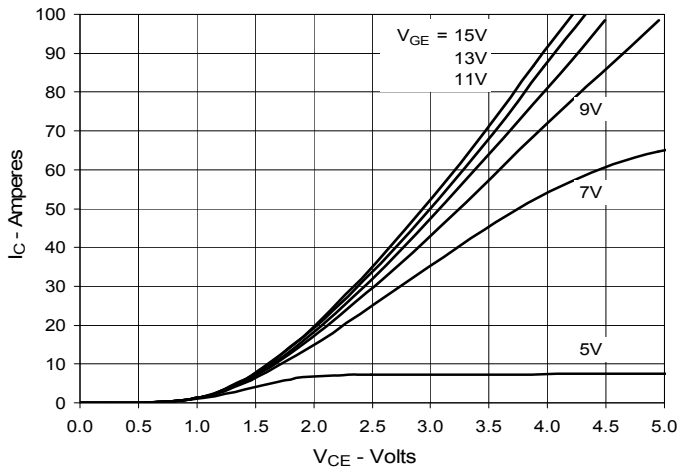
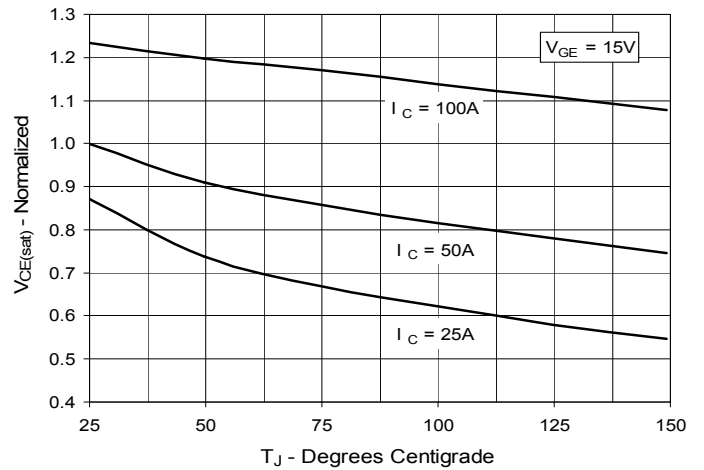
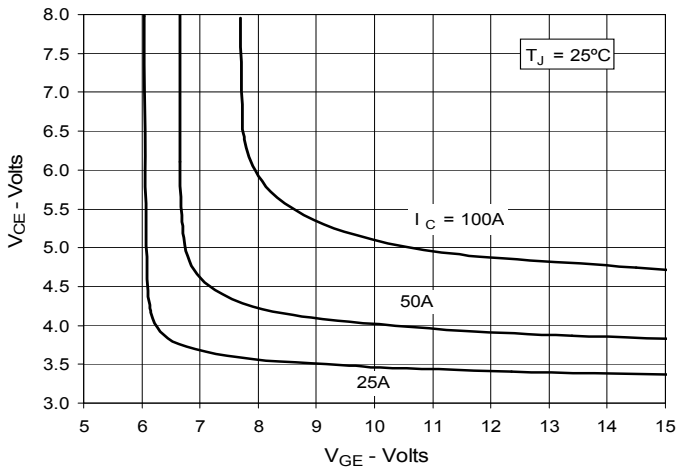
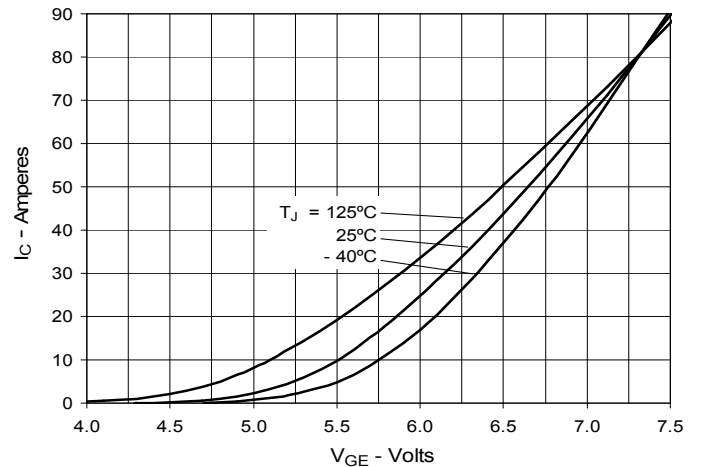
Notes: 1. Pulse test,  $t \leq 300\mu\text{s}$ ; duty cycle,  $d \leq 2\%$ .

### PRELIMINARY TECHNICAL INFORMATION

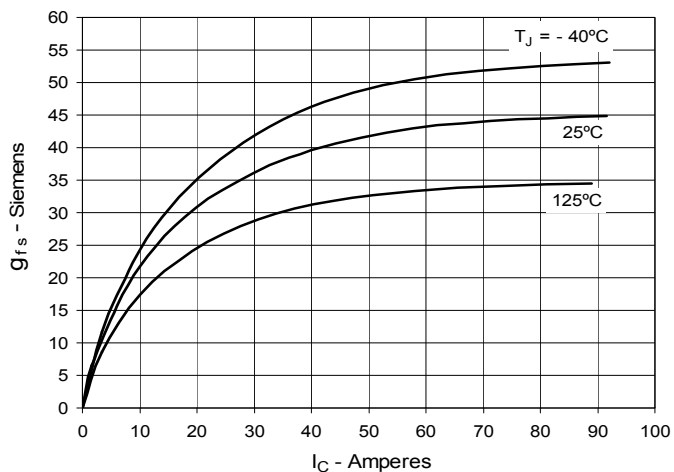
The product presented herein is under development. The Technical Specifications offered are derived from data gathered during objective characterizations of preliminary engineering lots; but also may yet contain some information supplied during a pre-production design evaluation. IXYS reserves the right to change limits, test conditions, and dimensions without notice.

IXYS reserves the right to change limits, test conditions, and dimensions.

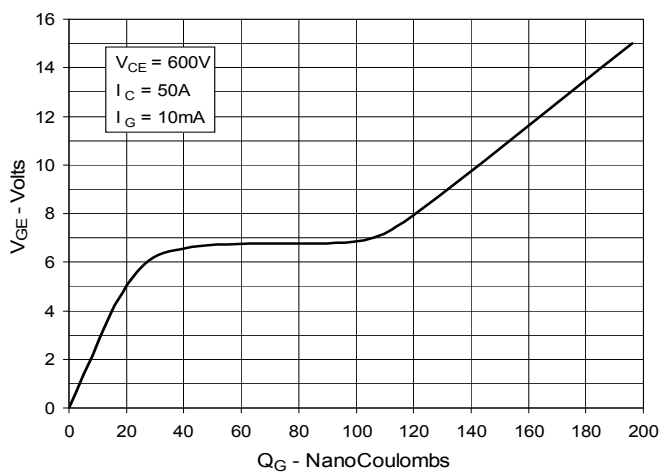
IXYS MOSFETs and IGBTs are covered 4,835,592 4,931,844 5,049,961 5,237,481 6,162,665 6,404,065 B1 6,683,344 6,727,585 7,005,734 B2 7,157,338B2  
by one or more of the following U.S. patents: 4,850,072 5,017,508 5,063,307 5,381,025 6,259,123 B1 6,534,343 6,710,405 B2 6,759,692 7,063,975 B2  
4,881,106 5,034,796 5,187,117 5,486,715 6,306,728 B1 6,583,505 6,710,463 6,771,478 B2 7,071,537

**Fig. 1. Output Characteristics  
@ 25°C**

**Fig. 2. Extended Output Characteristics  
@ 25°C**

**Fig. 3. Output Characteristics  
@ 125°C**

**Fig. 4. Dependence of  $V_{CE(sat)}$  on  
Junction Temperature**

**Fig. 5. Collector-to-Emitter Voltage  
vs. Gate-to-Emitter Voltage**

**Fig. 6. Input Admittance**


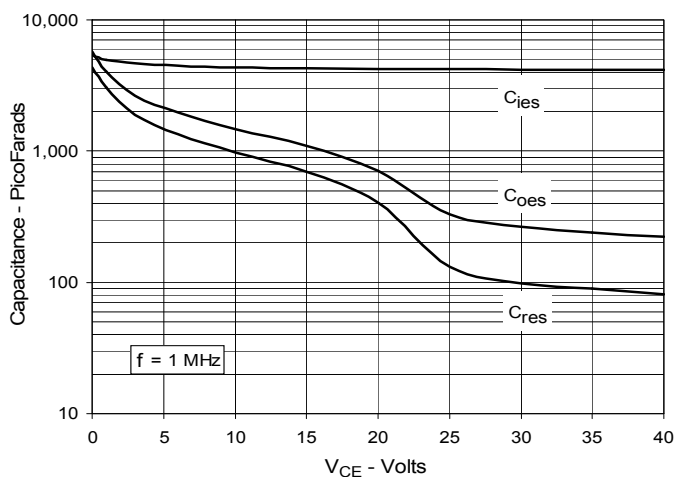
**Fig. 7. Transconductance**



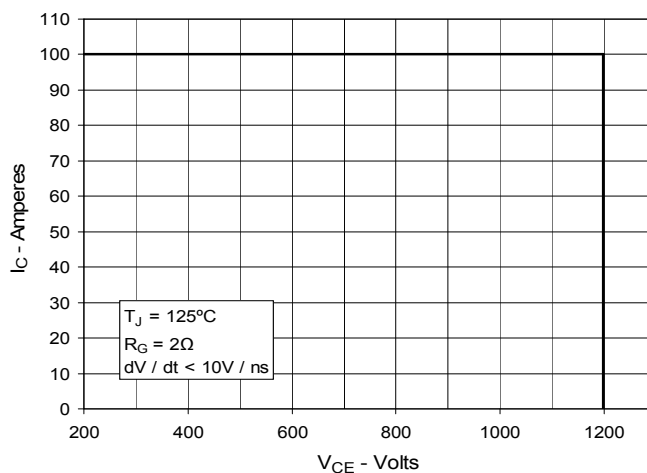
**Fig. 8. Gate Charge**



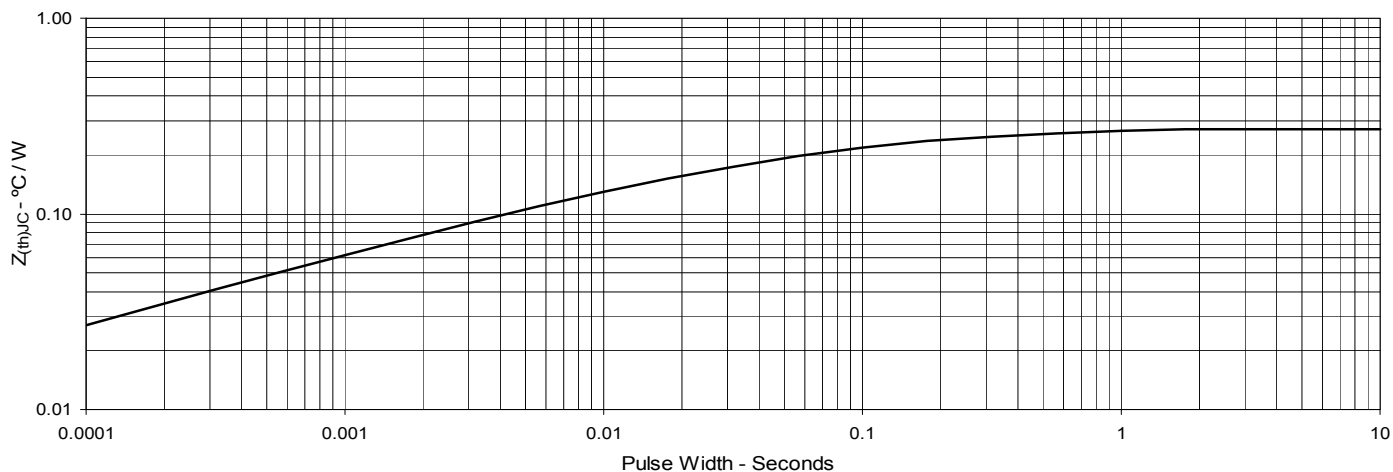
**Fig. 9. Capacitance**

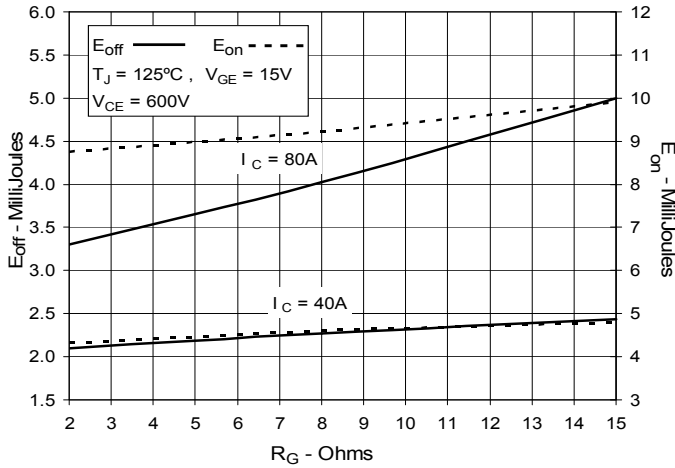
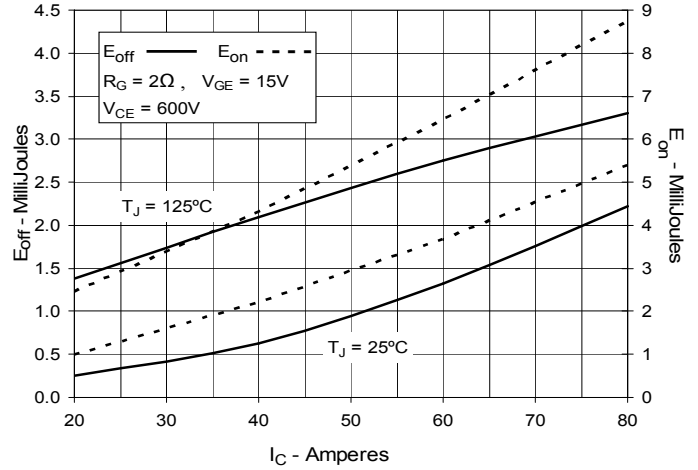
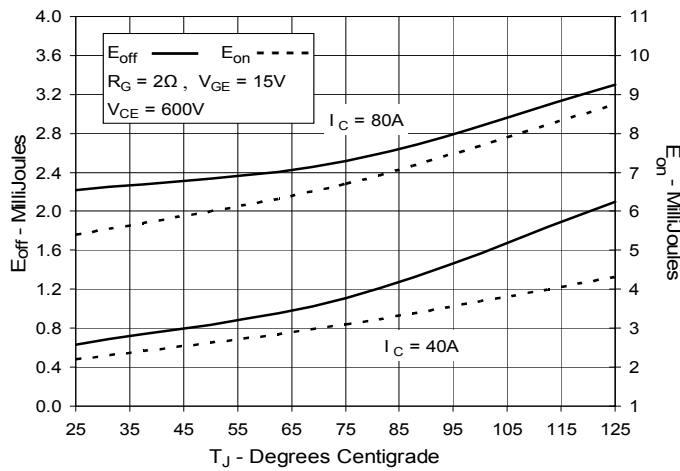
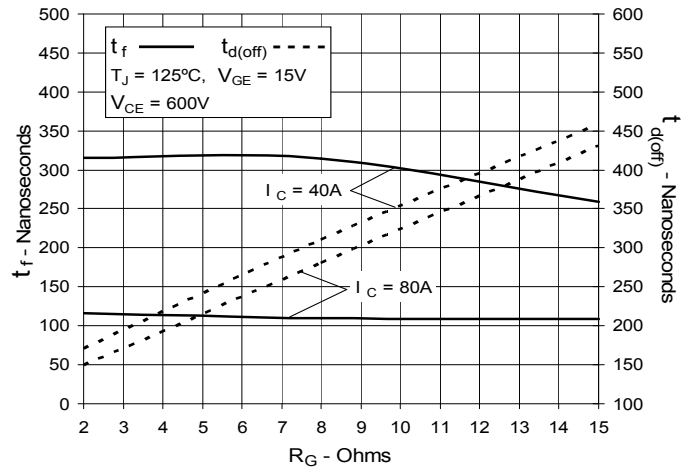
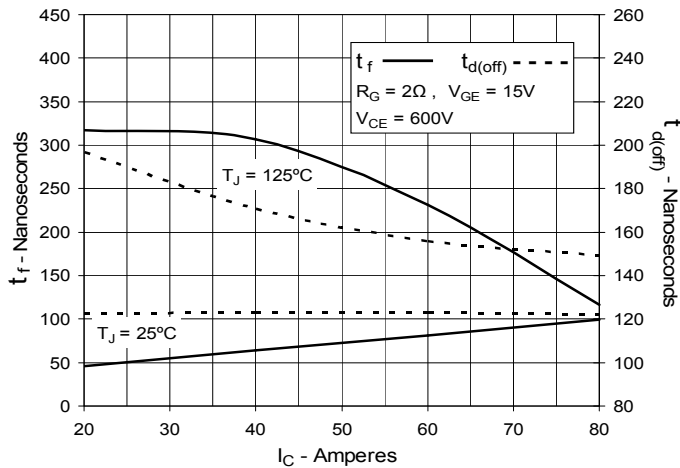
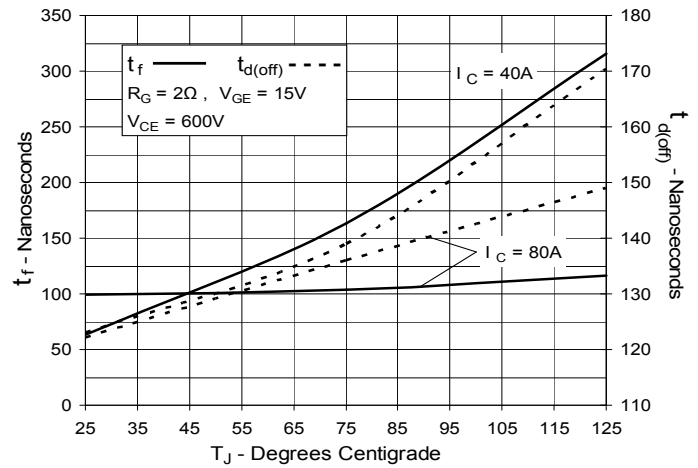


**Fig. 10. Reverse-Bias Safe Operating Area**

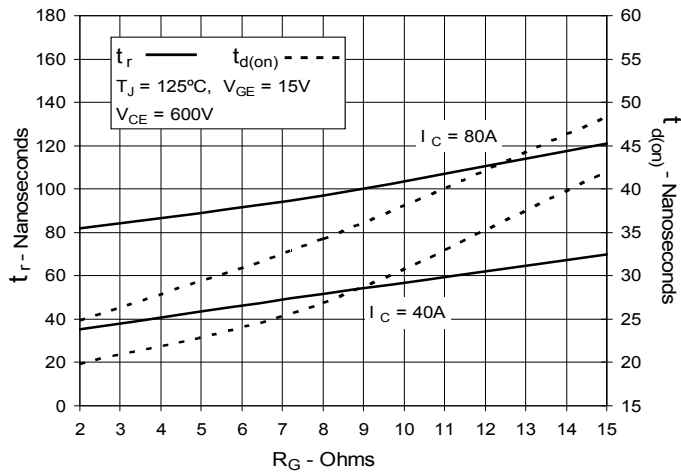


**Fig. 11. Maximum Transient Thermal Impedance**

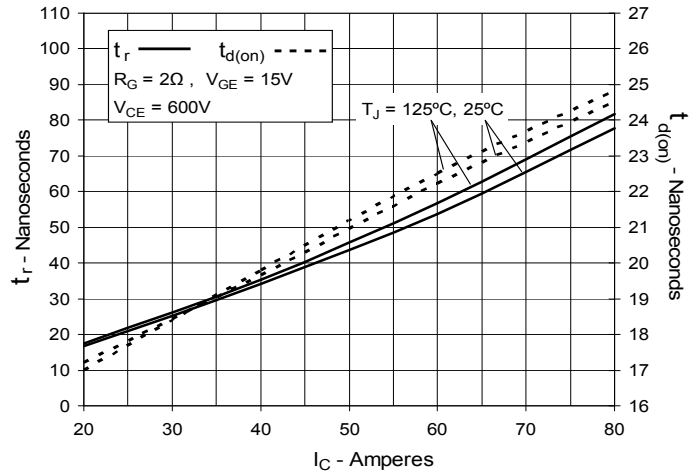


**Fig. 12. Inductive Switching  
Energy Loss vs. Gate Resistance**

**Fig. 13. Inductive Switching  
Energy Loss vs. Collector Current**

**Fig. 14. Inductive Switching  
Energy Loss vs. Junction Temperature**

**Fig. 15. Inductive Turn-off  
Switching Times vs. Gate Resistance**

**Fig. 16. Inductive Turn-off  
Switching Times vs. Collector Current**

**Fig. 17. Inductive Turn-off  
Switching Times vs. Junction Temperature**


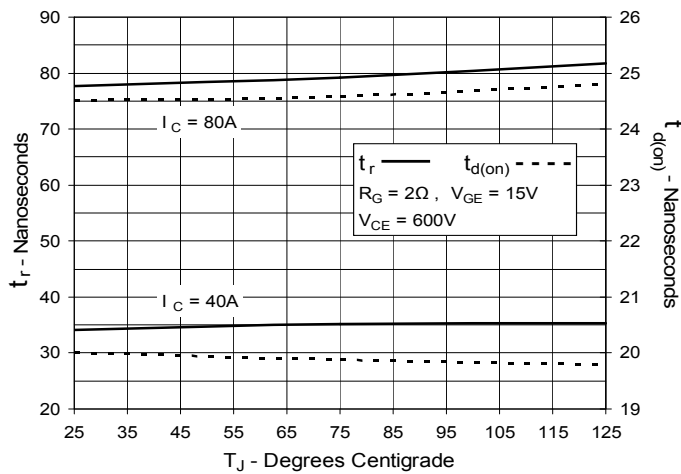
**Fig. 18. Inductive Turn-on Switching Times vs. Gate Resistance**



**Fig. 19. Inductive Turn-on Switching Times vs. Collector Current**



**Fig. 20. Inductive Turn-on Switching Times vs. Junction Temperature**





---

Disclaimer Notice - Information furnished is believed to be accurate and reliable. However, users should independently evaluate the suitability of and test each product selected for their own applications. Littelfuse products are not designed for, and may not be used in, all applications. Read complete Disclaimer Notice at [www.littelfuse.com/disclaimer-electronics](http://www.littelfuse.com/disclaimer-electronics).