

HiPerFAST™ IGBT

C2-Class High Speed IGBTs

IXGH 60N60C2
IXGT 60N60C2

$V_{CES} = 600 \text{ V}$
 $I_{C25} = 75 \text{ A}$
 $V_{CE(sat)} = 2.5 \text{ V}$
 $t_{fi typ} = 35 \text{ ns}$

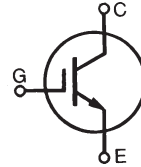

| Symbol | Test Conditions | Maximum Ratings | |
|---|---|------------------|------------------|
| V_{CES} | $T_J = 25^\circ\text{C}$ to 150°C | 600 | V |
| V_{CGR} | $T_J = 25^\circ\text{C}$ to 150°C ; $R_{GE} = 1 \text{ M}\Omega$ | 600 | V |
| V_{GES} | Continuous | ± 20 | V |
| V_{GEM} | Transient | ± 30 | V |
| I_{C25} | $T_C = 25^\circ\text{C}$ (limited by leads) | 75 | A |
| I_{C110} | $T_C = 110^\circ\text{C}$ | 60 | A |
| I_{CM} | $T_C = 25^\circ\text{C}$, 1 ms | 300 | A |
| SSOA (RBSOA) | $V_{GE} = 15 \text{ V}$, $T_{VJ} = 125^\circ\text{C}$, $R_G = 10 \Omega$ Clamped inductive load @ $\leq 600 \text{ V}$ | $I_{CM} = 100$ | A |
| P_C | $T_C = 25^\circ\text{C}$ | 480 | W |
| T_J | | -55 ... +150 | $^\circ\text{C}$ |
| T_{JM} | | 150 | $^\circ\text{C}$ |
| T_{stg} | | -55 ... +150 | $^\circ\text{C}$ |
| Maximum lead temperature for soldering 1.6 mm (0.062 in.) from case for 10 s | | 300 | $^\circ\text{C}$ |
| M_d | Mounting torque (TO-247) | 1.13/10Nm/lb.in. | |
| Weight | | TO-247 AD | 6 g |
| | | TO-268 | 4 g |

TO-247 AD
(IXGH)

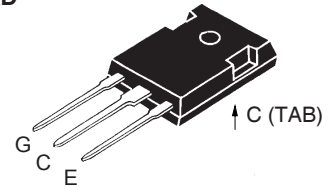

TO-268
(IXGT)

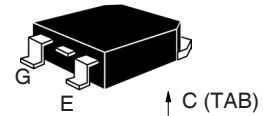

G = Gate,
E = Emitter,

C = Collector,
TAB = Collector

Features

- Very high frequency IGBT
- Square RBSOA
- High current handling capability
- MOS Gate turn-on
- drive simplicity

Applications

- PFC circuits
- Uninterruptible power supplies (UPS)
- Switched-mode and resonant-mode power supplies
- AC motor speed control
- DC servo and robot drives
- DC choppers

Advantages

- High power density
- Very fast switching speeds for high frequency applications

| Symbol | Test Conditions | Characteristic Values ($T_J = 25^\circ\text{C}$, unless otherwise specified) | | |
|---------------|--|---|---|--------------------------|
| | | min. | typ. | max. |
| $V_{GE(th)}$ | $I_C = 250 \mu\text{A}$, $V_{CE} = V_{GE}$ | 3.0 | | 5.0 V |
| I_{CES} | $V_{CE} = V_{CES}$ $V_{GE} = 0 \text{ V}$ | | $T_J = 25^\circ\text{C}$ $T_J = 150^\circ\text{C}$ | 50 μA 1 mA |
| I_{GES} | $V_{CE} = 0 \text{ V}$, $V_{GE} = \pm 20 \text{ V}$ | | | $\pm 100 \text{ nA}$ |
| $V_{CE(sat)}$ | $I_C = 50 \text{ A}$, $V_{GE} = 15 \text{ V}$ | $T_J = 25^\circ\text{C}$ $T_J = 125^\circ\text{C}$ | 2.1 1.8 | 2.5 V V |

| Symbol | Test Conditions | Characteristic Values ($T_J = 25^\circ\text{C}$, unless otherwise specified) | | | |
|--|--|---|------|------------|----|
| | | min. | typ. | max. | |
| g_{fs} | $I_C = 50\text{ A}; V_{CE} = 10\text{ V}$, Pulse test, $t \leq 300\ \mu\text{s}$, duty cycle $\leq 2\%$ | 40 | 58 | S | |
| C_{ies} C_{oes} C_{res} | $V_{CE} = 25\text{ V}, V_{GE} = 0\text{ V}, f = 1\text{ MHz}$ | | 3900 | pF | |
| | | | 280 | pF | |
| | | | 97 | pF | |
| Q_g Q_{ge} Q_{gc} | $I_C = 50\text{ A}, V_{GE} = 15\text{ V}, V_{CE} = 0.5 V_{CES}$ | | 146 | nC | |
| | | | 28 | nC | |
| | | | 50 | nC | |
| $t_{d(on)}$ t_{ri} $t_{d(off)}$ t_{fi} E_{off} | Inductive load, $T_J = 25^\circ\text{C}$ $I_C = 50\text{ A}, V_{GE} = 15\text{ V}$ $V_{CE} = 400\text{ V}, R_G = R_{off} = 2\ \Omega$ | | 18 | ns | |
| | | | 25 | ns | |
| | | | 95 | 150 | ns |
| | | | 35 | ns | |
| | | | 0.48 | 0.8 | mJ |
| $t_{d(on)}$ t_{ri} E_{on} $t_{d(off)}$ t_{fi} E_{off} | Inductive load, $T_J = 125^\circ\text{C}$ $I_C = 50\text{ A}, V_{GE} = 15\text{ V}$ $V_{CE} = 400\text{ V}, R_G = R_{off} = 2\ \Omega$ | | 18 | ns | |
| | | | 25 | ns | |
| | | | 0.45 | mJ | |
| | | | 130 | ns | |
| | | | 80 | ns | |
| | | | 1.2 | mJ | |
| R_{thJC} R_{thCK} | (TO-247) | | | 0.26 KW | |
| | | 0.25 | | KW | |

Min. Recommended Footprint (Dimensions in inches and mm)

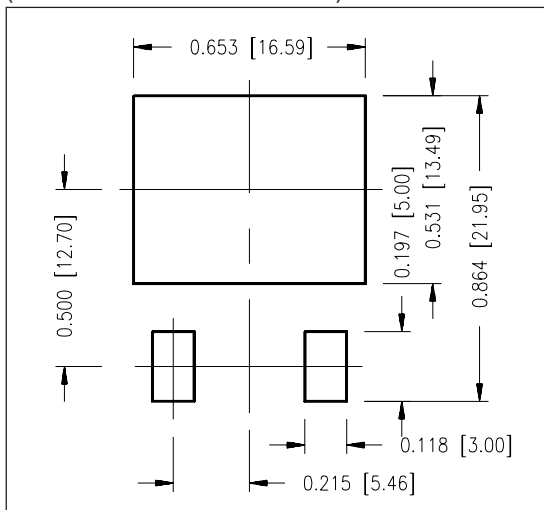

TO-247 AD Outline

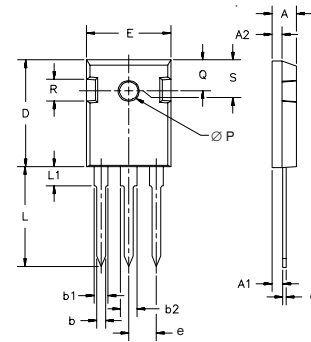

| Dim. | Millimeter | | Inches | |
|----------------|------------|-------|--------|-------|
| | Min. | Max. | Min. | Max. |
| A | 4.7 | 5.3 | .185 | .209 |
| A ₁ | 2.2 | 2.54 | .087 | .102 |
| A ₂ | 2.2 | 2.6 | .059 | .098 |
| b | 1.0 | 1.4 | .040 | .055 |
| b ₁ | 1.65 | 2.13 | .065 | .084 |
| b ₂ | 2.87 | 3.12 | .113 | .123 |
| C | .4 | .8 | .016 | .031 |
| D | 20.80 | 21.46 | .819 | .845 |
| E | 15.75 | 16.26 | .610 | .640 |
| e | 5.20 | 5.72 | 0.205 | 0.225 |
| L | 19.81 | 20.32 | .780 | .800 |
| L ₁ | | 4.50 | | .177 |
| ∅P | 3.55 | 3.65 | .140 | .144 |
| Q | 5.89 | 6.40 | 0.232 | 0.252 |
| R | 4.32 | 5.49 | .170 | .216 |
| S | 6.15 | BSC | .242 | BSC |

TO-268 Outline

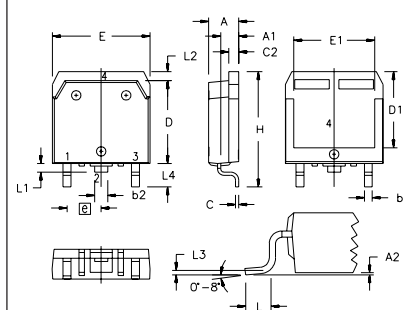

| SYM | INCHES | | MILLIMETERS | |
|----------------|----------|------|-------------|-------|
| | MIN | MAX | MIN | MAX |
| A | .193 | .201 | 4.90 | 5.10 |
| A ₁ | .106 | .114 | 2.70 | 2.90 |
| A ₂ | .001 | .010 | 0.02 | 0.25 |
| b | .045 | .057 | 1.15 | 1.45 |
| b ₂ | .075 | .083 | 1.90 | 2.10 |
| C | .016 | .026 | 0.40 | 0.65 |
| C ₂ | .057 | .063 | 1.45 | 1.60 |
| D | .543 | .551 | 13.80 | 14.00 |
| D ₁ | .488 | .500 | 12.40 | 12.70 |
| E | .624 | .632 | 15.85 | 16.05 |
| E ₁ | .524 | .535 | 13.30 | 13.60 |
| e | .215 BSC | | 5.45 BSC | |
| H | .736 | .752 | 18.70 | 19.10 |
| L | .094 | .106 | 2.40 | 2.70 |
| L ₁ | .047 | .055 | 1.20 | 1.40 |
| L ₂ | .039 | .045 | 1.00 | 1.15 |
| L ₃ | .010 BSC | | 0.25 BSC | |
| L ₄ | .150 | .161 | 3.80 | 4.10 |

IXYS reserves the right to change limits, test conditions, and dimensions.

Fig. 1. Output Characteristics
@ 25 Deg. C

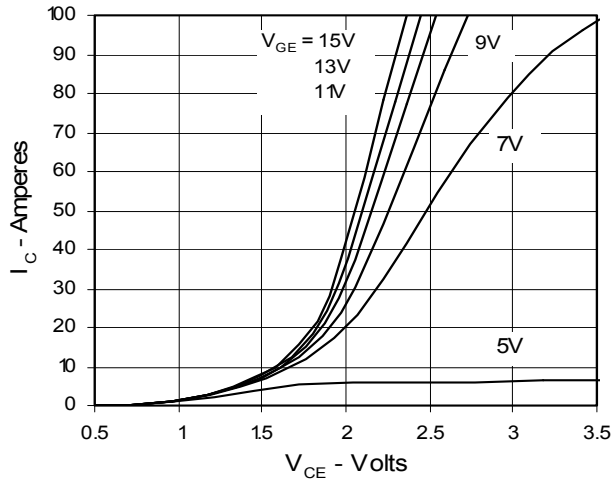

Fig. 2. Extended Output Characteristics
@ 25 deg. C

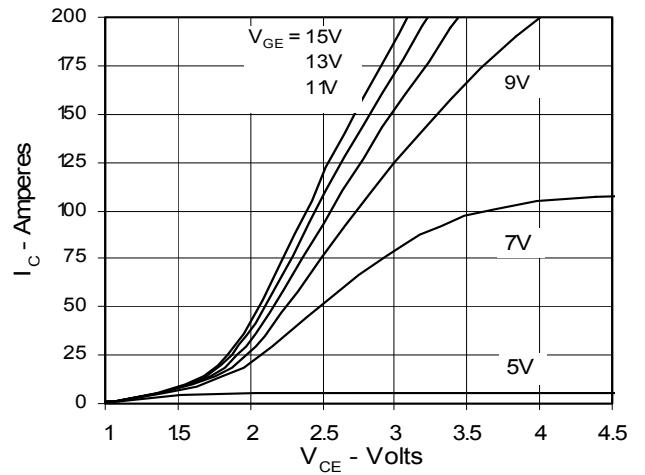

Fig. 3. Output Characteristics
@ 125 Deg. C

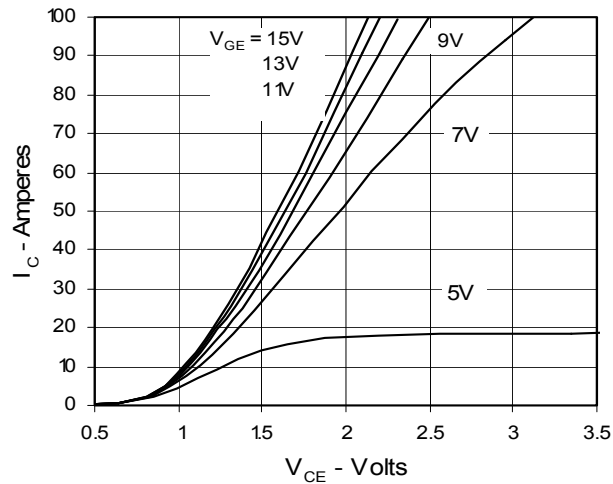

Fig. 4. Temperature Dependence of $V_{CE(sat)}$

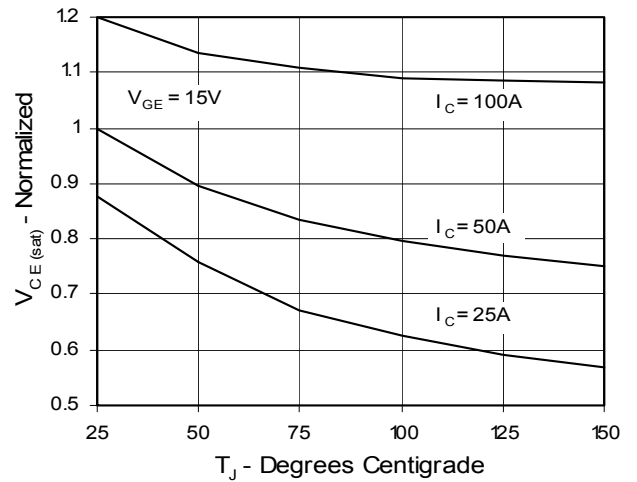

Fig. 5. Collector-to-Emitter Voltage vs. Gate-to-Emitter voltage

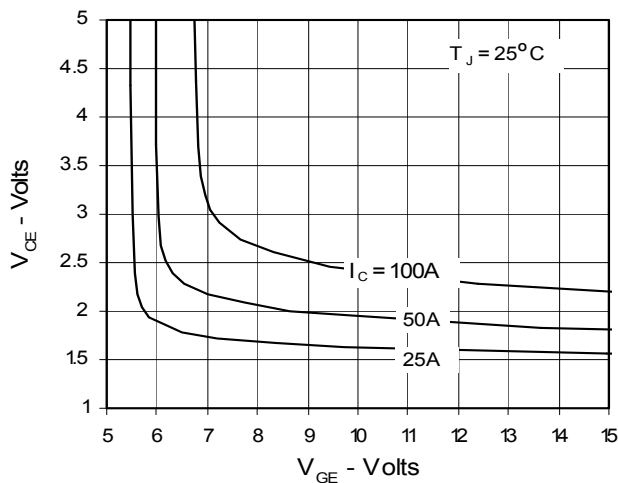

Fig. 6. Input Admittance

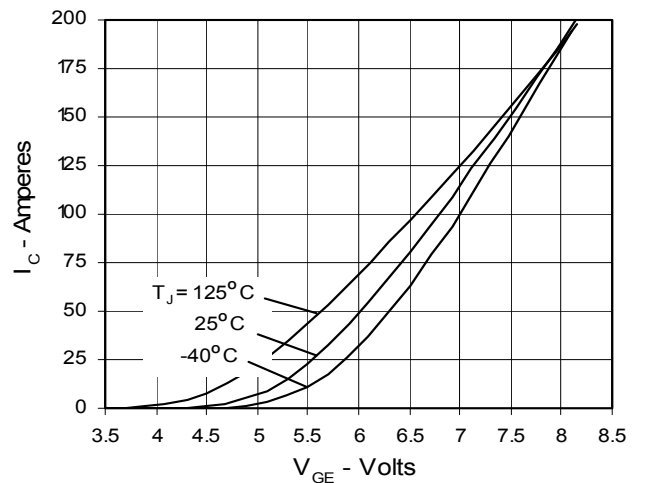

Fig. 7. Transconductance

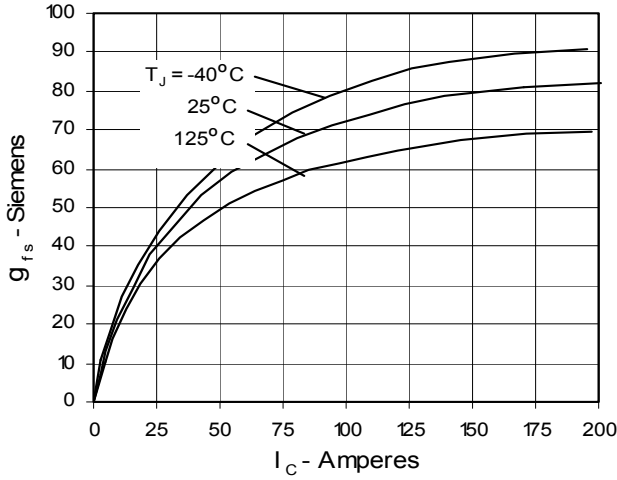

Fig. 8. Dependence of E_{off} on R_G

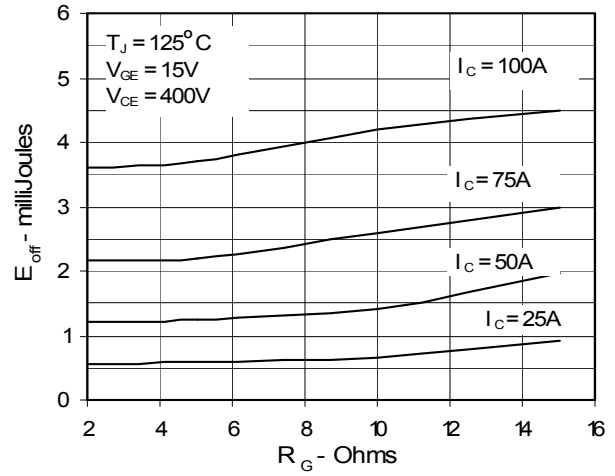

Fig. 9. Dependence of E_{off} on I_C

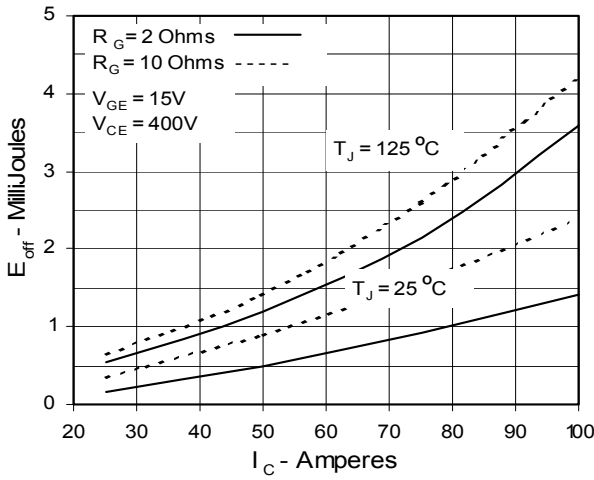

Fig. 10. Dependence of E_{off} on Temperature

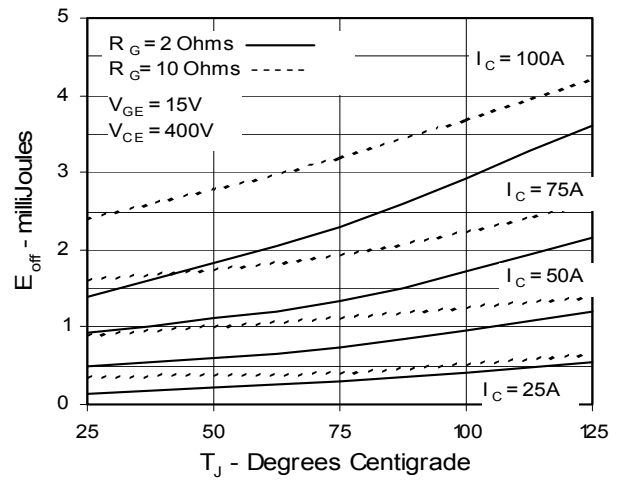

Fig. 11. Gate Charge

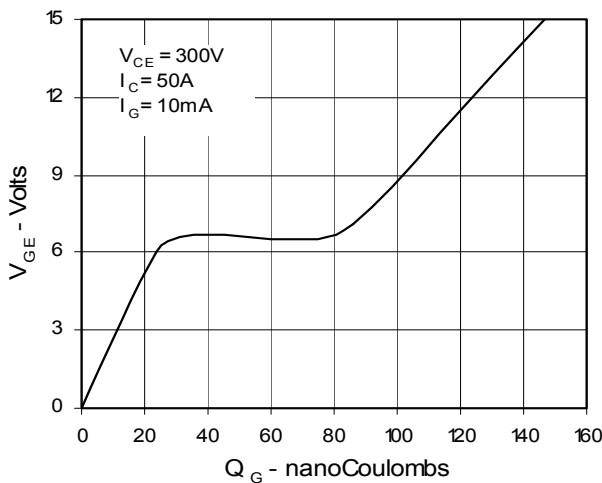
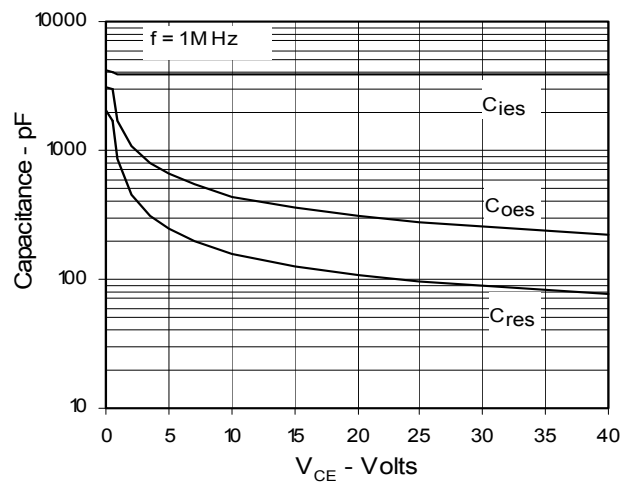
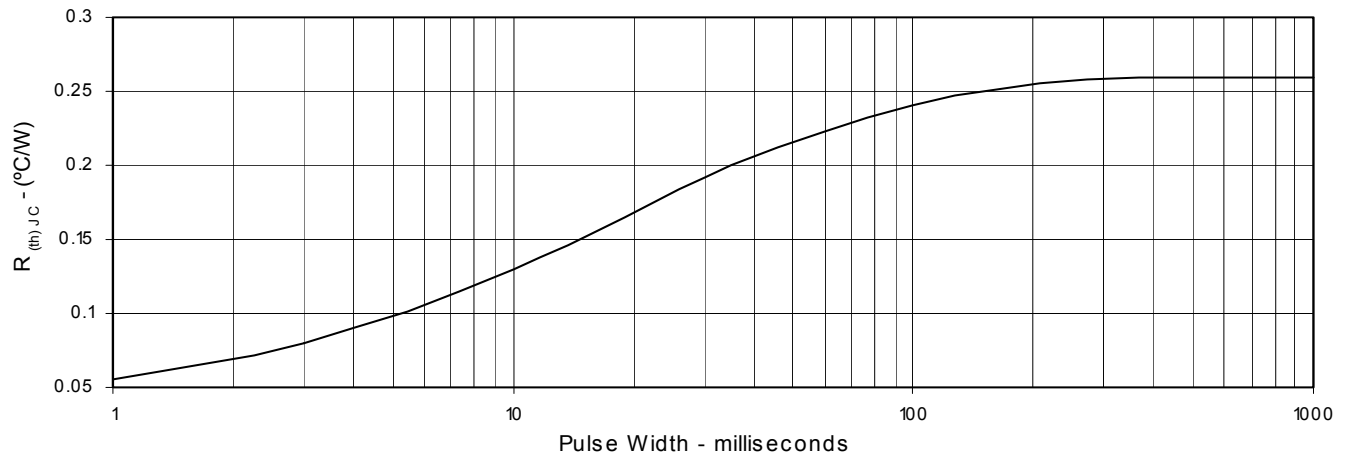

Fig. 12. Capacitance



IXYS reserves the right to change limits, test conditions, and dimensions.

Fig. 13. Maximum Transient Thermal Resistance





Disclaimer Notice - Information furnished is believed to be accurate and reliable. However, users should independently evaluate the suitability of and test each product selected for their own applications. Littelfuse products are not designed for, and may not be used in, all applications. Read complete Disclaimer Notice at www.littelfuse.com/disclaimer-electronics.