

# HiPerFAST™ IGBT with Diode

## C2-Class High Speed IGBTs

**IXGK 60N60C2D1**  
**IXGX 60N60C2D1**

**V<sub>CES</sub> = 600 V**  
**I<sub>C25</sub> = 75 A**  
**V<sub>CE(sat)</sub> = 2.5 V**  
**t<sub>fi(typ)</sub> = 35 ns**

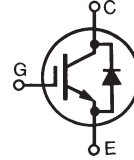

Symbol	Test Conditions	Maximum Ratings	
V <sub>CES</sub>	T <sub>J</sub> = 25°C to 150°C	600	V
V <sub>CGR</sub>	T <sub>J</sub> = 25°C to 150°C; R <sub>GE</sub> = 1 MΩ	600	V
V <sub>GES</sub>	Continuous	±20	V
V <sub>GEM</sub>	Transient	±30	V
I <sub>C25</sub>	T <sub>C</sub> = 25°C (limited by leads)	75	A
I <sub>C110</sub>	T <sub>C</sub> = 110°C	60	A
I <sub>F110</sub>	T <sub>C</sub> = 110°C	48	A
I <sub>CM</sub>	T <sub>C</sub> = 25°C, 1 ms	300	A
<b>SSOA</b> <b>(RBSOA)</b>	V <sub>GE</sub> = 15 V, T <sub>vj</sub> = 125°C, R <sub>G</sub> = 10 Ω Clamped inductive load @ V <sub>CE</sub> ≤ 600 V	I <sub>CM</sub> = 100	A
P <sub>C</sub>	T <sub>C</sub> = 25°C	480	W
T <sub>J</sub>		-55 ... +150	°C
T <sub>JM</sub>		150	°C
T <sub>stg</sub>		-55 ... +150	°C
M <sub>d</sub>	Mounting torque, TO-264	1.13/10	Nm/lb.in.
<b>Weight</b>	TO-264	10	g
	PLUS247	6	g
Maximum lead temperature for soldering 1.6 mm (0.062 in.) from case for 10 s		300	°C

**TO-264 AA  
(IXGK)**

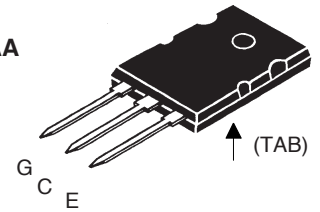

**PLUS247  
(IXGX)**

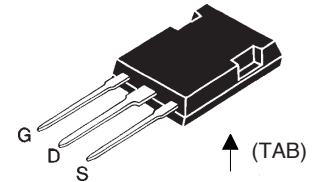

G = Gate      C = Collector  
E = Emitter    Tab = Collector

### Features

- Very high frequency IGBT and anti-parallel FRED in one package
- Square RBSOA
- High current handling capability
- MOS Gate turn-on for drive simplicity
- Fast Recovery Epitaxial Diode (FRED) with soft recovery and low I<sub>RM</sub>

### Applications

- Switch-mode and resonant-mode power supplies
- Uninterruptible power supplies (UPS)
- DC choppers
- AC motor speed control
- DC servo and robot drives

### Advantages

- Space savings (two devices in one package)
- Easy to mount with 1 screw

Symbol	Test Conditions	Characteristic Values (T <sub>J</sub> = 25°C unless otherwise specified)		
		Min.	Typ.	Max.
V <sub>GE(th)</sub>	I <sub>C</sub> = 250 μA, V <sub>CE</sub> = V <sub>GE</sub>	3.0		5.0 V
I <sub>CES</sub>	V <sub>CE</sub> = V <sub>CES</sub> V <sub>GE</sub> = 0 V	T <sub>J</sub> = 25°C		650 μA
		T <sub>J</sub> = 125°C		5 mA
I <sub>GES</sub>	V <sub>CE</sub> = 0 V, V <sub>GE</sub> = ±20 V			±100 nA
V <sub>CE(sat)</sub>	I <sub>C</sub> = 50 A, V <sub>GE</sub> = 15 V Note 1	T <sub>J</sub> = 25°C		2.1 V
		T <sub>J</sub> = 125°C		1.8 V

Symbol	Test Conditions	Characteristic Values		
		Min.	Typ.	Max.
$g_{fs}$	$I_C = 50 \text{ A}; V_{CE} = 10 \text{ V}$ , Note 1	40	58	S
$C_{ies}$	$V_{CE} = 25 \text{ V}, V_{GE} = 0 \text{ V}, f = 1 \text{ MHz}$		3900	pF
$C_{oes}$		280	pF	
$C_{res}$		97	pF	
$Q_g$	$I_C = 50 \text{ A}, V_{GE} = 15 \text{ V}, V_{CE} = 0.5 V_{CES}$		146	nC
$Q_{ge}$		28	nC	
$Q_{gc}$		50	nC	
$t_{d(on)}$	<b>Inductive load, <math>T_J = 25^\circ\text{C}</math></b> $I_C = 50 \text{ A}, V_{GE} = 15 \text{ V}$ $V_{CE} = 400 \text{ V}, R_G = R_{off} = 2.0 \Omega$		18	ns
$E_{on}$		0.4	mJ	
$t_{ri}$		25	ns	
$t_{d(off)}$		95	150	ns
$t_{fi}$		35	ns	
$E_{off}$		0.48	0.8	mJ
$t_{d(on)}$	<b>Inductive load, <math>T_J = 125^\circ\text{C}</math></b> $I_C = 50 \text{ A}, V_{GE} = 15 \text{ V}$ $V_{CE} = 400 \text{ V}, R_G = R_{off} = 2.0 \Omega$		18	ns
$t_{ri}$		25	ns	
$E_{on}$		0.9	mJ	
$t_{d(off)}$		130	ns	
$t_{fi}$		80	ns	
$E_{off}$		1.2	mJ	
$R_{thJC}$			0.26	K/W
$R_{thCK}$		0.15		K/W

### Reverse Diode (FRED)

Symbol	Test Conditions	Characteristic Values		
		min.	typ.	max.
$V_F$	$I_F = 60 \text{ A}, V_{GE} = 0 \text{ V}$ , Note 1			2.1 V
		$T_J = 150^\circ\text{C}$		1.4
$I_{RM}$	$I_F = 60 \text{ A}, V_{GE} = 0 \text{ V}, -di_F/dt = 100 \text{ A}/\mu\text{s}$ $V_R = 100 \text{ V}$			8.3 A
$t_{rr}$	$I_F = 1 \text{ A}; -di/dt = 200 \text{ A/ms}; V_R = 30 \text{ V}$	35		ns
$R_{thJC}$				0.65 K/W

Note 1: Pulse test,  $t \leq 300 \mu\text{s}$ , duty cycle  $\leq 2\%$

IXYS reserves the right to change limits, test conditions, and dimensions.

IXYS MOSFETs and IGBTs are covered by 4,835,592 4,931,844 5,049,961 5,237,481 6,162,665 6,404,065 B1 6,683,344 6,727,585  
one or more of the following U.S. patents: 4,850,072 5,017,508 5,063,307 5,381,025 6,259,123 B1 6,534,343 6,710,405 B2 6,759,692  
4,881,106 5,034,796 5,187,117 5,486,715 6,306,728 B1 6,583,505 6,710,463 6771478 B2

### TO-264 AA Outline

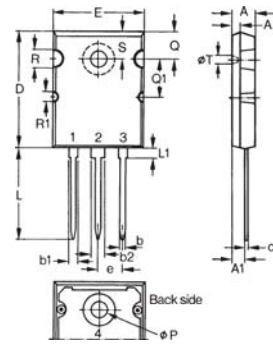

Dim.	Millimeter		Inches	
	Min.	Max.	Min.	Max.
A	4.82	5.13	.190	.202
A1	2.54	2.89	.100	.114
A2	2.00	2.10	.079	.083
b	1.12	1.42	.044	.056
b1	2.39	2.69	.094	.106
b2	2.90	3.09	.114	.122
c	0.53	0.83	.021	.033
D	25.91	26.16	1.020	1.030
E	19.81	19.96	.780	.786
e	5.46 BSC		.215 BSC	
J	0.00	0.25	.000	.010
K	0.00	0.25	.000	.010
L	20.32	20.83	.800	.820
L1	2.29	2.59	.090	.102
P	3.17	3.66	.125	.144
Q	6.07	6.27	.239	.247
Q1	8.38	8.69	.330	.342
R	3.81	4.32	.150	.170
R1	1.78	2.29	.070	.090
S	6.04	6.30	.238	.248
T	1.57	1.83	.062	.072

### PLUS247 Outline

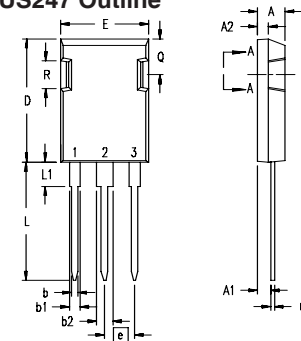

Terminals: 1 - Gate  
2 - Drain (Collector)  
3 - Source (Emitter)  
4 - Drain (Collector)

Dim.	Millimeter		Inches	
	Min.	Max.	Min.	Max.
A	4.83	5.21	.190	.205
A <sub>1</sub>	2.29	2.54	.090	.100
A <sub>2</sub>	1.91	2.16	.075	.085
b	1.14	1.40	.045	.055
b <sub>1</sub>	1.91	2.13	.075	.084
b <sub>2</sub>	2.92	3.12	.115	.123
C	0.61	0.80	.024	.031
D	20.80	21.34	.819	.840
E	15.75	16.13	.620	.635
e	5.45 BSC		.215 BSC	
L	19.81	20.32	.780	.800
L1	3.81	4.32	.150	.170
Q	5.59	6.20	.220	0.244
R	4.32	4.83	.170	.190

**Fig. 1. Output Characteristics @ 25°C**

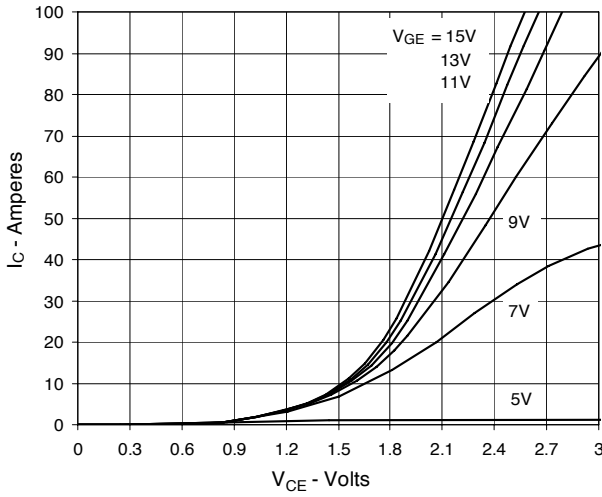

**Fig. 2. Extended Output Characteristics @ 25°C**

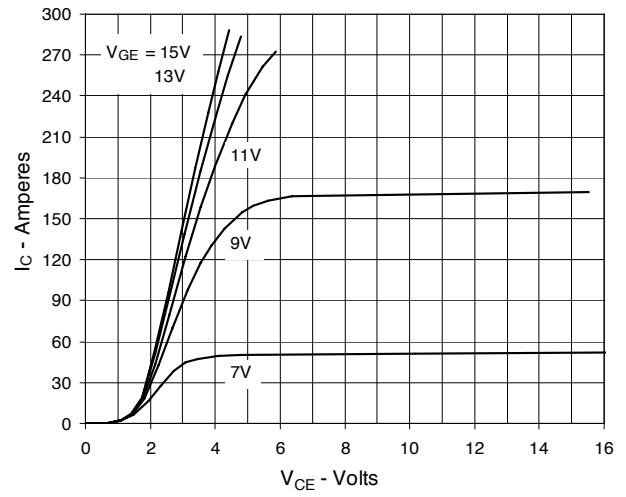

**Fig. 3. Output Characteristics @ 125°C**

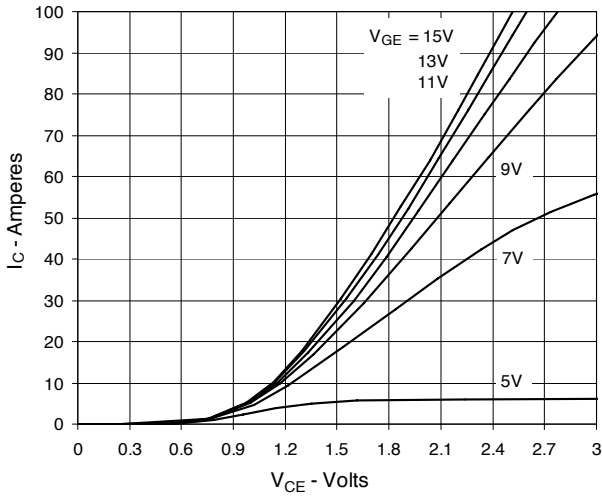

**Fig. 4. Dependence of  $V_{CE(sat)}$  on Junction Temperature**

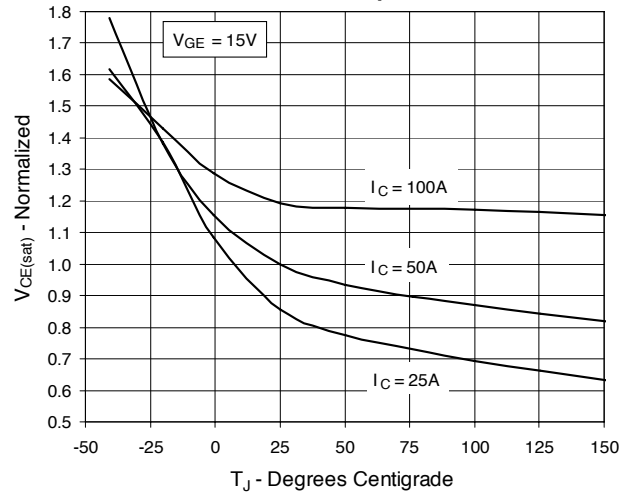

**Fig. 5. Collector-to-Emitter Voltage vs. Gate-to-Emitter Voltage**

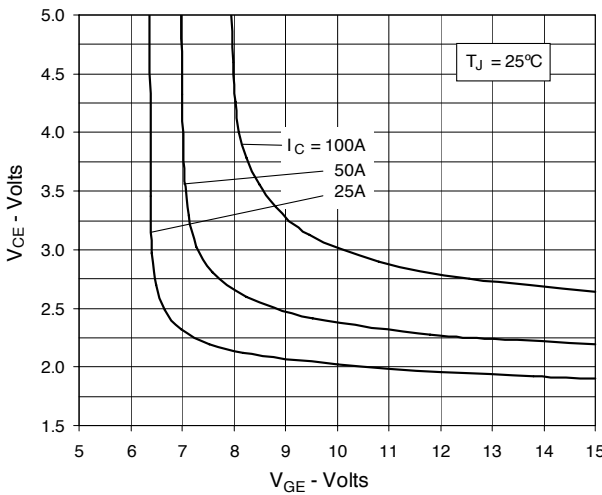

**Fig. 6. Input Admittance**

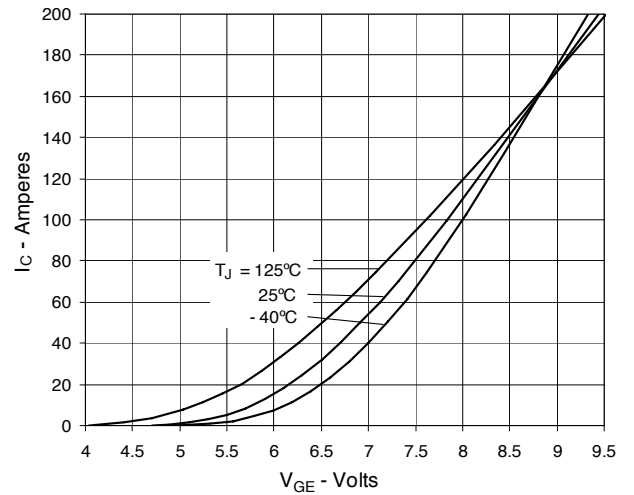

Fig. 7. Transconductance

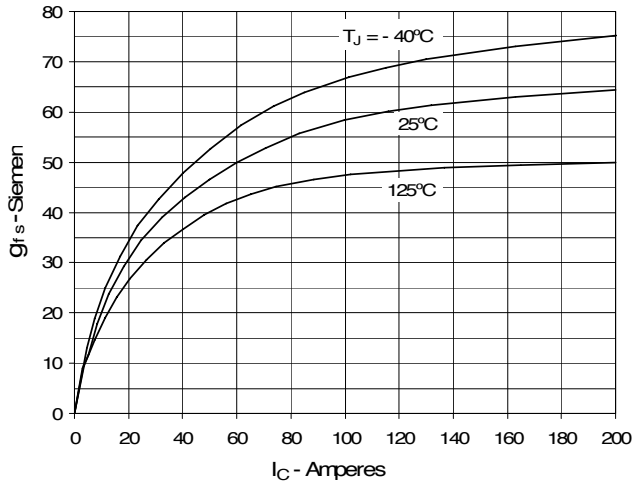

Fig. 8. Inductive Switching Energy Loss vs. Gate Resistance

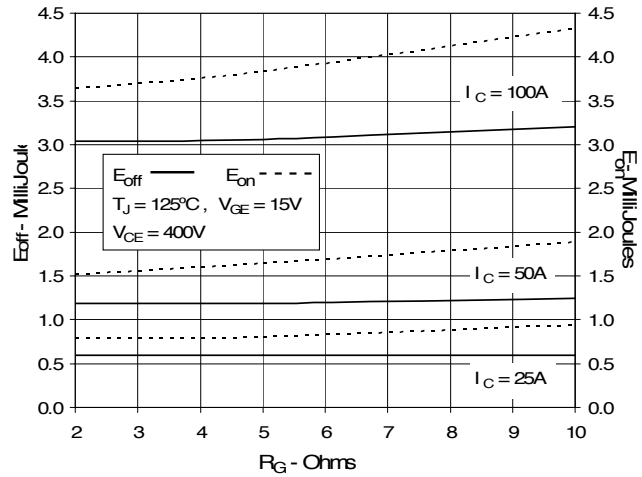

Fig. 9. Inductive Switching Energy Loss vs. Collector Current

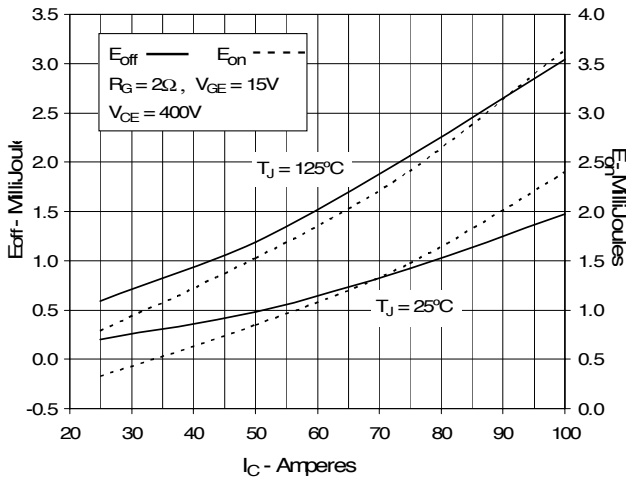

Fig. 10. Inductive Switching Energy Loss vs. Junction Temperature

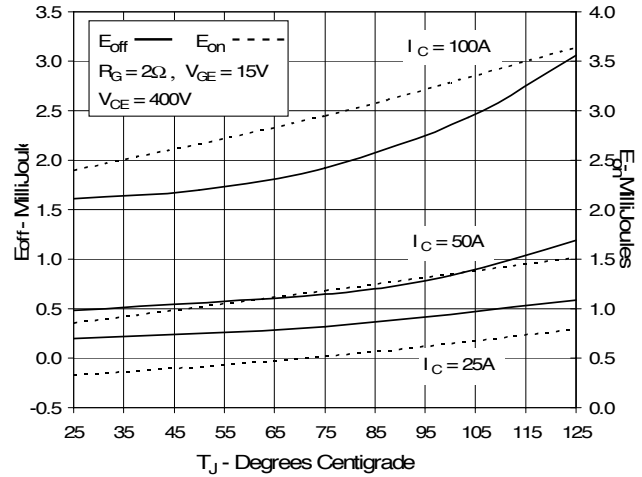

Fig. 11. Inductive Turn-off Switching Times vs. Gate Resistance

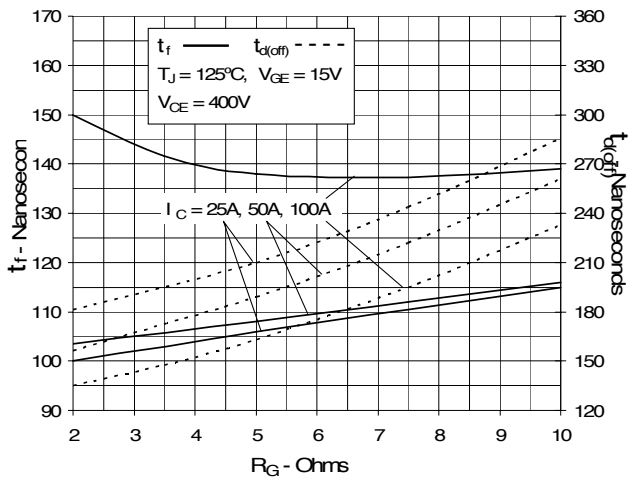
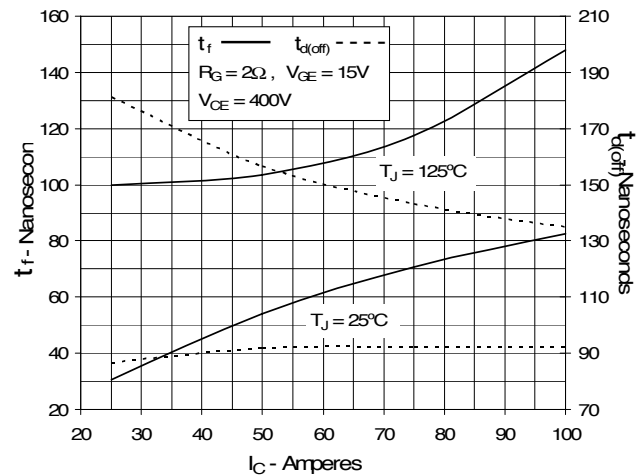
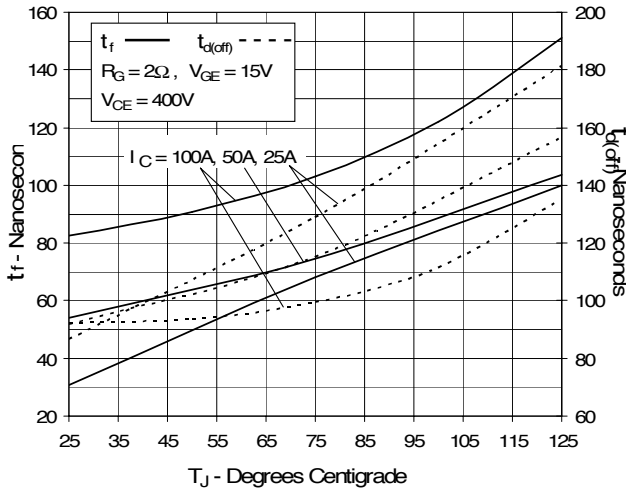

Fig. 12. Inductive Turn-off Switching Times vs. Collector Current



**Fig. 13. Inductive Turn-off**  
Switching Times vs. Junction Temperature



**Fig. 14. Inductive Turn-on**  
Switching Times vs. Gate Resistance

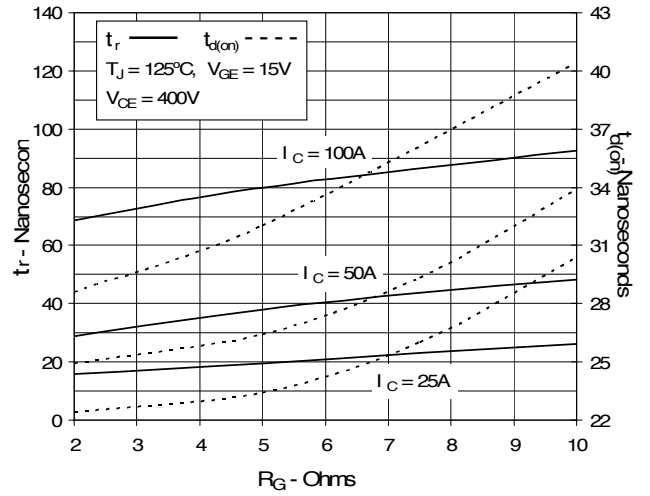

**Fig. 15. Inductive Turn-on**  
Switching Times vs. Collector Current

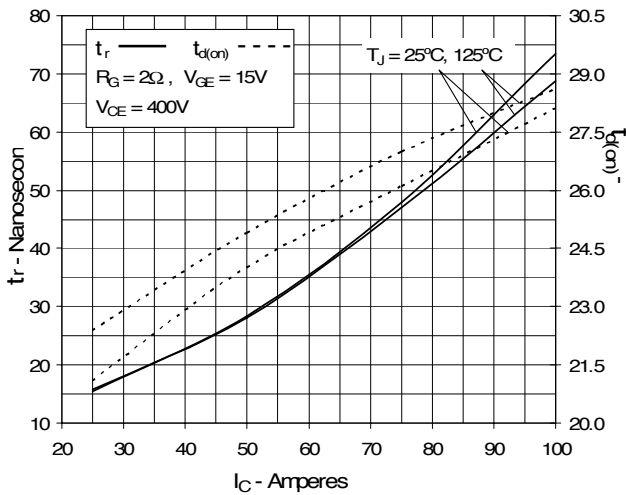

**Fig. 16. Inductive Turn-on**  
Switching Times vs. Junction Temperature

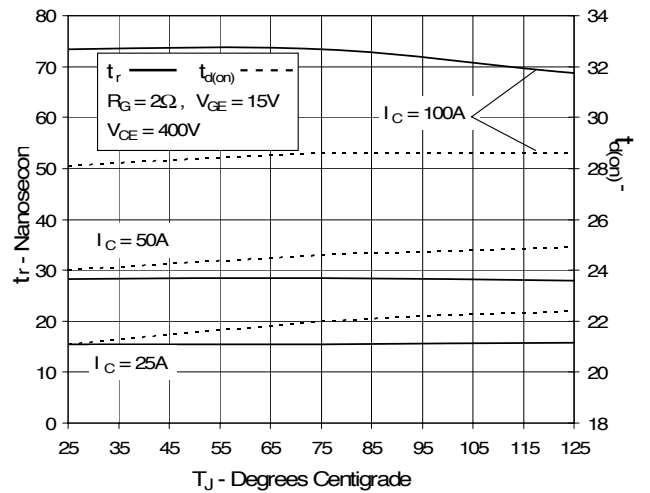

**Fig. 17. Gate Charge**

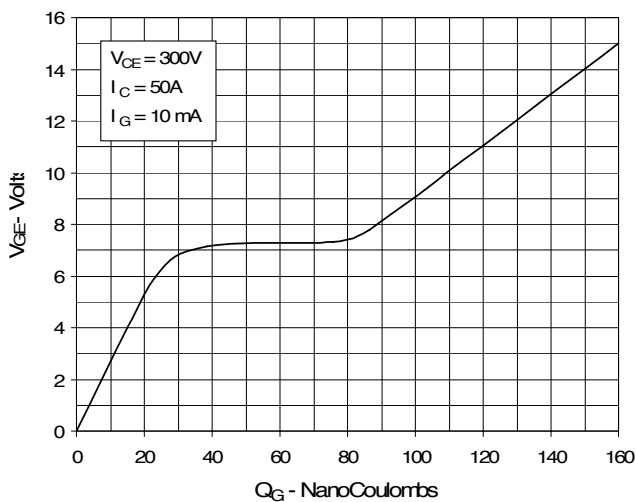

**Fig. 18. Capacitance**

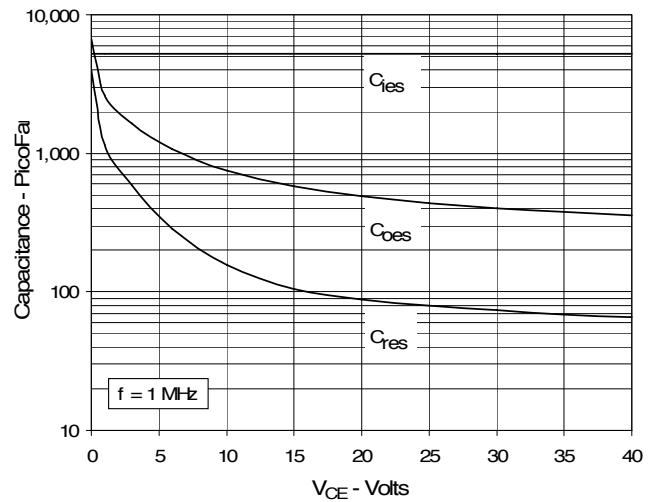

Fig. 19. Reverse-Bias Safe Operating Area

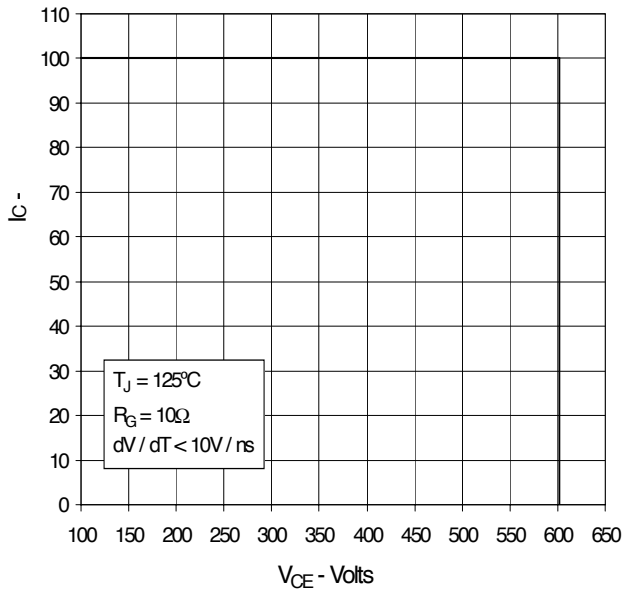
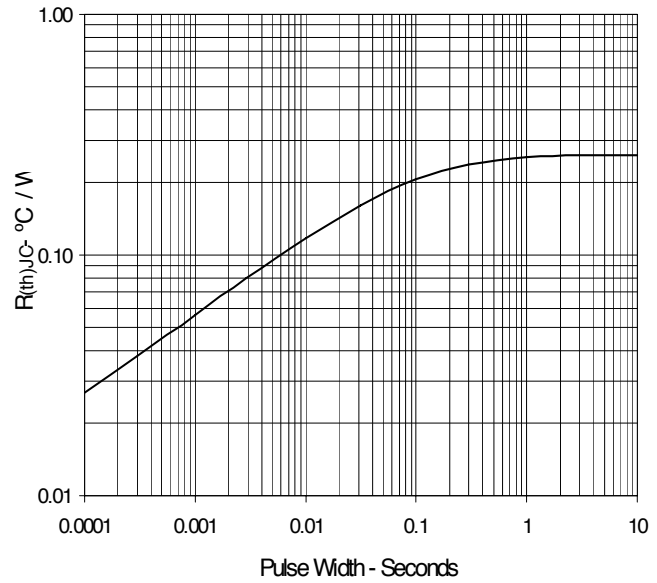

Fig. 20. Maximum Transient Thermal Resistance



### Diode's Curves

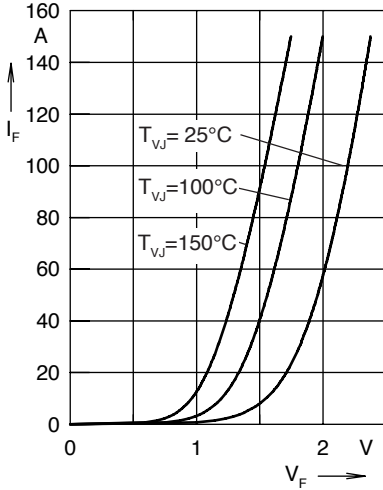

Fig. 21. Forward current  $I_F$  versus  $V_F$

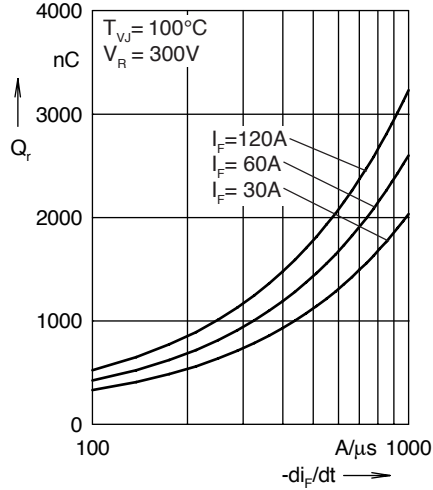

Fig. 22. Reverse recovery charge  $Q_r$  versus  $-di_F/dt$

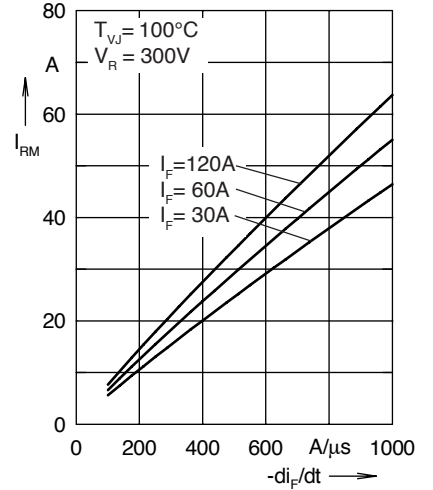

Fig. 23. Peak reverse current  $I_{RM}$  versus  $-di_F/dt$

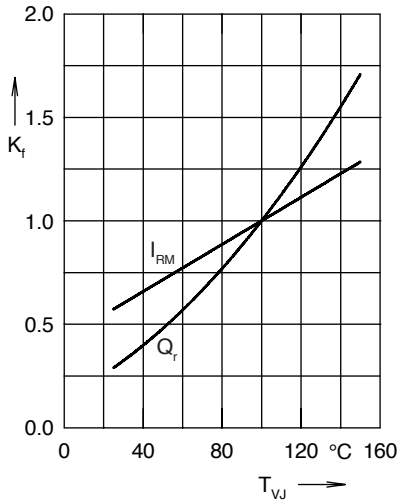

Fig. 24. Dynamic parameters  $Q_r$ ,  $I_{RM}$  versus  $T_{VJ}$

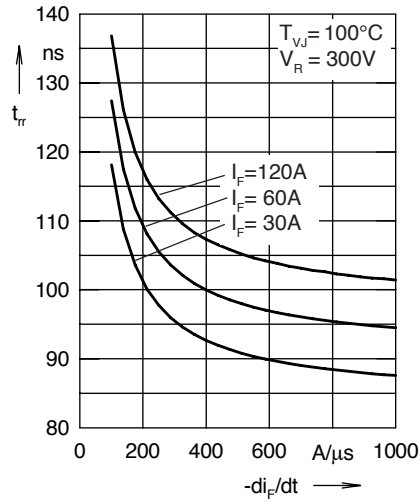

Fig. 25. Recovery time  $t_{rr}$  versus  $-di_F/dt$

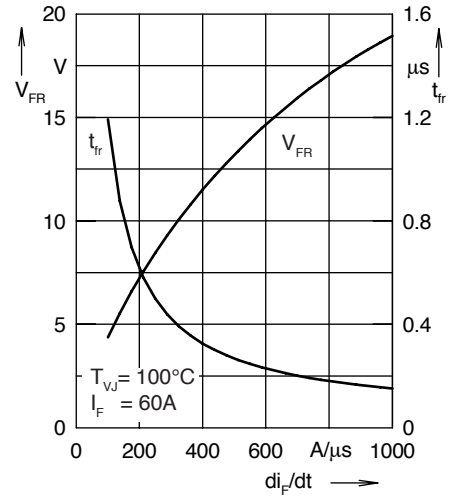

Fig. 26. Peak forward voltage  $V_{FR}$  and  $t_{fr}$  versus  $di_F/dt$

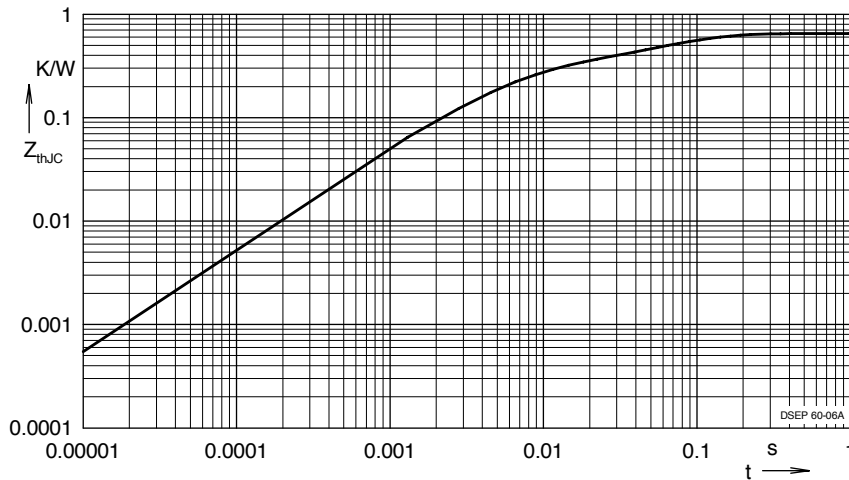

Fig. 27. Transient thermal resistance junction to case

Constants for  $Z_{thJC}$  calculation:

i	$R_{thi}$ (K/W)	$t_i$ (s)
1	0.324	0.0052
2	0.125	0.0003
3	0.201	0.0385

Note: Fig. 15 through Fig. 20 show typical values



---

Disclaimer Notice - Information furnished is believed to be accurate and reliable. However, users should independently evaluate the suitability of and test each product selected for their own applications. Littelfuse products are not designed for, and may not be used in, all applications. Read complete Disclaimer Notice at [www.littelfuse.com/disclaimer-electronics](http://www.littelfuse.com/disclaimer-electronics).