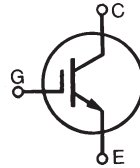


# High Voltage IGBT

**IXGH 20N120B**  
**IXGT 20N120B**

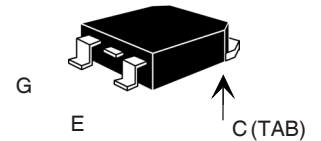
**$V_{CES} = 1200 \text{ V}$**   
 **$I_{C25} = 40 \text{ A}$**   
 **$V_{CE(sat)} = 3.4 \text{ V}$**   
 **$t_{fi(typ)} = 160 \text{ ns}$**

Preliminary Data Sheet

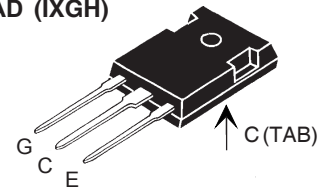


Symbol	Test Conditions	Maximum Ratings	
$V_{CES}$	$T_J = 25^\circ\text{C to } 150^\circ\text{C}$	1200	V
$V_{CGR}$	$T_J = 25^\circ\text{C to } 150^\circ\text{C}; R_{GE} = 1 \text{ M}\Omega$	1200	V
$V_{GES}$	Continuous	$\pm 20$	V
$V_{GEM}$	Transient	$\pm 30$	V
$I_{C25}$	$T_C = 25^\circ\text{C}$	40	A
$I_{C110}$	$T_C = 110^\circ\text{C}$	20	A
$I_{CM}$	$T_C = 25^\circ\text{C}, 1 \text{ ms}$	80	A
<b>SSOA (RBSOA)</b>	$V_{GE} = 15 \text{ V}, T_{VJ} = 125^\circ\text{C}, R_G = 10 \Omega$ Clamped inductive load	$I_{CM} = 80$ @ $0.8 V_{CES}$	A
$P_C$	$T_C = 25^\circ\text{C}$	190	W
$T_J$		-55 ... +150	$^\circ\text{C}$
$T_{JM}$		150	$^\circ\text{C}$
$T_{stg}$		-55 ... +150	$^\circ\text{C}$
Maximum Lead temperature for soldering		300	$^\circ\text{C}$
1.6 mm (0.062 in.) from case for 10 s			
Maximum Tab temperature for soldering SMD devices for 10 s		260	$^\circ\text{C}$
$M_d$	Mounting torque (M3) (TO-247)	1.13/10Nm/lb.in.	
<b>Weight</b>	TO-247 AD	6	g
	TO-268	4	g

**TO-268 (IXGT)**



**TO-247 AD (IXGH)**



G = Gate, C = Collector,  
E = Emitter, TAB = Collector

## Features

- High Voltage IGBT for resonant power supplies
  - Induction heating
  - Rice cookers
- International standard packages JEDEC TO-268 surface and JEDEC TO-247 AD
- Low switching losses, low  $V_{(sat)}$
- MOS Gate turn-on
  - drive simplicity

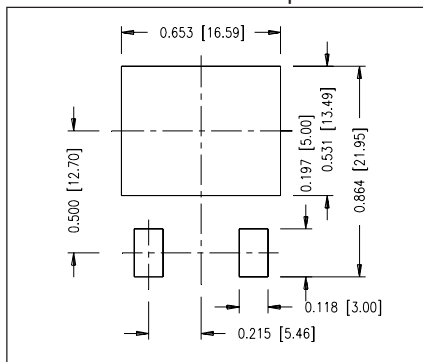
## Advantages

- High power density
- Suitable for surface mounting
- Easy to mount with 1 screw, (isolated mounting screw hole)

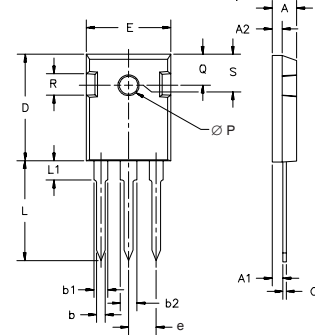
Symbol	Test Conditions	Characteristic Values		
		(T <sub>J</sub> = 25°C, unless otherwise specified)		
		min.	typ.	max.
$BV_{CES}$	$I_C = 250 \mu\text{A}, V_{GE} = 0 \text{ V}$	1200		
$V_{GE(th)}$	$I_C = 250 \mu\text{A}, V_{CE} = V_{GE}$	2.5		5
$I_{CES}$	$V_{CE} = V_{CES}, T_J = 25^\circ\text{C}$			50
$I_{GES}$	$V_{CE} = 0 \text{ V}, V_{GE} = \pm 20 \text{ V}$			$\pm 100$
$V_{CE(sat)}$	$I_C = 20 \text{ A}, V_{GE} = 15 \text{ V}, T_J = 125^\circ\text{C}$	2.9	3.4	V
		2.8	3.8	V

Symbol	Test Conditions	Characteristic Values ( $T_J = 25^\circ\text{C}$ , unless otherwise specified)			
		min.	typ.	max.	
$g_{fs}$	$I_C = 20\text{A}; V_{CE} = 10\text{V}$ , Pulse test, $t \leq 300\ \mu\text{s}$ , duty cycle $\leq 2\%$	12	18	S	
$C_{ies}$	$V_{CE} = 25\text{V}, V_{GE} = 0\text{V}, f = 1\text{MHz}$		1700	pF	
$C_{oes}$			95	pF	
$C_{res}$			35	pF	
$Q_g$	$I_C = 20\text{A}, V_{GE} = 15\text{V}, V_{CE} = 0.5 V_{CES}$		72	nC	
$Q_{ge}$			12	nC	
$Q_{gc}$			27	nC	
$t_{d(on)}$	<b>Inductive load, <math>T_J = 25^\circ\text{C}</math></b> $I_C = 20\text{A}, V_{GE} = 15\text{V}$ $V_{CE} = 0.8 V_{CES}, R_G = R_{off} = 10\ \Omega$		25	ns	
$t_{ri}$			15	ns	
$t_{d(off)}$			150	280	ns
$t_{fi}$			160	320	ns
$E_{off}$			2.1	3.5	mJ
$t_{d(on)}$	<b>Inductive load, <math>T_J = 125^\circ\text{C}</math></b> $I_C = 20\text{A}, V_{GE} = 15\text{V}$ $V_{CE} = 0.8 V_{CES}, R_G = R_{off} = 10\ \Omega$		25	ns	
$t_{ri}$			18	ns	
$E_{on}$			0.9	mJ	
$t_{d(off)}$			270	ns	
$t_{fi}$			360	ns	
$E_{off}$		3.5	mJ		
$R_{thJC}$				0.65 K/W	
$R_{thCK}$	(TO-247)	0.25		K/W	

### Min Recommended Footprint

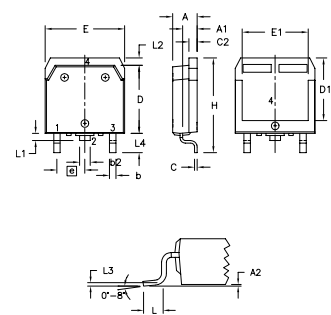


### TO-247 AD Outline



Dim.	Millimeter		Inches	
	Min.	Max.	Min.	Max.
A	4.7	5.3	.185	.209
A <sub>1</sub>	2.2	2.54	.087	.102
A <sub>2</sub>	2.2	2.6	.087	.104
b	1.0	1.4	.040	.055
b <sub>1</sub>	1.65	2.13	.065	.084
b <sub>2</sub>	2.87	3.12	.113	.123
C	.4	.8	.016	.031
D	20.80	21.46	.819	.845
E	15.75	16.26	.610	.640
e	5.20	5.72	0.205	0.225
L	19.81	20.32	.780	.800
L1		4.50		.177
∅P	3.55	3.65	.140	.144
Q	5.89	6.40	0.232	0.252
R	4.32	5.49	.170	.216
S	6.15	BSC	242	BSC

### TO-268 Outline



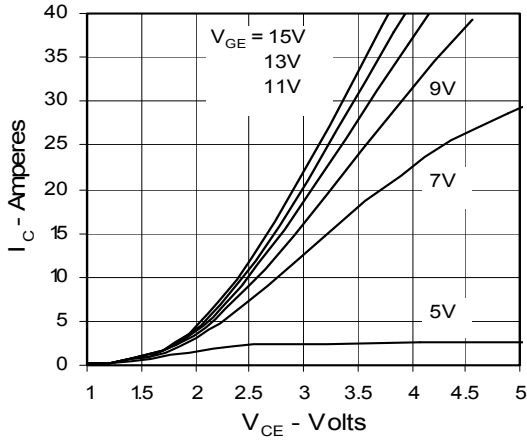
Dim.	Millimeter		Inches	
	Min.	Max.	Min.	Max.
A	4.9	5.1	.193	.201
A <sub>1</sub>	2.7	2.9	.106	.114
A <sub>2</sub>	.02	.25	.001	.010
b	1.15	1.45	.045	.057
b <sub>2</sub>	1.9	2.1	.075	.083
C	.4	.65	.016	.026
D	13.80	14.00	.543	.551
E	15.85	16.05	.624	.632
E <sub>1</sub>	13.3	13.6	.524	.535
e	5.45	BSC	.215	BSC
H	18.70	19.10	.736	.752
L	2.40	2.70	.094	.106
L1	1.20	1.40	.047	.055
L2	1.00	1.15	.039	.045
L3		0.25		.010 BSC
L4	3.80	4.10	.150	.161

IXYS reserves the right to change limits, test conditions, and dimensions.

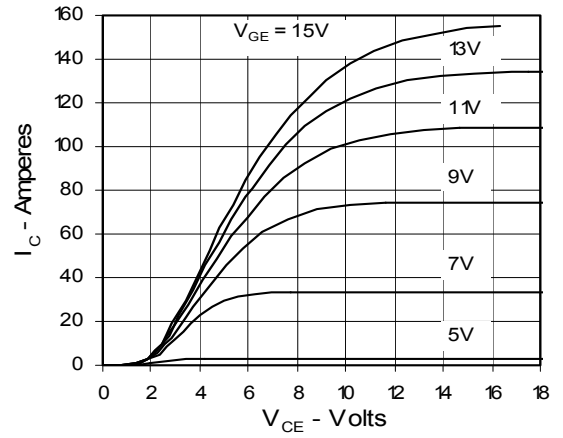
IXYS MOSFETs and IGBTs are covered by one or more of the following U.S. patents:

4,835,592 4,881,106 5,017,508 5,049,961 5,187,117 5,486,715 6,306,728B1 6,259,123B1 6,306,728B1  
4,850,072 4,931,844 5,034,796 5,063,307 5,237,481 5,381,025 6,404,065B1 6,162,665 6,534,343

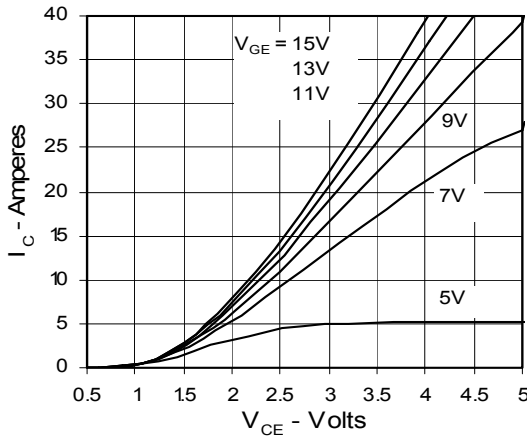
**Fig. 1. Output Characteristics**  
@ 25 Deg. C



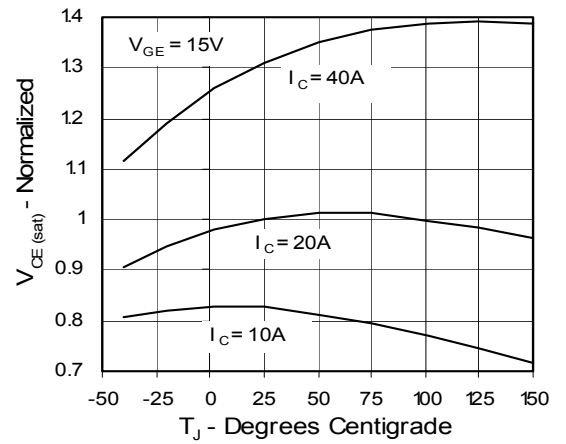
**Fig. 2. Extended Output Characteristics**  
@ 25 deg. C



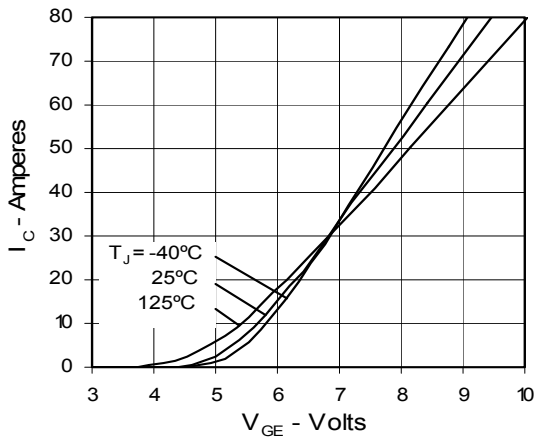
**Fig. 3. Output Characteristics**  
@ 125 Deg. C



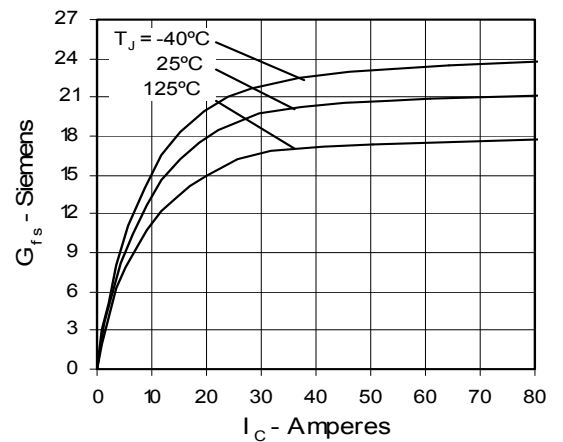
**Fig. 4. Temperature Dependence of  $V_{CE(sat)}$**



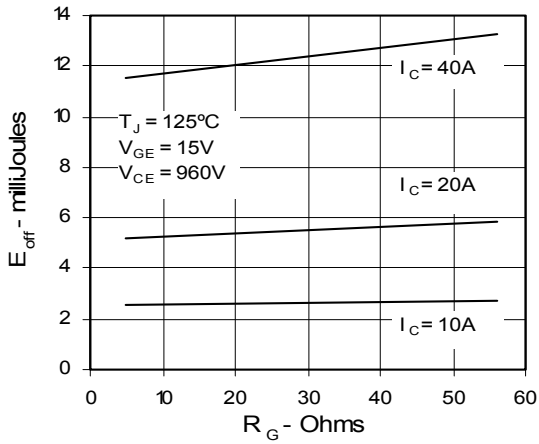
**Fig. 5. Input Admittance**



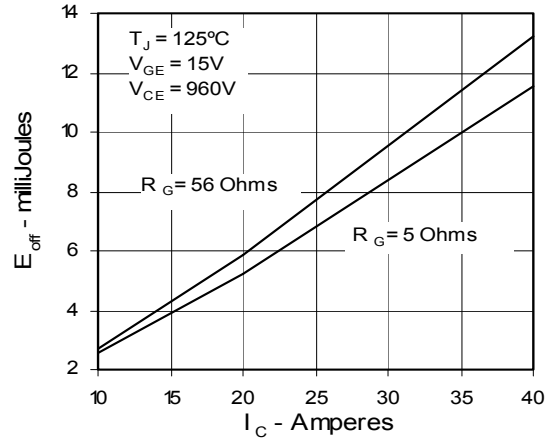
**Fig. 6. Transconductance**



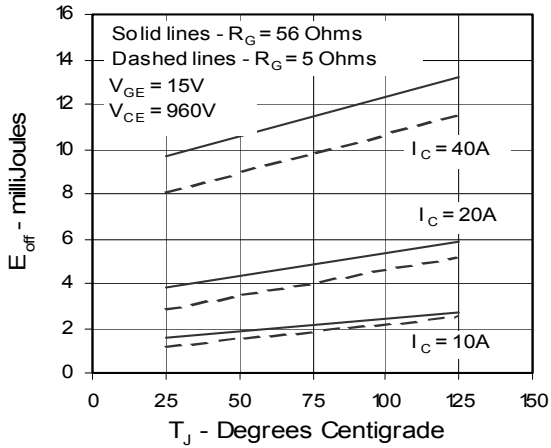
**Fig. 7. Dependence of  $E_{off}$  on  $R_G$**



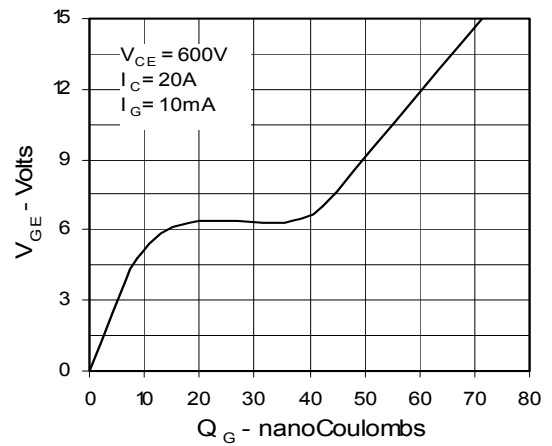
**Fig. 8. Dependence of  $E_{off}$  on  $I_C$**



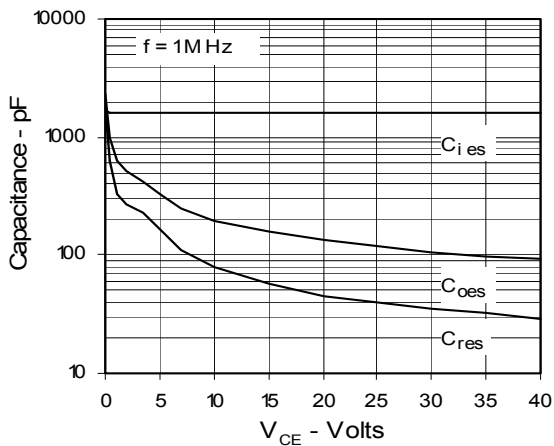
**Fig. 9. Dependence of  $E_{off}$  on Temperature**



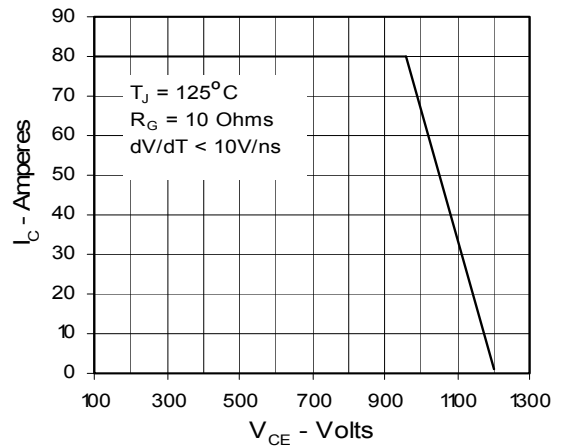
**Fig. 10. Gate Charge**



**Fig. 11. Capacitance**

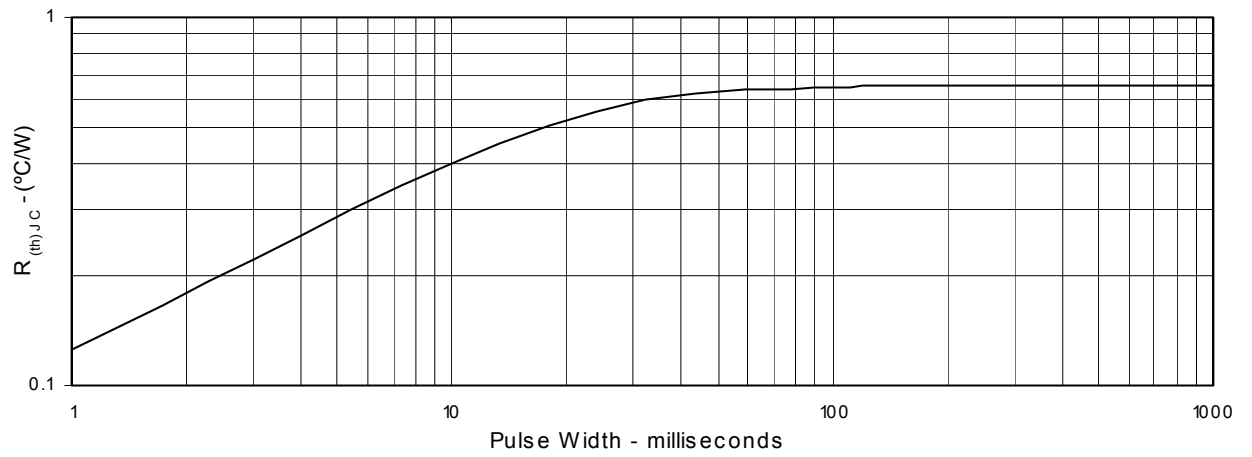


**Fig. 12. Reverse-Bias Safe Operating Area**



IXYS reserves the right to change limits, test conditions, and dimensions.

Fig. 13. Maximum Transient Thermal Resistance





---

Disclaimer Notice - Information furnished is believed to be accurate and reliable. However, users should independently evaluate the suitability of and test each product selected for their own applications. Littelfuse products are not designed for, and may not be used in, all applications. Read complete Disclaimer Notice at [www.littelfuse.com/disclaimer-electronics](http://www.littelfuse.com/disclaimer-electronics).