

XPT IGBT

preliminary

$$V_{CES} = 1200V$$

$$I_{C25} = 20A$$

$$V_{CE(sat)} = 1.8V$$

Copack

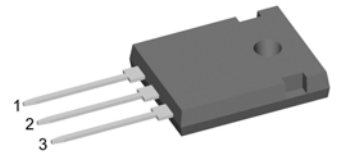
Part number
IXA12IF1200HB

Backside: collector

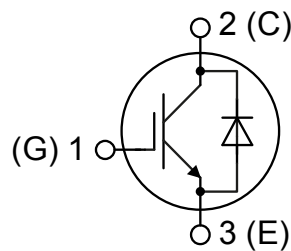
Features / Advantages:

- Easy paralleling due to the positive temperature coefficient of the on-state voltage
- Rugged XPT design (Xtreme light Punch Through) results in:
 - short circuit rated for 10 μ sec.
 - very low gate charge
 - low EMI
 - square RBSOA @ 3x I_c
- Thin wafer technology combined with the XPT design results in a competitive low $V_{CE(sat)}$
- SONIC™ diode
 - fast and soft reverse recovery
 - low operating forward voltage

Applications:

- AC motor drives
- Solar inverter
- Medical equipment
- Uninterruptible power supply
- Air-conditioning systems
- Welding equipment
- Switched-mode and resonant-mode power supplies
- Inductive heating, cookers
- Pumps, Fans

Package: TO-247

- Industry standard outline
- RoHS compliant
- Epoxy meets UL 94V-0

IGBT				Ratings			
Symbol	Definition	Conditions	min.	typ.	max.	Unit	
V_{CES}	collector emitter voltage	$T_{VJ} = 25^{\circ}\text{C}$			1200	V	
V_{GES}	max. DC gate voltage				± 20	V	
V_{GEM}	max. transient gate emitter voltage				± 30	V	
I_{C25}	collector current	$T_C = 25^{\circ}\text{C}$			20	A	
I_{C100}		$T_C = 100^{\circ}\text{C}$			13	A	
P_{tot}	total power dissipation	$T_C = 25^{\circ}\text{C}$			85	W	
$V_{CE(sat)}$	collector emitter saturation voltage	$I_C = 10\text{A}; V_{GE} = 15\text{V}$		1.8	2.1	V	
				2.1		V	
$V_{GE(th)}$	gate emitter threshold voltage	$I_C = 0.3\text{mA}; V_{GE} = V_{CE}$	5.4	5.9	6.5	V	
I_{CES}	collector emitter leakage current	$V_{CE} = V_{CES}; V_{GE} = 0\text{V}$			0.1	mA	
				0.1		mA	
I_{GES}	gate emitter leakage current	$V_{GE} = \pm 20\text{V}$			500	nA	
$Q_{G(on)}$	total gate charge	$V_{CE} = 600\text{V}; V_{GE} = 15\text{V}; I_C = 10\text{A}$		27		nC	
$t_{d(on)}$	turn-on delay time	inductive load $V_{CE} = 600\text{V}; I_C = 10\text{A}$ $V_{GE} = \pm 15\text{V}; R_G = 100\Omega$		70		ns	
t_r	current rise time		$T_{VJ} = 125^{\circ}\text{C}$		40		ns
$t_{d(off)}$	turn-off delay time				250		ns
t_f	current fall time				100		ns
E_{on}	turn-on energy per pulse				1.1		mJ
E_{off}	turn-off energy per pulse				1.1		mJ
RBSOA	reverse bias safe operating area	$V_{GE} = \pm 15\text{V}; R_G = 100\Omega$					
I_{CM}		$V_{CEmax} = 1200\text{V}$			30	A	
SCSOA	short circuit safe operating area	$V_{CEmax} = 900\text{V}$					
t_{sc}	short circuit duration	$V_{CE} = 900\text{V}; V_{GE} = \pm 15\text{V}$			10	μs	
I_{sc}	short circuit current	$R_G = 100\Omega; \text{non-repetitive}$		40		A	
R_{thJC}	thermal resistance junction to case				1.5	K/W	
R_{thCH}	thermal resistance case to heatsink			0.25		K/W	
Diode							
V_{RRM}	max. repetitive reverse voltage	$T_{VJ} = 25^{\circ}\text{C}$			1200	V	
I_{F25}	forward current	$T_C = 25^{\circ}\text{C}$			22	A	
I_{F100}		$T_C = 100^{\circ}\text{C}$			14	A	
V_F	forward voltage	$I_F = 10\text{A}$			2.20	V	
				1.95		V	
I_R	reverse current	$V_R = V_{RRM}$			*	mA	
	* not applicable, see Ices value above				*	mA	
Q_{rr}	reverse recovery charge	$V_R = 600\text{V}$ $-di_F/dt = -250\text{A}/\mu\text{s}$ $I_F = 10\text{A}; V_{GE} = 0\text{V}$		1.3		μC	
I_{RM}	max. reverse recovery current		$T_{VJ} = 125^{\circ}\text{C}$		10.5		A
t_{rr}	reverse recovery time				350		ns
E_{rec}	reverse recovery energy				0.35		mJ
R_{thJC}	thermal resistance junction to case				1.8	K/W	
R_{thCH}	thermal resistance case to heatsink			0.25		K/W	

preliminary

Package TO-247			Ratings			
Symbol	Definition	Conditions	min.	typ.	max.	Unit
I_{RMS}	RMS current	per terminal			70	A
T_{VJ}	virtual junction temperature		-40		150	°C
T_{op}	operation temperature		-40		125	°C
T_{stg}	storage temperature		-40		150	°C
Weight				6		g
M_D	mounting torque		0.8		1.2	Nm
F_C	mounting force with clip		20		120	N

Product Marking

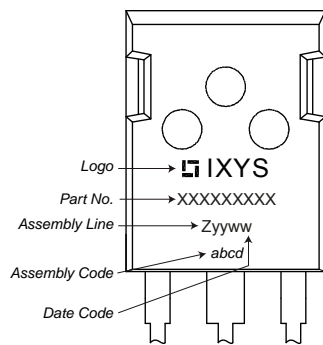

Part number

- I = IGBT
- X = XPT IGBT
- A = Gen 1 / std
- 12 = Current Rating [A]
- IF = Copack
- 1200 = Reverse Voltage [V]
- HB = TO-247AD (3)

Ordering	Part Number	Marking on Product	Delivery Mode	Quantity	Code No.
Standard	IXA12IF1200HB	IXA12IF1200HB	Tube	30	508453

Similar Part	Package	Voltage class
IXA12IF1200PB	TO-220AB (3)	1200
IXA12IF1200TC	TO-268AA (D3Pak) (2)	1200

Equivalent Circuits for Simulation

* on die level

$T_{VJ} = 150\text{ }^{\circ}\text{C}$

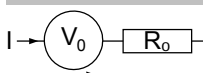

	IGBT	Diode	
$V_{0\max}$ threshold voltage	1.1	1.25	V
$R_{0\max}$ slope resistance *	153	85	mΩ

Outlines TO-247

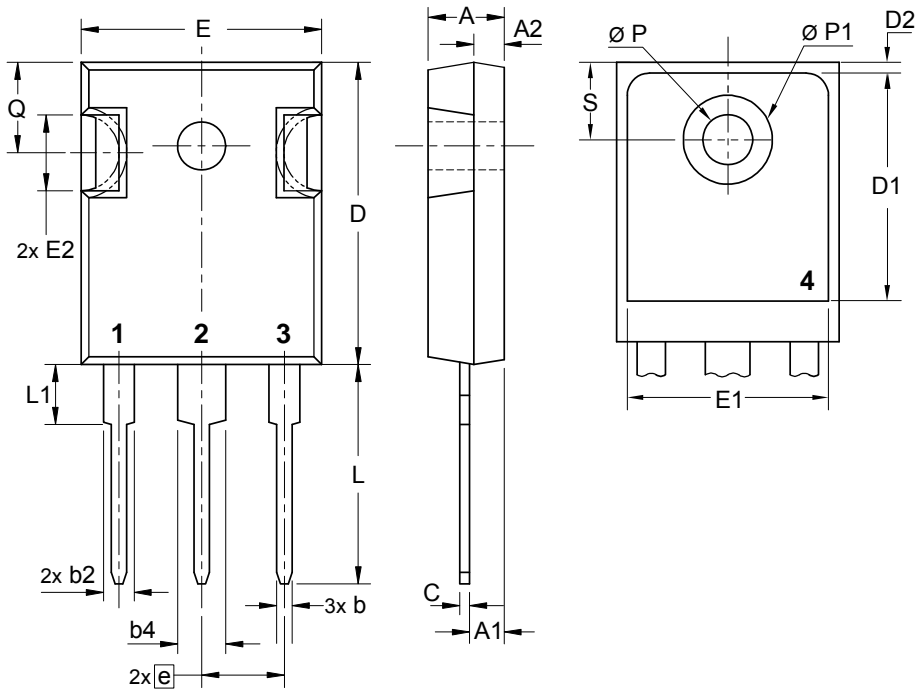

Sym.	Inches		Millimeter	
	min.	max.	min.	max.
A	0.185	0.209	4.70	5.30
A1	0.087	0.102	2.21	2.59
A2	0.059	0.098	1.50	2.49
D	0.819	0.845	20.79	21.45
E	0.610	0.640	15.48	16.24
E2	0.170	0.216	4.31	5.48
e	0.215 BSC		5.46 BSC	
L	0.780	0.800	19.80	20.30
L1	-	0.177	-	4.49
Ø P	0.140	0.144	3.55	3.65
Q	0.212	0.244	5.38	6.19
S	0.242 BSC		6.14 BSC	
b	0.039	0.055	0.99	1.40
b2	0.065	0.094	1.65	2.39
b4	0.102	0.135	2.59	3.43
c	0.015	0.035	0.38	0.89
D1	0.515	-	13.07	-
D2	0.020	0.053	0.51	1.35
E1	0.530	-	13.45	-
Ø P1	-	0.29	-	7.39

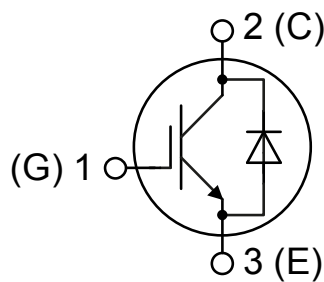

IGBT

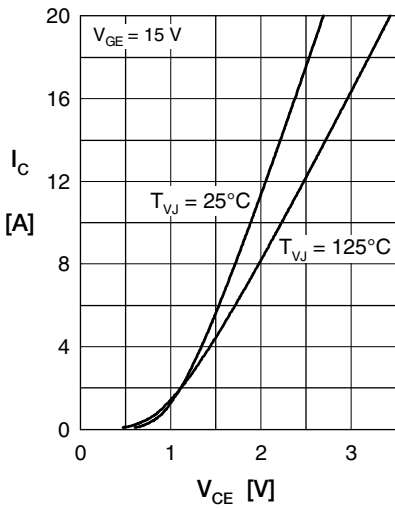

Fig. 1 Typ. output characteristics

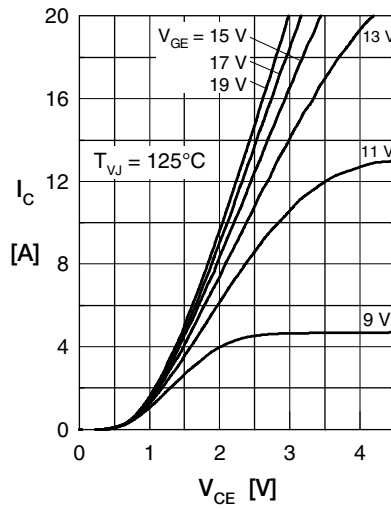

Fig. 2 Typ. output characteristics

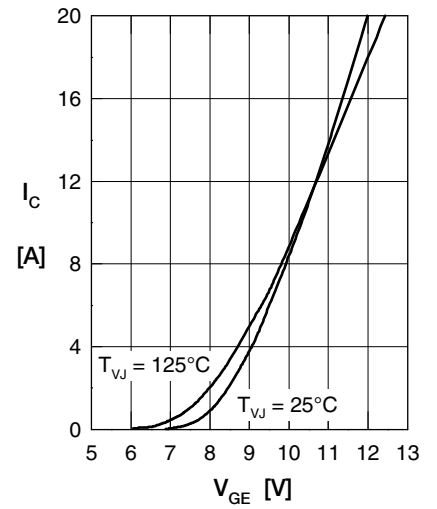

Fig. 3 Typ. transfer characteristics

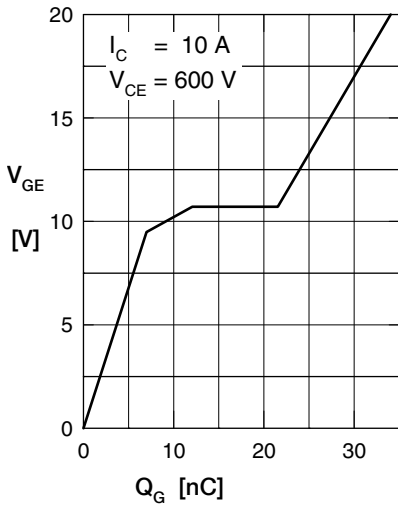

Fig. 4 Typ. turn-on gate charge

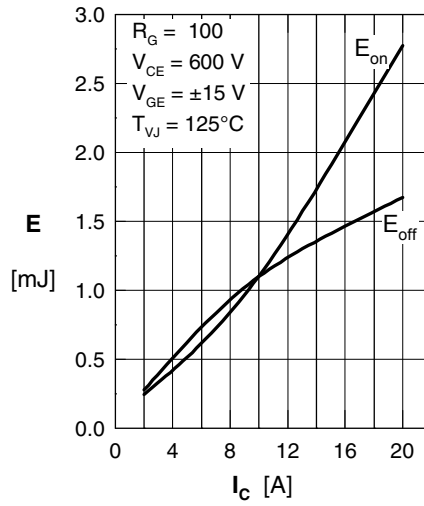

Fig. 5 Typ. switching energy vs. collector current

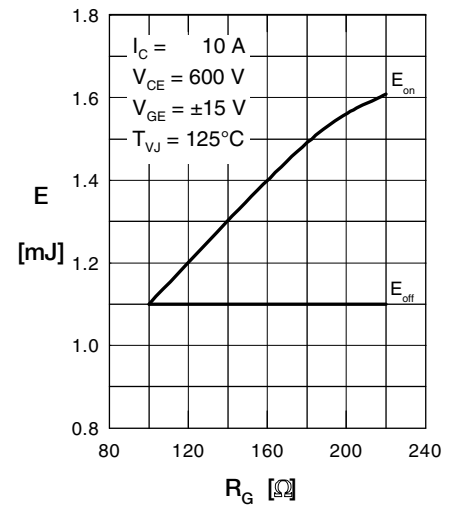

Fig. 6 Typ. switching energy vs. gate resistance

Fig. 7 Typ. transient thermal impedance junction to case

Diode

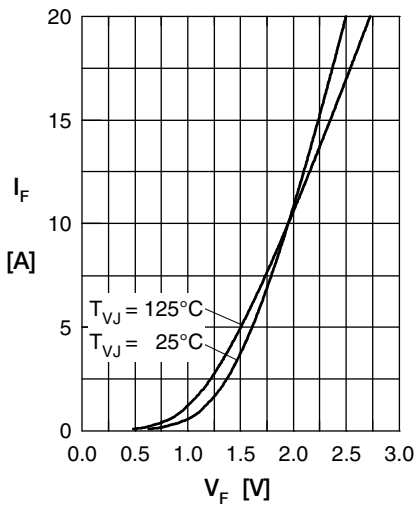

Fig. 1 Typ. forward current versus V_F

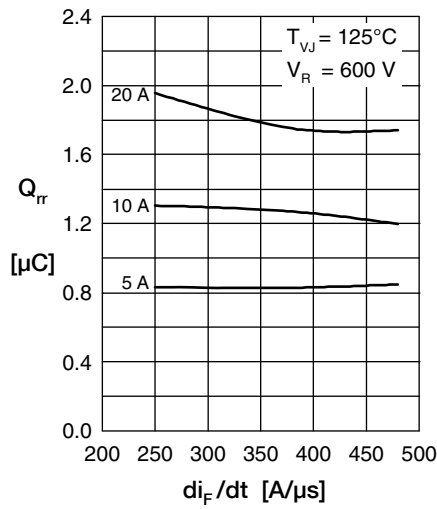

Fig. 2 Typical reverse recov. charge Q_{rr} versus di_F/dt

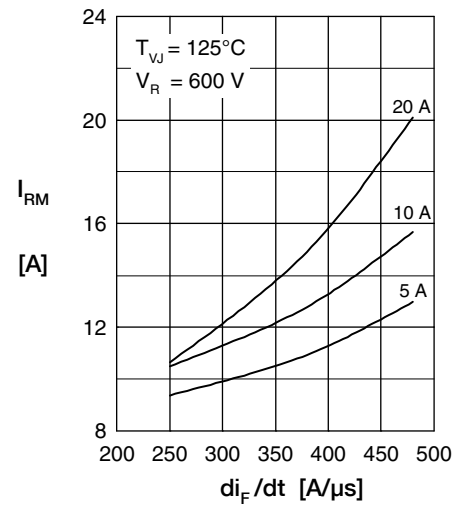

Fig. 3 Typ. peak reverse current I_{RM} versus di_F/dt

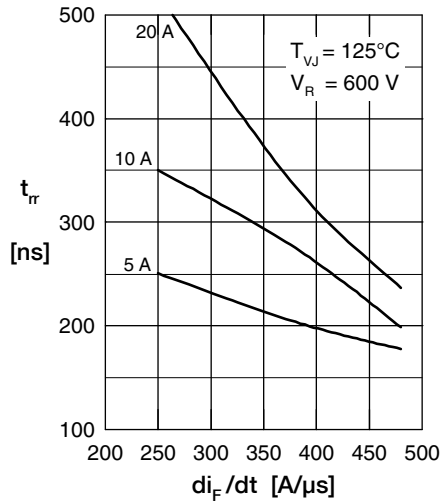

Fig. 4 Dynamic parameters Q_{rr} , I_{RM} versus T_{VJ}

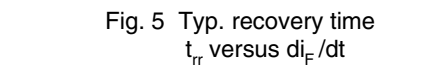

Fig. 5 Typ. recovery time t_{rr} versus di_F/dt

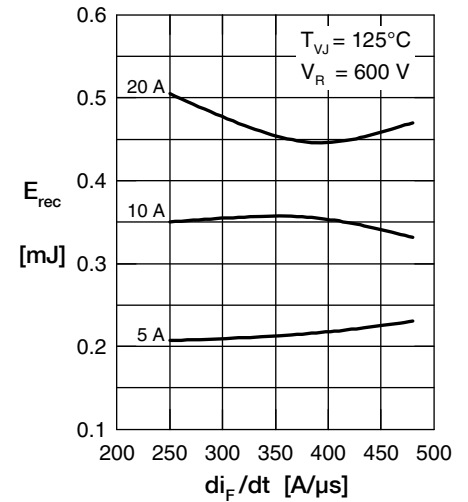

Fig. 6 Typ. recovery energy E_{rec} vs. di_F/dt

Fig. 7 Typ. transient thermal impedance junction to case



Disclaimer Notice - Information furnished is believed to be accurate and reliable. However, users should independently evaluate the suitability of and test each product selected for their own applications. Littelfuse products are not designed for, and may not be used in, all applications. Read complete Disclaimer Notice at www.littelfuse.com/disclaimer-electronics.