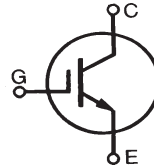

**XPT™ 600V IGBTs**  
**GenX3™**
**IXXK200N60B3**  
**IXXX200N60B3**

 Extreme Light Punch Through  
 IGBT for 10-30kHz Switching

$$V_{CES} = 600V$$

$$I_{C110} = 200A$$

$$V_{CE(sat)} \leq 1.7V$$

$$t_{fi(typ)} = 110ns$$

Symbol	Test Conditions	Maximum Ratings	
$V_{CES}$	$T_J = 25^\circ C$ to $175^\circ C$	600	V
$V_{CGR}$	$T_J = 25^\circ C$ to $175^\circ C$ , $R_{GE} = 1M\Omega$	600	V
$V_{GES}$	Continuous	$\pm 20$	V
$V_{GEM}$	Transient	$\pm 30$	V
$I_{C25}$	$T_C = 25^\circ C$ (Chip Capability)	380	A
$I_{LRMS}$	Leads Current Limit	160	A
$I_{C110}$	$T_C = 110^\circ C$	200	A
$I_{CM}$	$T_C = 25^\circ C$ , 1ms	900	A
$I_A$	$T_C = 25^\circ C$	100	A
$E_{AS}$	$T_C = 25^\circ C$	1	J
<b>SSOA</b> <b>(RBSOA)</b>	$V_{GE} = 15V$ , $T_{VJ} = 150^\circ C$ , $R_G = 1\Omega$ Clamped Inductive Load	$I_{CM} = 400$ @ $V_{CE} \leq V_{CES}$	A
$t_{sc}$ <b>(SCSOA)</b>	$V_{GE} = 15V$ , $V_{CE} = 360V$ , $T_J = 150^\circ C$ $R_G = 10\Omega$ , Non Repetitive	10	$\mu s$
$P_C$	$T_C = 25^\circ C$	1630	W
$T_J$		-55 ... +175	$^\circ C$
$T_{JM}$		175	$^\circ C$
$T_{stg}$		-55 ... +175	$^\circ C$
$T_L$	Maximum Lead Temperature for Soldering	300	$^\circ C$
$T_{SOLD}$	1.6 mm (0.062in.) from Case for 10s	260	$^\circ C$
$M_d$	Mounting Torque (TO-264)	1.13/10	Nm/lb.in.
$F_C$	Mounting Force (PLUS247)	20..120 / 4.5..27	N/lb.
<b>Weight</b>	TO-264	10	g
	PLUS247	6	g

TO-264 (IXXK)



PLUS247 (IXXX)

 G = Gate  
 C = Collector

 E = Emitter  
 Tab = Collector

**Features**

- International Standard Packages
- Optimized for 10-30kHz Switching
- Square RBSOA
- Avalanche Rated
- Short Circuit Capability
- High Current Handling Capability

**Advantages**

- High Power Density
- Low Gate Drive Requirement

**Applications**

- Power Inverters
- UPS
- Motor Drives
- SMPS
- PFC Circuits
- Battery Chargers
- Welding Machines
- Lamp Ballasts

Symbol	Test Conditions ( $T_J = 25^\circ C$ , Unless Otherwise Specified)	Characteristic Values		
		Min.	Typ.	Max.
$BV_{CES}$	$I_C = 250\mu A$ , $V_{GE} = 0V$	600		V
$V_{GE(th)}$	$I_C = 250\mu A$ , $V_{CE} = V_{GE}$	3.5		6.0 V
$I_{CES}$	$V_{CE} = V_{CES}$ , $V_{GE} = 0V$ $T_J = 150^\circ C$			50 $\mu A$ 3 mA
$I_{GES}$	$V_{CE} = 0V$ , $V_{GE} = \pm 20V$			$\pm 200$ nA
$V_{CE(sat)}$	$I_C = 100A$ , $V_{GE} = 15V$ , Note 1 $T_J = 150^\circ C$		1.40 1.58	V V

**Symbol Test Conditions**

( $T_J = 25^\circ\text{C}$  Unless Otherwise Specified)

**Characteristic Values**

		Min.	Typ.	Max.	
$g_{fs}$	$I_C = 60\text{A}, V_{CE} = 10\text{V}, \text{Note 1}$	27	45		S
$C_{ies}$	$V_{CE} = 25\text{V}, V_{GE} = 0\text{V}, f = 1\text{MHz}$		9970		pF
$C_{oes}$			570		pF
$C_{res}$			183		pF
$Q_{g(on)}$	$I_C = 200\text{A}, V_{GE} = 15\text{V}, V_{CE} = 0.5 \cdot V_{CES}$		315		nC
$Q_{ge}$			98		nC
$Q_{gc}$			130		nC
$t_{d(on)}$	<b>Inductive load, <math>T_J = 25^\circ\text{C}</math></b> $I_C = 100\text{A}, V_{GE} = 15\text{V}$ $V_{CE} = 360\text{V}, R_G = 1\Omega$ Note 2		48		ns
$t_{ri}$			100		ns
$E_{on}$			2.85		mJ
$t_{d(off)}$			160		ns
$t_{fi}$			110		ns
$E_{off}$		2.90	4.40		mJ
$t_{d(on)}$	<b>Inductive load, <math>T_J = 150^\circ\text{C}</math></b> $I_C = 100\text{A}, V_{GE} = 15\text{V}$ $V_{CE} = 360\text{V}, R_G = 1\Omega$ Note 2		46		ns
$t_{ri}$			94		ns
$E_{on}$			4.40		mJ
$t_{d(off)}$			180		ns
$t_{fi}$			215		ns
$E_{off}$		3.45		mJ	
$R_{thJC}$				0.092	$^\circ\text{C}/\text{W}$
$R_{thCS}$		0.15			$^\circ\text{C}/\text{W}$

**Notes:**

1. Pulse test,  $t \leq 300\mu\text{s}$ , duty cycle,  $d \leq 2\%$ .
2. Switching times & energy losses may increase for higher  $V_{CE}$  (clamp),  $T_J$  or  $R_G$ .

**PRELIMINARY TECHNICAL INFORMATION**

The product presented herein is under development. The Technical Specifications offered are derived from a subjective evaluation of the design, based upon prior knowledge and experience, and constitute a "considered reflection" of the anticipated result. IXYS reserves the right to change limits, test conditions, and dimensions without notice.

**TO-264 Outline**

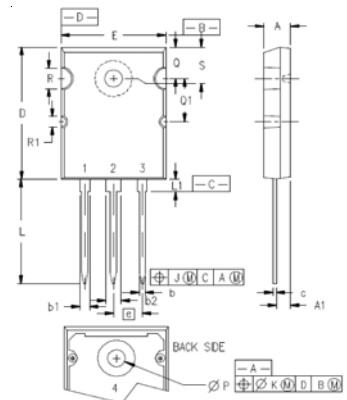

Terminals: 1 = Gate  
2,4 = Collector  
3 = Emitter

SYM	INCHES		MILLIMETERS	
	MIN	MAX	MIN	MAX
A	.185	.209	4.70	5.31
A1	.102	.118	2.59	3.00
b	.037	.055	0.94	1.40
b1	.087	.102	2.21	2.59
b2	.110	.126	2.79	3.20
c	.017	.029	0.43	0.74
D	1.007	1.047	25.58	26.59
E	.760	.799	19.30	20.29
e	.215 BSC		5.46 BSC	
J	.000	.010	0.00	0.25
K	.000	.010	0.00	0.25
L	.779	.842	19.79	21.39
L1	.087	.102	2.21	2.59
ØP	.122	.138	3.10	3.51
Q	.240	.256	6.10	6.50
Q1	.330	.346	8.38	8.79
ØR	.155	.187	3.94	4.75
ØR1	.085	.093	2.16	2.36
S	.243	.253	6.17	6.43

**PLUS247™ Outline**

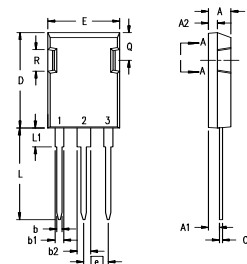

Terminals: 1 - Gate  
2 - Collector  
3 - Emitter

Dim.	Millimeter		Inches	
	Min.	Max.	Min.	Max.
A	4.83	5.21	.190	.205
A <sub>1</sub>	2.29	2.54	.090	.100
A <sub>2</sub>	1.91	2.16	.075	.085
b	1.14	1.40	.045	.055
b <sub>1</sub>	1.91	2.13	.075	.084
b <sub>2</sub>	2.92	3.12	.115	.123
C	0.61	0.80	.024	.031
D	20.80	21.34	.819	.840
E	15.75	16.13	.620	.635
e	5.45 BSC		.215 BSC	
L	19.81	20.32	.780	.800
L1	3.81	4.32	.150	.170
Q	5.59	6.20	.220	0.244
R	4.32	4.83	.170	.190

IXYS Reserves the Right to Change Limits, Test Conditions, and Dimensions.

IXYS MOSFETs and IGBTs are covered by one or more of the following U.S. patents:	4,835,592	4,931,844	5,049,961	5,237,481	6,162,665	6,404,065 B1	6,683,344	6,727,585	7,005,734 B2	7,157,338B2
	4,860,072	5,017,508	5,063,307	5,381,025	6,259,123 B1	6,534,343	6,710,405 B2	6,759,692	7,063,975 B2	
	4,881,106	5,034,796	5,187,117	5,486,715	6,306,728 B1	6,583,505	6,710,463	6,771,478 B2	7,071,537	

**Fig. 1. Output Characteristics @  $T_J = 25^\circ\text{C}$**

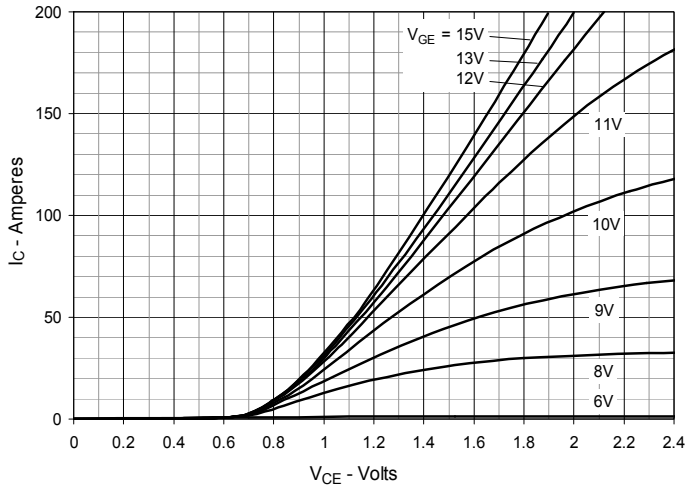

**Fig. 2. Extended Output Characteristics @  $T_J = 25^\circ\text{C}$**

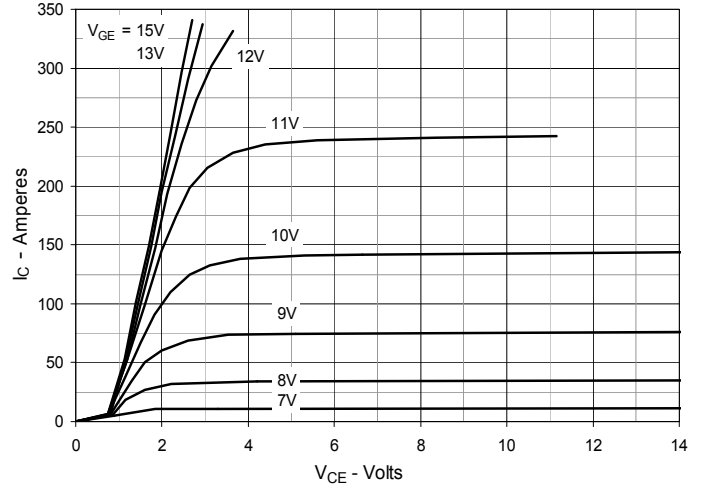

**Fig. 3. Output Characteristics @  $T_J = 150^\circ\text{C}$**

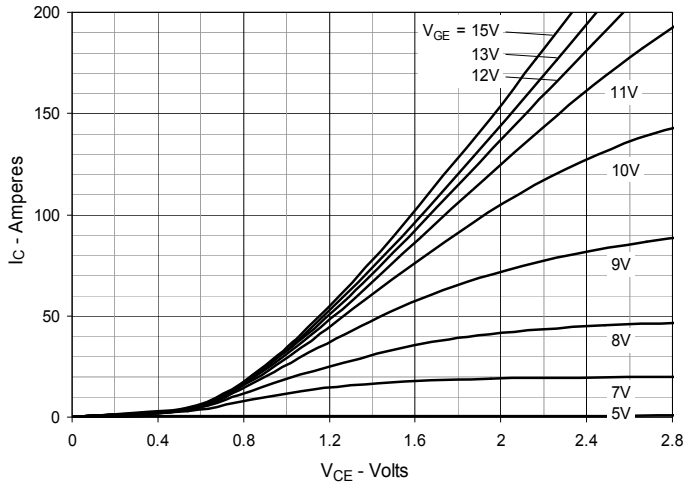

**Fig. 4. Dependence of  $V_{CE(sat)}$  on Junction Temperature**

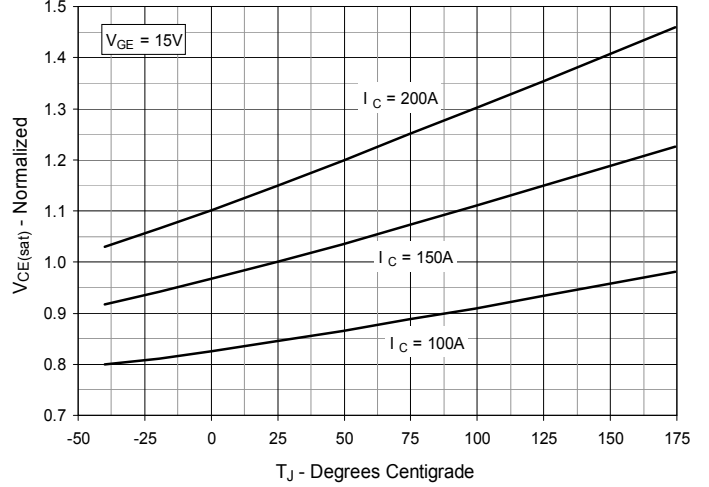

**Fig. 5. Collector-to-Emitter Voltage vs. Gate-to-Emitter Voltage**

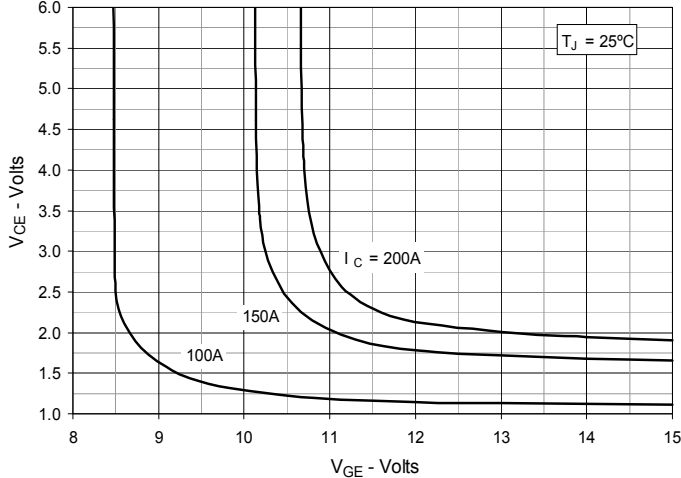

**Fig. 6. Input Admittance**

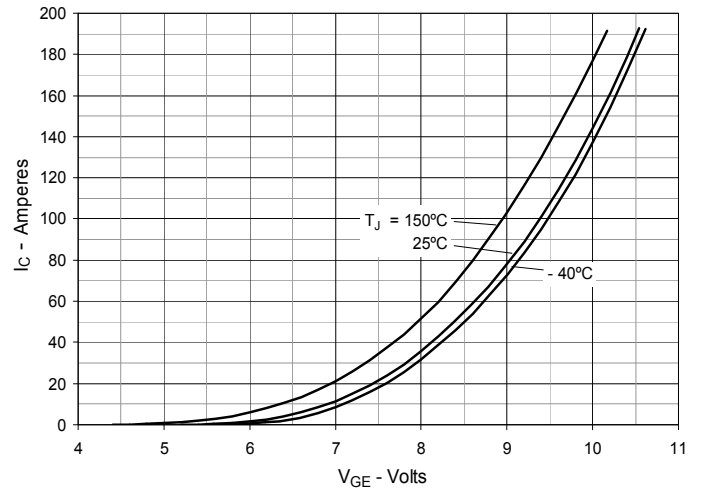

**Fig. 7. Transconductance**

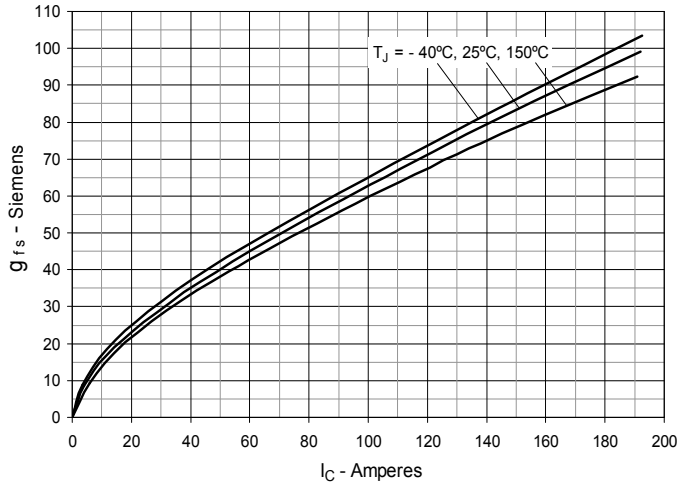

**Fig. 8. Gate Charge**

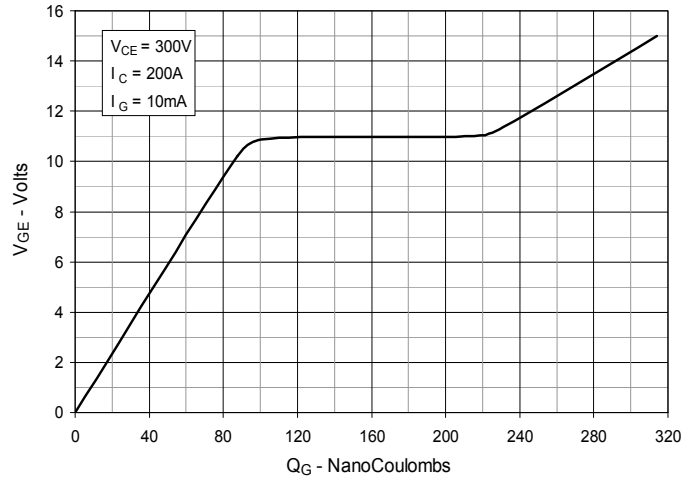

**Fig. 9. Capacitance**

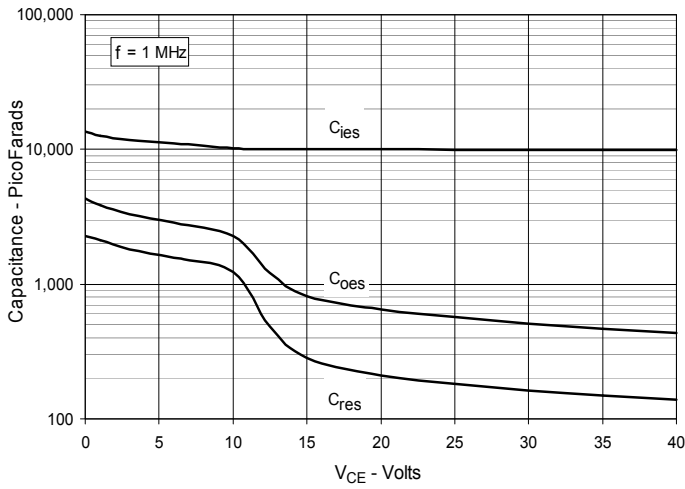

**Fig. 10. Reverse-Bias Safe Operating Area**

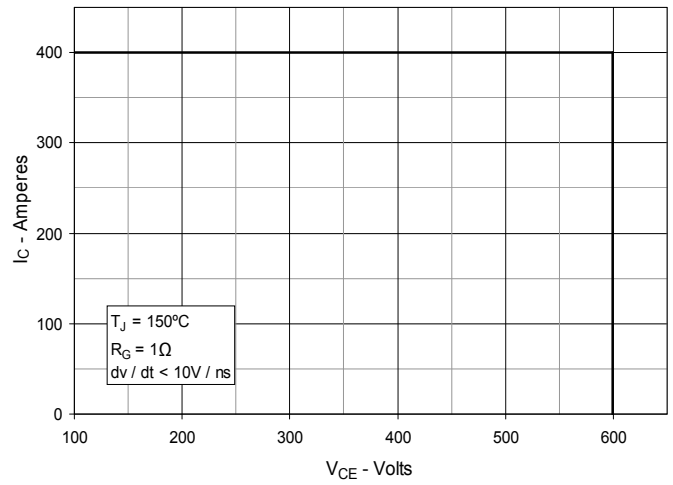

**Fig. 11. Forward-Bias Safe Operating Area**

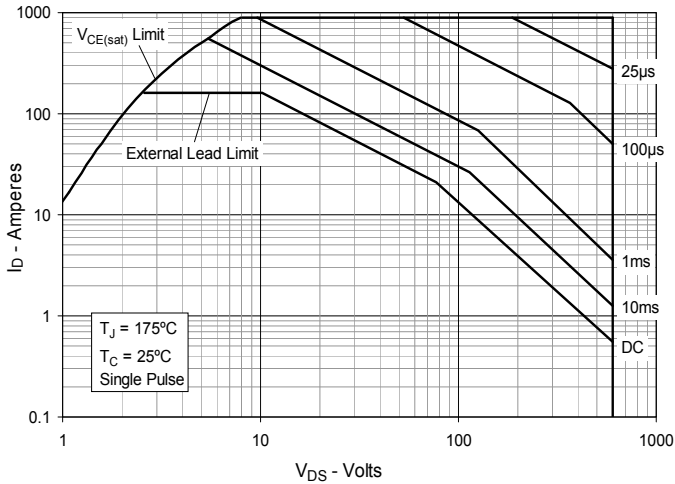

**Fig. 12. Maximum Transient Thermal Impedance**

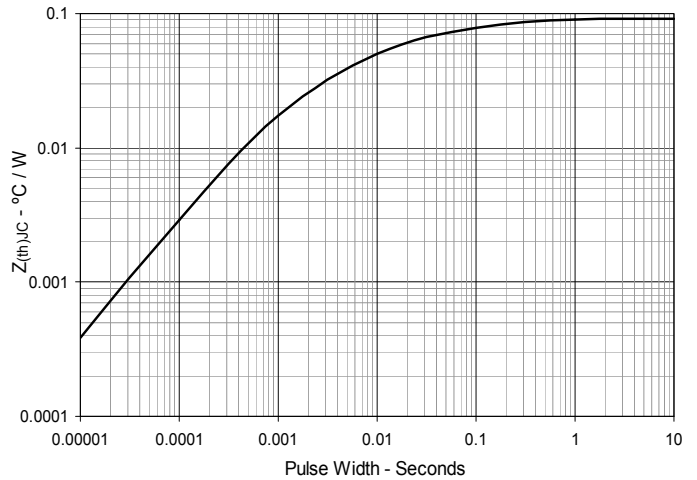

**Fig. 13. Inductive Switching Energy Loss vs. Gate Resistance**

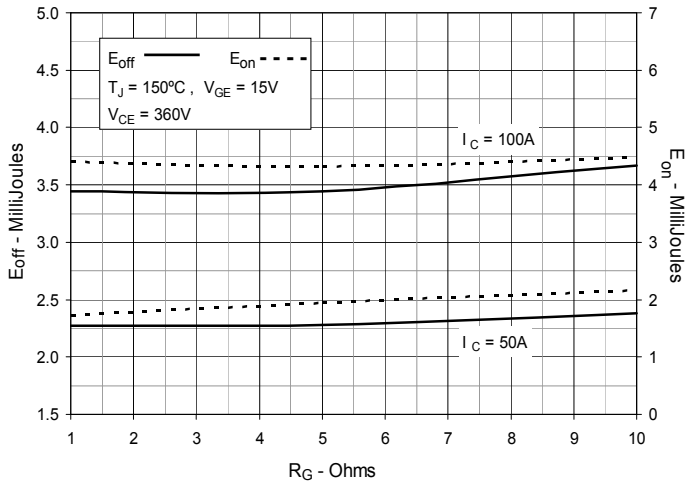

**Fig. 14. Inductive Switching Energy Loss vs. Collector Current**

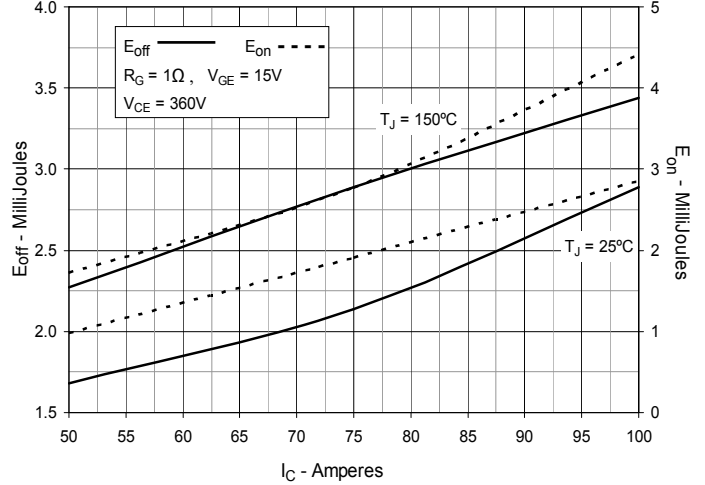

**Fig. 15. Inductive Switching Energy Loss vs. Junction Temperature**

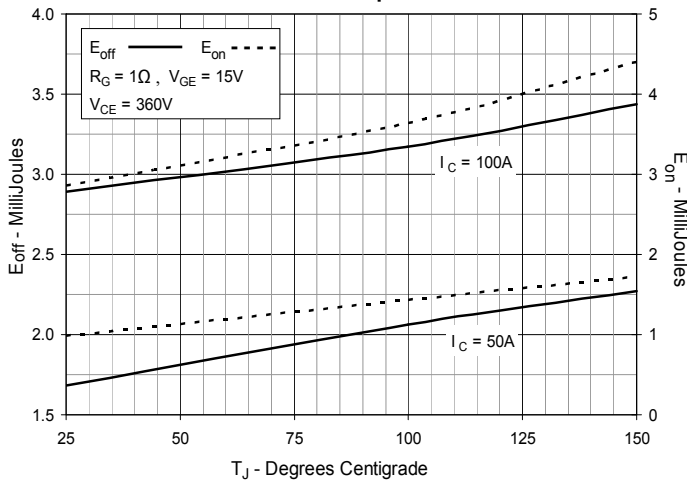

**Fig. 16. Inductive Turn-off Switching Times vs. Gate Resistance**

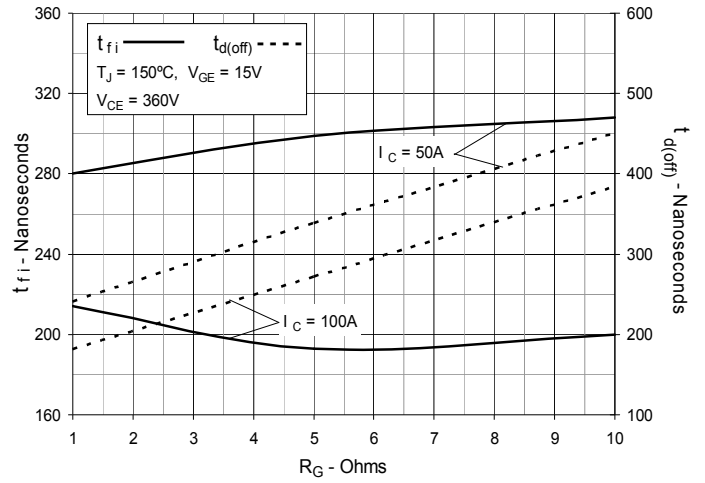

**Fig. 17. Inductive Turn-off Switching Times vs. Collector Current**

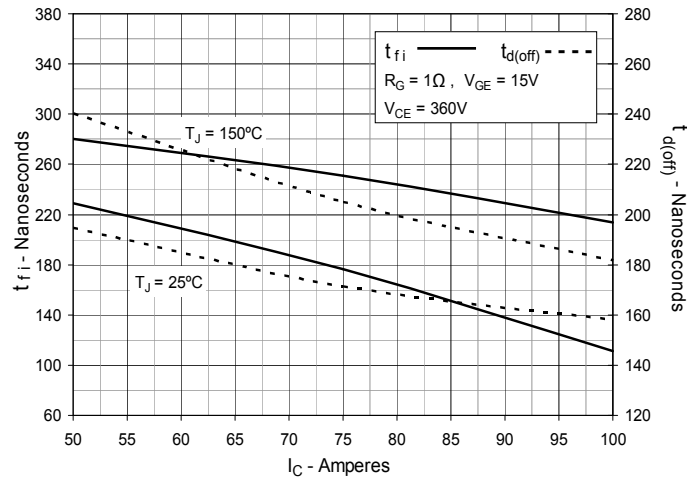

**Fig. 18. Inductive Turn-off Switching Times vs. Junction Temperature**

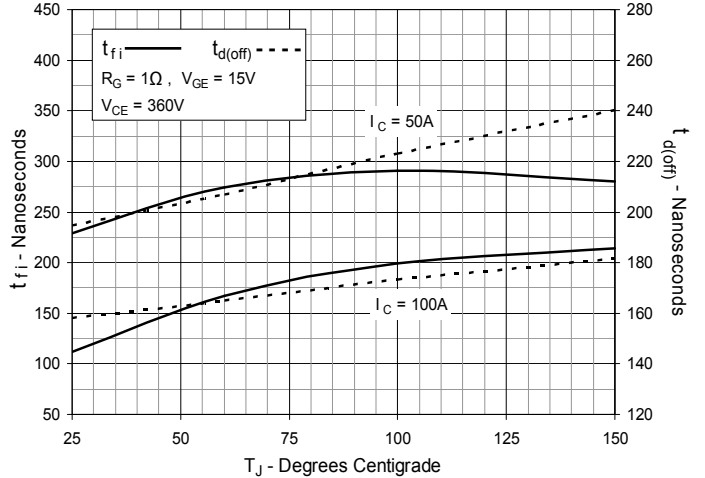

**Fig. 19. Inductive Turn-on Switching Times vs. Gate Resistance**

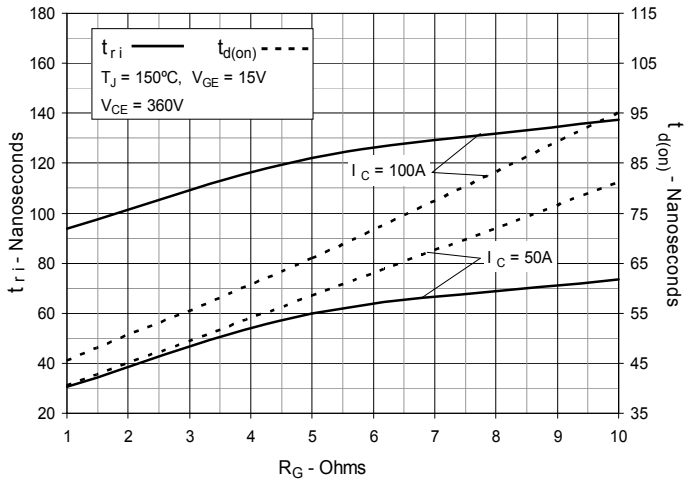

**Fig. 20. Inductive Turn-on Switching Times vs. Collector Current**

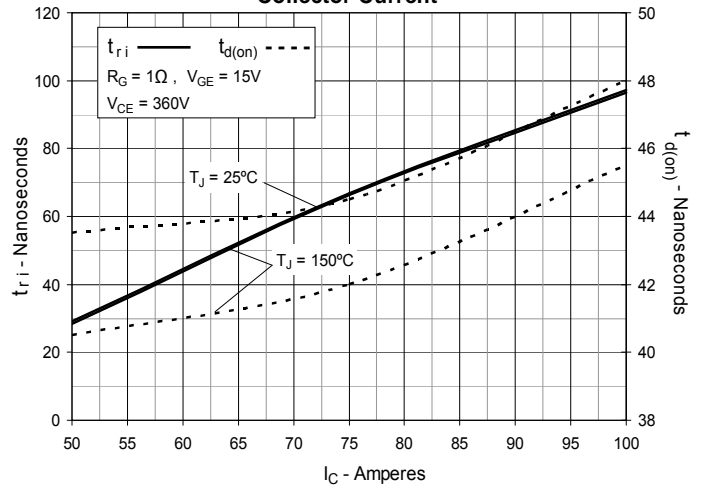

**Fig. 21. Inductive Turn-on Switching Times vs. Junction Temperature**

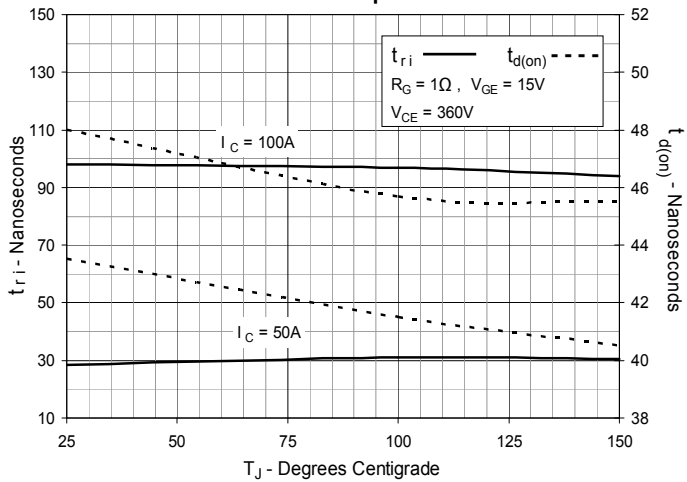



---

Disclaimer Notice - Information furnished is believed to be accurate and reliable. However, users should independently evaluate the suitability of and test each product selected for their own applications. Littelfuse products are not designed for, and may not be used in, all applications. Read complete Disclaimer Notice at [www.littelfuse.com/disclaimer-electronics](http://www.littelfuse.com/disclaimer-electronics).