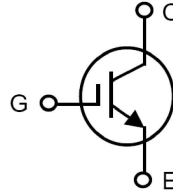


**1200V XPT™  
GenX4™ IGBT**

**IXYA20N120B4HV  
IXYP20N120B4**

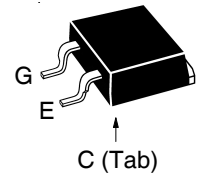
**V<sub>CES</sub> = 1200V**  
**I<sub>C110</sub> = 20A**  
**V<sub>CE(sat)</sub> ≤ 2.1V**  
**t<sub>fi(typ)</sub> = 90ns**

Extreme Light Punch Through  
IGBT for up to 5 - 30kHz Switching

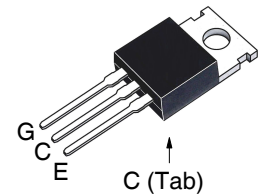


Symbol	Test Conditions	Maximum Ratings	
V <sub>CES</sub>	T <sub>J</sub> = 25°C to 175°C	1200	V
V <sub>CGR</sub>	T <sub>J</sub> = 25°C to 175°C, R <sub>GE</sub> = 1MΩ	1200	V
V <sub>GES</sub>	Continuous	±20	V
V <sub>GEM</sub>	Transient	±30	V
I <sub>C25</sub>	T <sub>C</sub> = 25°C	76	A
I <sub>C110</sub>	T <sub>C</sub> = 110°C	20	A
I <sub>CM</sub>	T <sub>C</sub> = 25°C, 1ms	130	A
<b>SSOA (RBSOA)</b>	V <sub>GE</sub> = 15V, T <sub>VJ</sub> = 150°C, R <sub>G</sub> = 10Ω Clamped Inductive Load	I <sub>CM</sub> = 40 V <sub>CE</sub> ≤ 0.8 • V <sub>CES</sub>	A
P <sub>C</sub>	T <sub>C</sub> = 25°C	375	W
T <sub>J</sub>		-55 ... +175	°C
T <sub>JM</sub>		175	°C
T <sub>stg</sub>		-55 ... +175	°C
T <sub>L</sub>	Maximum Lead Temperature for Soldering	300	°C
T <sub>SOLD</sub>	1.6 mm (0.062in.) from Case for 10s	260	°C
M <sub>d</sub>	Mounting Torque (TO-220)	1.13/10	Nm/lb.in
F <sub>C</sub>	Mounting Force (TO-263HV)	10..65 / 22..14.6	N/lb
<b>Weight</b>	TO-263HV	2.5	g
	TO-220	3.0	g

**TO-263HV  
(IXYA..HV)**



**TO-220  
(IXYP)**



G = Gate      D = Collector  
E = Emitter    Tab = Collector

**Features**

- Optimized for 5-30kHz Switching
- Positive Thermal Coefficient of V<sub>ce(sat)</sub>
- International Standard Packages

**Advantages**

- High Power Density
- Low Gate Drive Requirement

**Applications**

- Power Inverters
- UPS
- Motor Drives
- SMPS
- Battery Chargers
- Welding Machines
- Lamp Ballasts

Symbol	Test Conditions (T <sub>J</sub> = 25°C, Unless Otherwise Specified)	Characteristic Values		
		Min.	Typ.	Max.
<b>BV<sub>CES</sub></b>	I <sub>C</sub> = 250μA, V <sub>GE</sub> = 0V	1200		V
<b>V<sub>GE(th)</sub></b>	I <sub>C</sub> = 250μA, V <sub>CE</sub> = V <sub>GE</sub>	4.0		6.5 V
<b>I<sub>CES</sub></b>	V <sub>CE</sub> = V <sub>CES</sub> , V <sub>GE</sub> = 0V T <sub>J</sub> = 150°C			25 μA 5 mA
<b>I<sub>GES</sub></b>	V <sub>CE</sub> = 0V, V <sub>GE</sub> = ±20V			±100 nA
<b>V<sub>CE(sat)</sub></b>	I <sub>C</sub> = 20A, V <sub>GE</sub> = 15V, Note 1 T <sub>J</sub> = 150°C	1.83 2.18		2.10 V V

Symbol Test Conditions ( $T_J = 25^\circ\text{C}$ Unless Otherwise Specified)		Characteristic Values		
		Min.	Typ.	Max.
$g_{fs}$	$I_C = 20\text{A}, V_{CE} = 10\text{V}$ , Note 1	7.5	12.5	S
$C_{ies}$	} $V_{CE} = 25\text{V}, V_{GE} = 0\text{V}, f = 1\text{MHz}$		890	pF
$C_{oes}$			58	pF
$C_{res}$			33	pF
$Q_{g(on)}$	} $I_C = 20\text{A}, V_{GE} = 15\text{V}, V_{CE} = 0.5 \cdot V_{CES}$		44	nC
$Q_{ge}$			8	nC
$Q_{gc}$			20	nC
$t_{d(on)}$	} <b>Inductive load, <math>T_J = 25^\circ\text{C}</math></b> $I_C = 20\text{A}, V_{GE} = 15\text{V}$ $V_{CE} = 0.8 \cdot V_{CES}, R_G = 10\Omega$ Note 2		15	ns
$t_{ri}$			47	ns
$E_{on}$			3.9	mJ
$t_{d(off)}$			200	ns
$t_{fi}$			90	ns
$E_{off}$			1.6	mJ
$t_{d(on)}$	} <b>Inductive load, <math>T_J = 125^\circ\text{C}</math></b> $I_C = 20\text{A}, V_{GE} = 15\text{V}$ $V_{CE} = 0.8 \cdot V_{CES}, R_G = 10\Omega$ Note 2		13	ns
$t_{ri}$			35	ns
$E_{on}$			4.6	mJ
$t_{d(off)}$			270	ns
$t_{fi}$			170	ns
$E_{off}$			2.7	mJ
$R_{thJC}$	TO-220			0.40 $^\circ\text{C/W}$
$R_{thCS}$		0.50		$^\circ\text{C/W}$

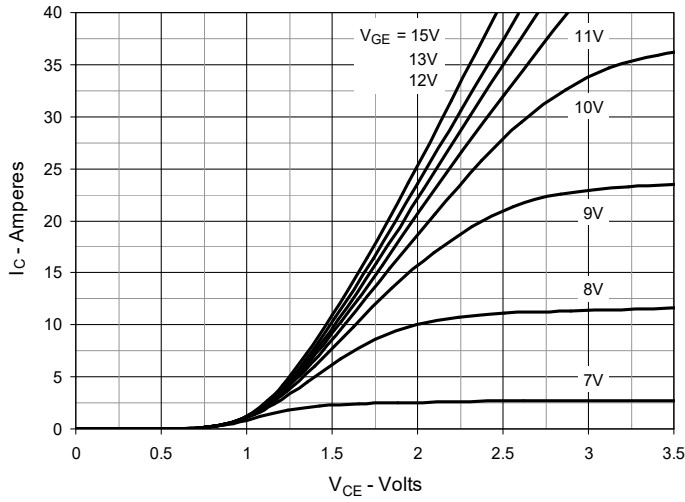
**Notes:**

1. Pulse test,  $t \leq 300\mu\text{s}$ , duty cycle,  $d \leq 2\%$ .
2. Switching times & energy losses may increase for higher  $V_{CE}$  (clamp),  $T_J$  or  $R_G$ .

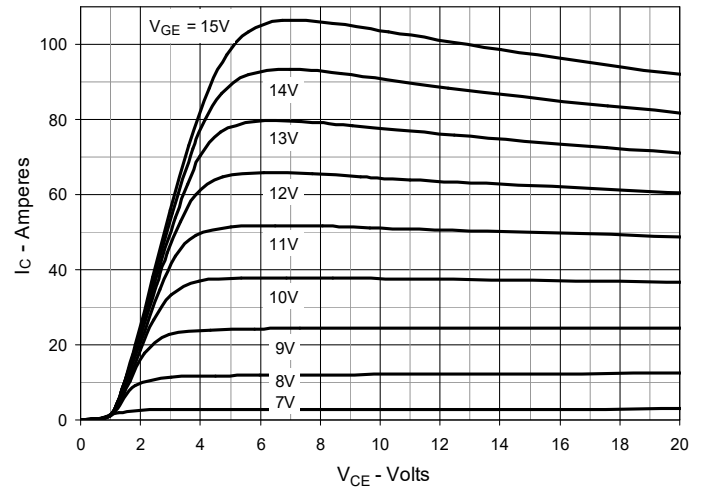
IXYS Reserves the Right to Change Limits, Test Conditions, and Dimensions.

IXYS MOSFETs and IGBTs are covered	4,835,592	4,931,844	5,049,961	5,237,481	6,162,665	6,404,065 B1	6,683,344	6,727,585	7,005,734 B2	7,157,338B2
by one or more of the following U.S. patents:	4,860,072	5,017,508	5,063,307	5,381,025	6,259,123 B1	6,534,343	6,710,405 B2	6,759,692	7,063,975 B2	
	4,881,106	5,034,796	5,187,117	5,486,715	6,306,728 B1	6,583,505	6,710,463	6,771,478 B2	7,071,537	

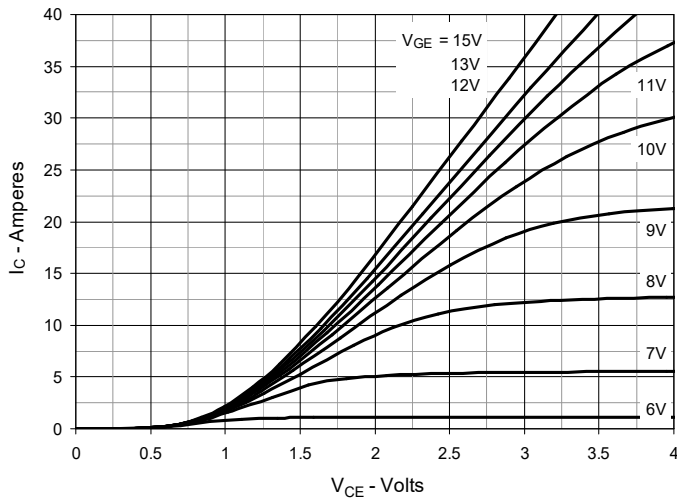
**Fig. 1. Output Characteristics @  $T_J = 25^\circ\text{C}$**



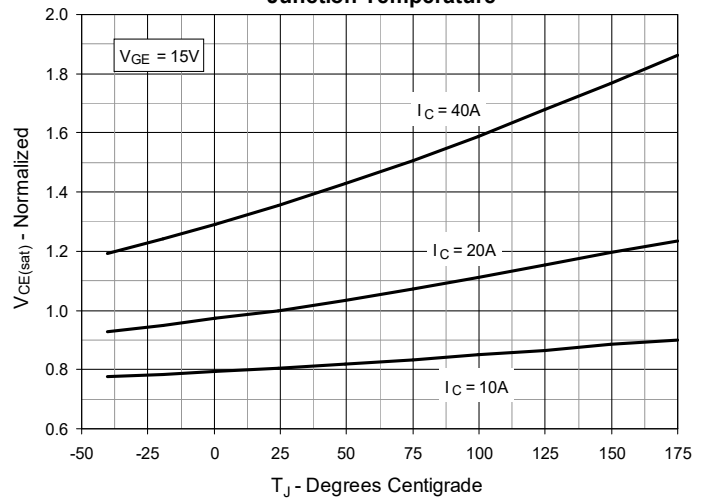
**Fig. 2. Extended Output Characteristics @  $T_J = 25^\circ\text{C}$**



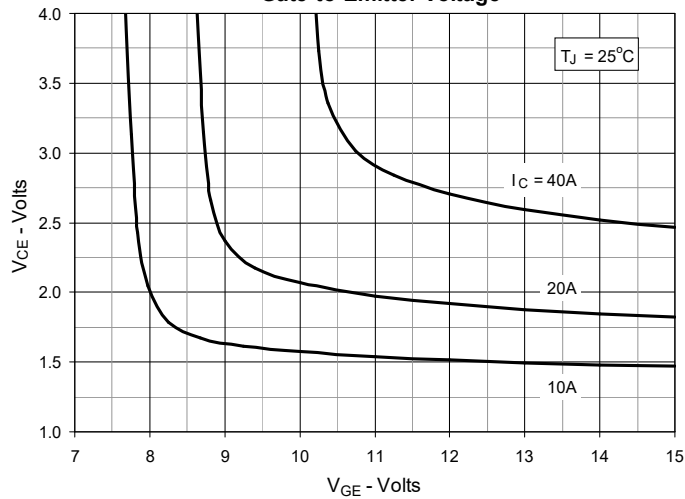
**Fig. 3. Output Characteristics @  $T_J = 150^\circ\text{C}$**



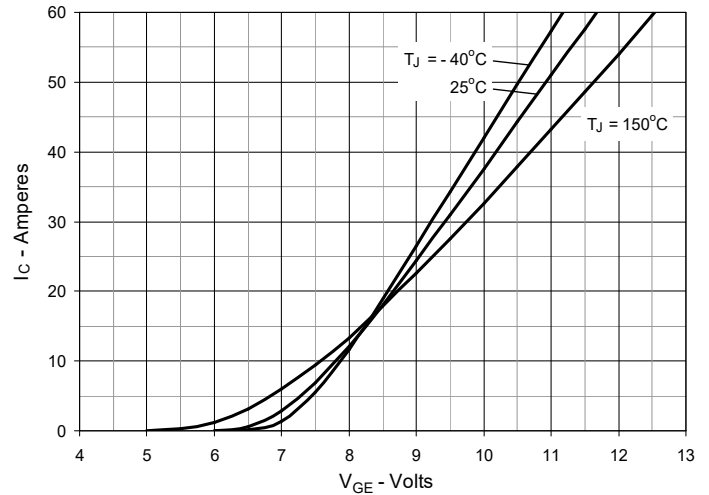
**Fig. 4. Dependence of  $V_{CE(sat)}$  on Junction Temperature**



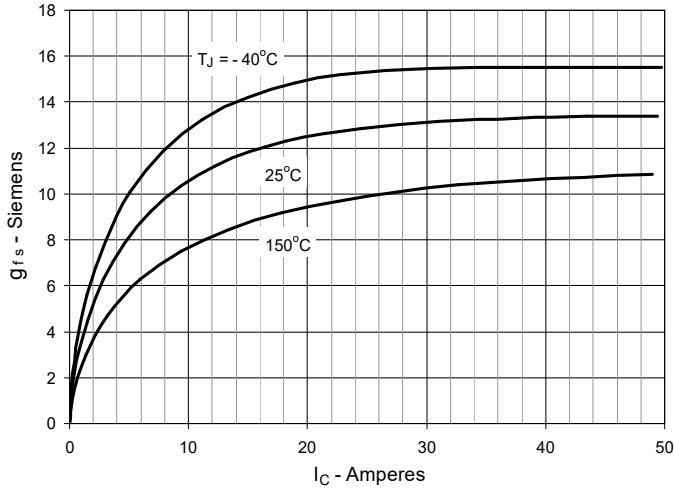
**Fig. 5. Collector-to-Emitter Voltage vs. Gate-to-Emitter Voltage**



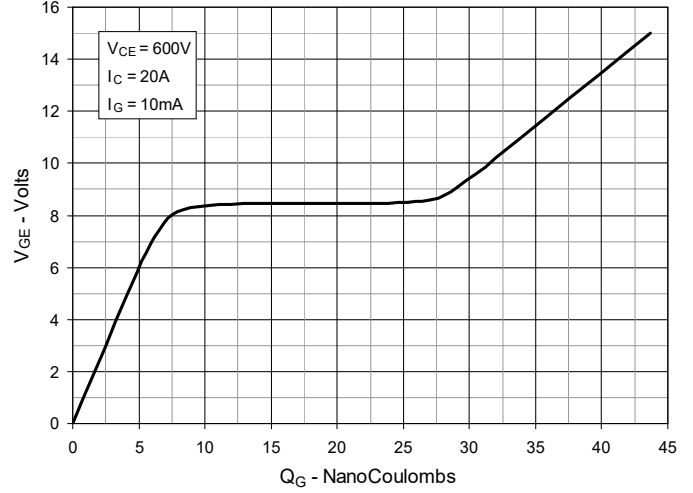
**Fig. 6. Input Admittance**



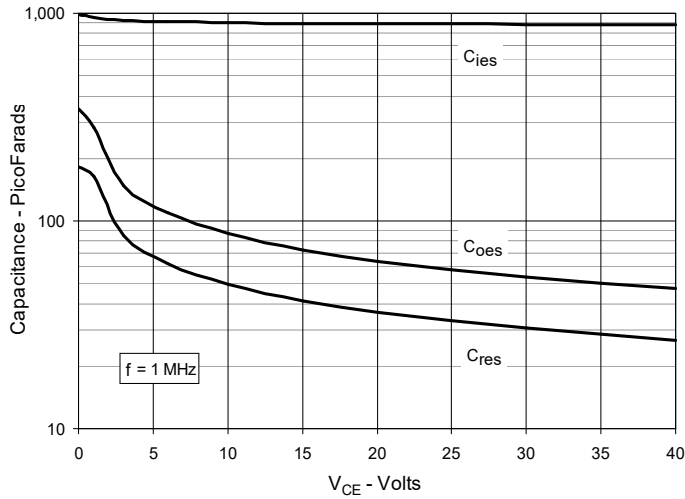
**Fig. 7. Transconductance**



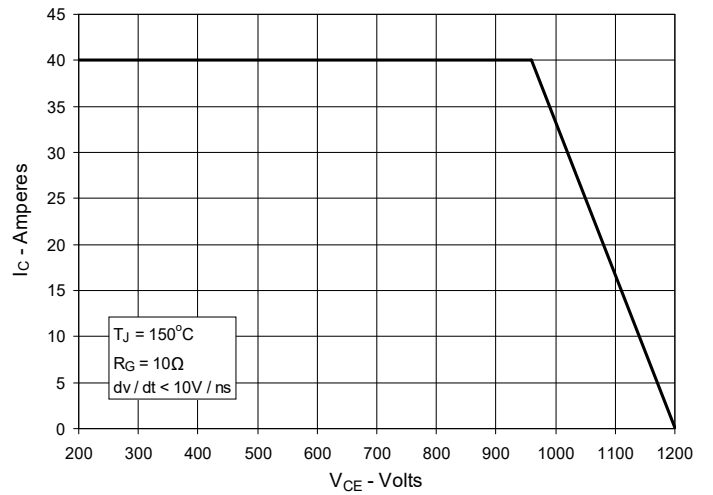
**Fig. 8. Gate Charge**



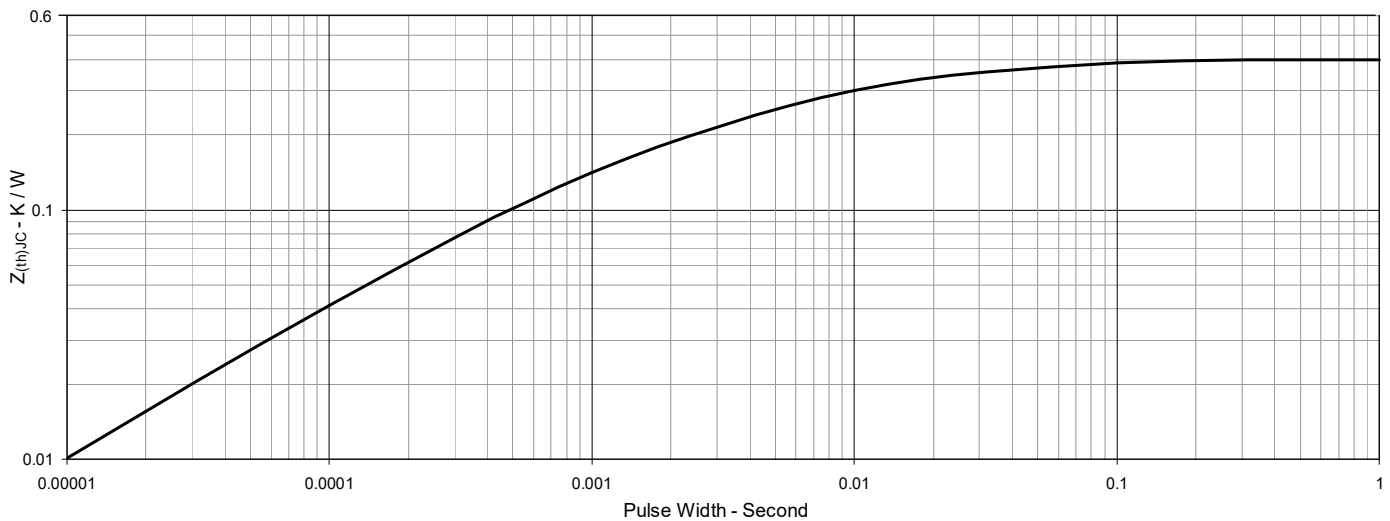
**Fig. 9. Capacitance**



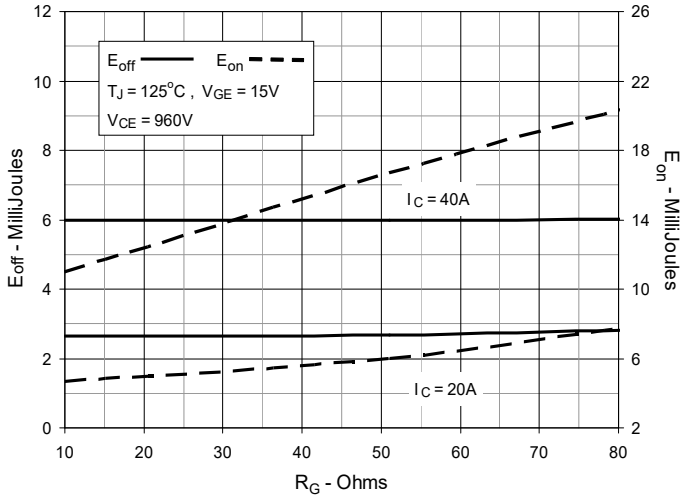
**Fig. 10. Reverse-Bias Safe Operating Area**



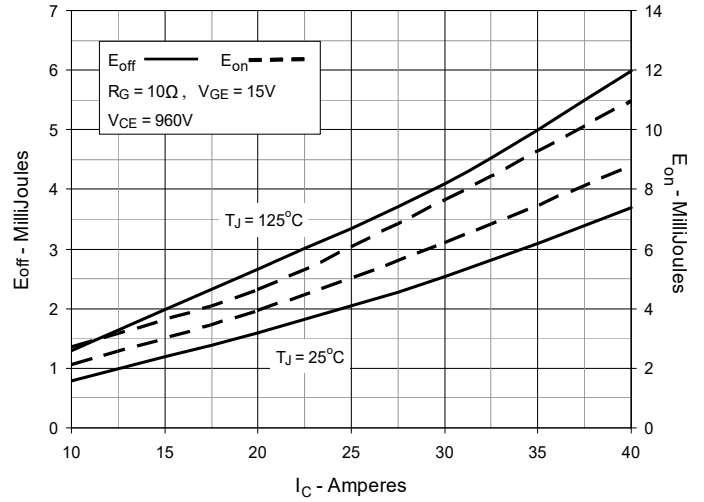
**Fig. 11. Maximum Transient Thermal Impedance**



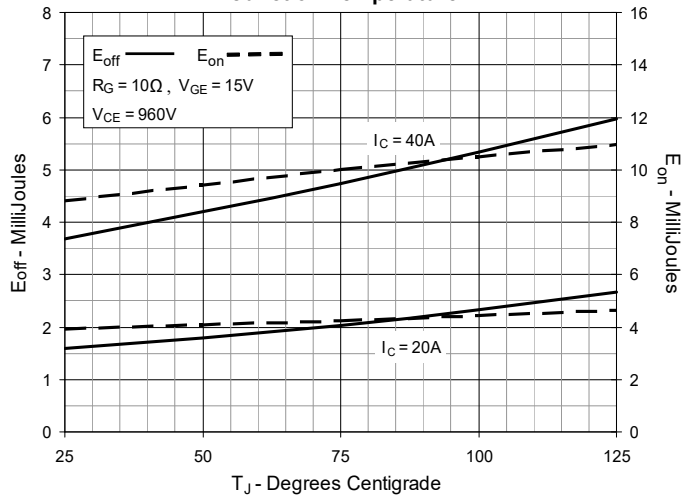
**Fig. 12. Inductive Switching Energy Loss vs. Gate Resistance**



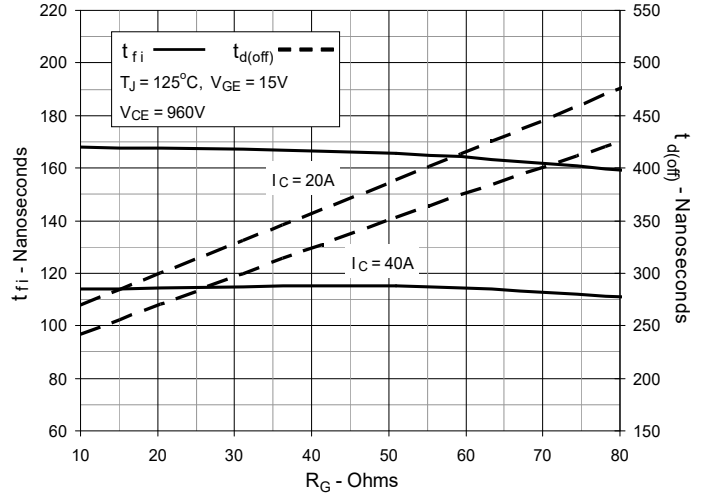
**Fig. 13. Inductive Switching Energy Loss vs. Collector Current**



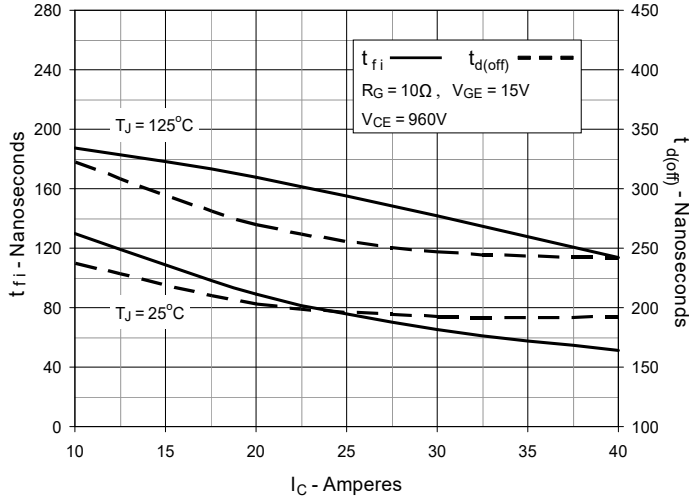
**Fig. 14. Inductive Switching Energy Loss vs. Junction Temperature**



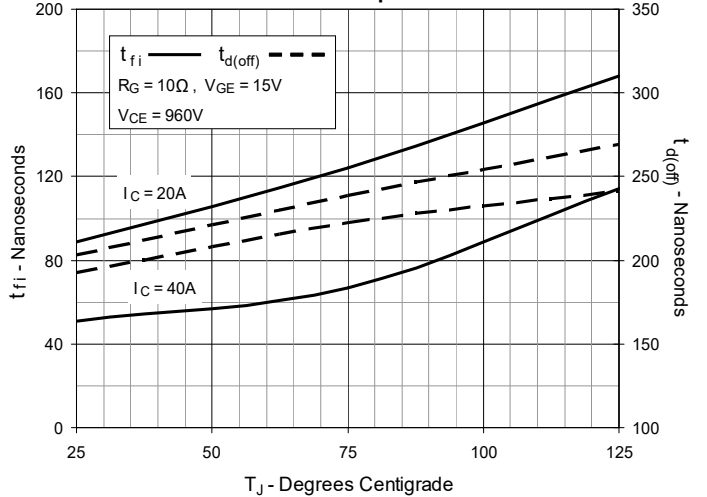
**Fig. 15. Inductive Turn-off Switching Times vs. Gate Resistance**



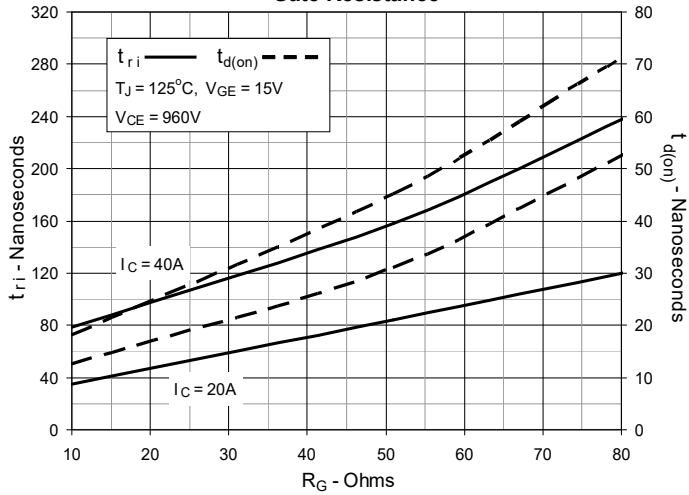
**Fig. 16. Inductive Turn-off Switching Times vs. Collector Current**



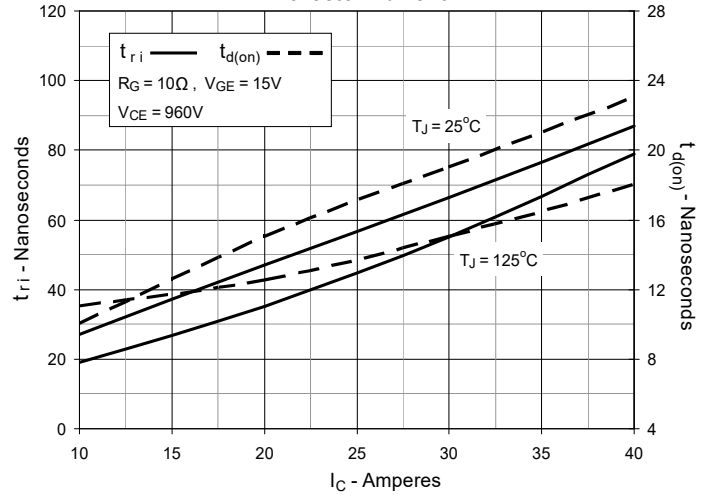
**Fig. 17. Inductive Turn-off Switching Times vs. Junction Temperature**



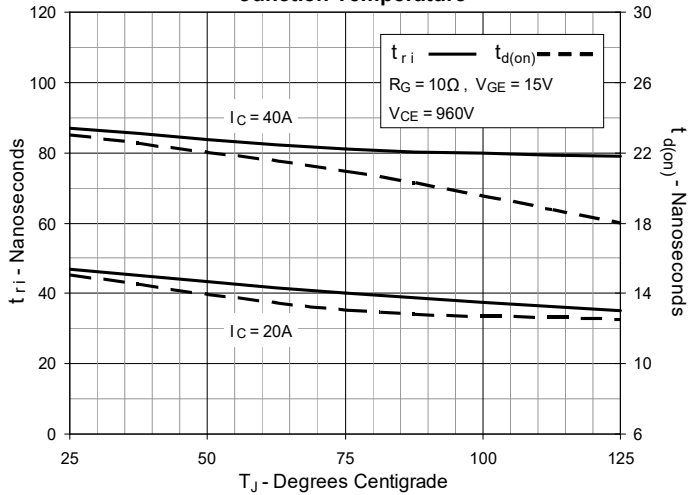
**Fig. 18. Inductive Turn-on Switching Times vs. Gate Resistance**

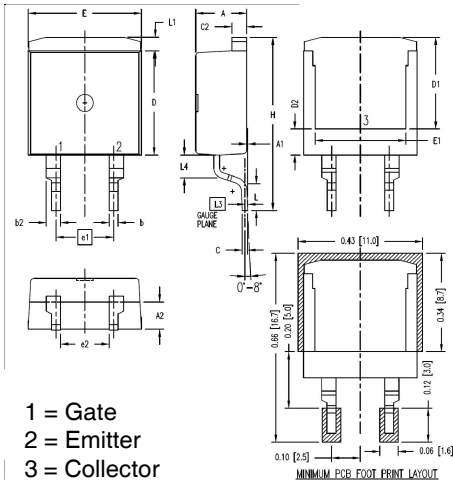


**Fig. 19. Inductive Turn-on Switching Times vs. Collector Current**

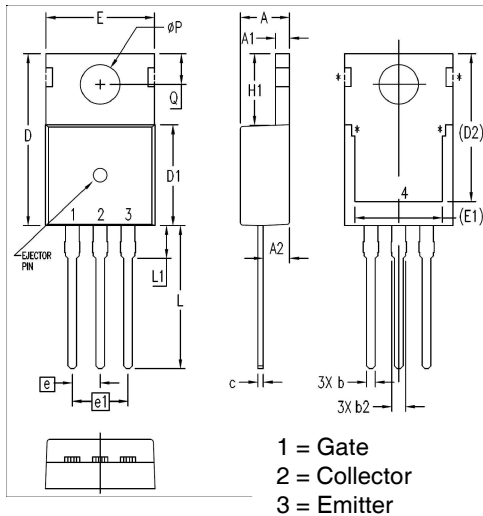


**Fig. 20. Inductive Turn-on Switching Times vs. Junction Temperature**



**TO-263HV Outline**


SYM	INCHES		MILLIMETER	
	MIN	MAX	MIN	MAX
A	.170	.185	4.30	4.70
A1	.000	.008	0.00	0.20
A2	.091	.098	2.30	2.50
b	.028	.035	0.70	0.90
b2	.046	.054	1.18	1.38
C	.018	.024	0.45	0.60
C2	.049	.055	1.25	1.40
D	.354	.370	9.00	9.40
D1	.311	.327	7.90	8.30
D2	.083	.098	2.10	2.50
E	.386	.402	9.80	10.20
E1	.307	.323	7.80	8.20
e1	.200 BSC		5.08 BSC	
(e2)	.163	.174	4.13	4.43
H	.591	.614	15.00	15.60
L	.079	.102	2.00	2.60
L1	.039	.055	1.00	1.40
L3	.010 BSC		0.254 BSC	
(L4)	.071	.087	1.80	2.20

**TO-220 Outline**


SYM	INCHES		MILLIMETERS	
	MIN	MAX	MIN	MAX
A	.169	.185	4.30	4.70
A1	.047	.055	1.20	1.40
A2	.079	.106	2.00	2.70
b	.024	.039	0.60	1.00
b2	.045	.057	1.15	1.45
c	.014	.026	0.35	0.65
D	.587	.626	14.90	15.90
D1	.335	.370	8.50	9.40
(D2)	.500	.531	12.70	13.50
E	.382	.406	9.70	10.30
(E1)	.283	.323	7.20	8.20
e	.100 BSC		2.54 BSC	
e1	.200 BSC		5.08 BSC	
H1	.244	.268	6.20	6.80
L	.492	.547	12.50	13.90
L1	.110	.154	2.80	3.90
ØP	.134	.150	3.40	3.80
Q	.106	.126	2.70	3.20



---

Disclaimer Notice - Information furnished is believed to be accurate and reliable. However, users should independently evaluate the suitability of and test each product selected for their own applications. Littelfuse products are not designed for, and may not be used in, all applications. Read complete Disclaimer Notice at [www.littelfuse.com/disclaimer-electronics](http://www.littelfuse.com/disclaimer-electronics).

IXYS Reserves the Right to Change Limits, Test Conditions, and Dimensions.

---