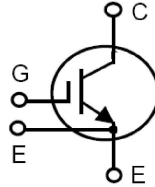


# 1200V XPT™ IGBT GenX4™

## IXYN140N120A4

Ultra Low-Vsat IGBT for  
up to 5kHz Switching



$$V_{CES} = 1200V$$

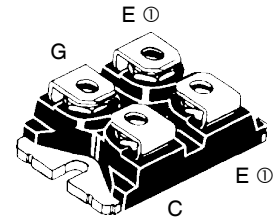
$$I_{C110} = 140A$$

$$V_{CE(sat)} \leq 1.70V$$

$$t_{fi(typ)} = 320ns$$

SOT-227B, miniBLOC

E153432



G = Gate, C = Collector, E = Emitter  
Ⓢ either emitter terminal can be used as  
Main or Kelvin Emitter

Symbol	Test Conditions	Maximum Ratings	
$V_{CES}$	$T_J = 25^\circ C$ to $175^\circ C$	1200	V
$V_{CGR}$	$T_J = 25^\circ C$ to $175^\circ C$ , $R_{GE} = 1M\Omega$	1200	V
$V_{GES}$	Continuous	$\pm 20$	V
$V_{GEM}$	Transient	$\pm 30$	V
$I_{C25}$	$T_C = 25^\circ C$ (Chip Capability)	380	A
$I_{LRMS}$	Terminal Current Limit	200	A
$I_{C110}$	$T_C = 110^\circ C$	140	A
$I_{CM}$	$T_C = 25^\circ C$ , 1ms	1200	A
<b>SSOA</b> <b>(RBSOA)</b>	$V_{GE} = 15V$ , $T_{VJ} = 125^\circ C$ , $R_G = 2\Omega$ Clamped Inductive Load	$I_{CM} = 280$ $0.8 \cdot V_{CES}$	A V
$P_C$	$T_C = 25^\circ C$	1070	W
$T_J$		-55 ... +175	$^\circ C$
$T_{JM}$		175	$^\circ C$
$T_{stg}$		-55 ... +175	$^\circ C$
$V_{ISOL}$	50/60Hz $I_{ISOL} \leq 1mA$	t = 1min t = 1s	2500 V~ 3000 V~
$M_d$	Mounting Torque Terminal Connection Torque	1.5/13 1.3/11.5	Nm/lb.in Nm/lb.in
<b>Weight</b>		30	g

### Features

- miniBLOC, with Aluminium Nitride Isolation
- International Standard Package
- Isolation Voltage 2500V~
- Optimized for Low Conduction Losses
- Positive Thermal Coefficient of  $V_{ce(sat)}$
- High Current Handling Capability

### Advantages

- High Power Density
- Low Gate Drive Requirement

### Applications

- Power Inverters
- UPS
- Motor Drives
- SMPS
- PFC Circuits
- Battery Chargers
- Welding Machines
- Lamp Ballasts
- Inrush Current Protection Circuits

Symbol	Test Conditions ( $T_J = 25^\circ C$ , Unless Otherwise Specified)	Characteristic Values		
		Min.	Typ.	Max.
$BV_{CES}$	$I_C = 250\mu A$ , $V_{GE} = 0V$	1200		V
$V_{GE(th)}$	$I_C = 4mA$ , $V_{CE} = V_{GE}$	4.5		6.5 V
$I_{CES}$	$V_{CE} = V_{CES}$ , $V_{GE} = 0V$ $T_J = 125^\circ C$			25 $\mu A$ 5 mA
$I_{GES}$	$V_{CE} = 0V$ , $V_{GE} = \pm 20V$			$\pm 200$ nA
$V_{CE(sat)}$	$I_C = I_{C110}$ , $V_{GE} = 15V$ , Note 1 $T_J = 150^\circ C$		1.34 1.50	1.70 V V

Symbol Test Conditions ( $T_J = 25^\circ\text{C}$ Unless Otherwise Specified)		Characteristic Values		
		Min.	Typ.	Max.
$g_{fs}$	$I_C = 60\text{A}, V_{CE} = 10\text{V}, \text{Note 1}$	60	100	S
$C_{ies}$	$V_{CE} = 25\text{V}, V_{GE} = 0\text{V}, f = 1\text{MHz}$		8300	pF
$C_{oes}$			470	pF
$C_{res}$			300	pF
$Q_{g(on)}$	$I_C = I_{C110}, V_{GE} = 15\text{V}, V_{CE} = 0.5 \cdot V_{CES}$		420	nC
$Q_{ge}$			68	nC
$Q_{gc}$			210	nC
$t_{d(on)}$	<b>Inductive load, <math>T_J = 25^\circ\text{C}</math></b> $I_C = 70\text{A}, V_{GE} = 15\text{V}$ $V_{CE} = 0.5 \cdot V_{CES}, R_G = 1.5\Omega$ Note 2		52	ns
$t_{ri}$			47	ns
$E_{on}$			4.9	mJ
$t_{d(off)}$			590	ns
$t_{fi}$			320	ns
$E_{off}$			12.0	mJ
$t_{d(on)}$	<b>Inductive load, <math>T_J = 150^\circ\text{C}</math></b> $I_C = 70\text{A}, V_{GE} = 15\text{V}$ $V_{CE} = 0.5 \cdot V_{CES}, R_G = 1.5\Omega$ Note 2		44	ns
$t_{ri}$			42	ns
$E_{on}$			7.4	mJ
$t_{d(off)}$			710	ns
$t_{fi}$			530	ns
$E_{off}$			20.0	mJ
$R_{thJC}$				0.14 °C/W
$R_{thCS}$		0.05		°C/W

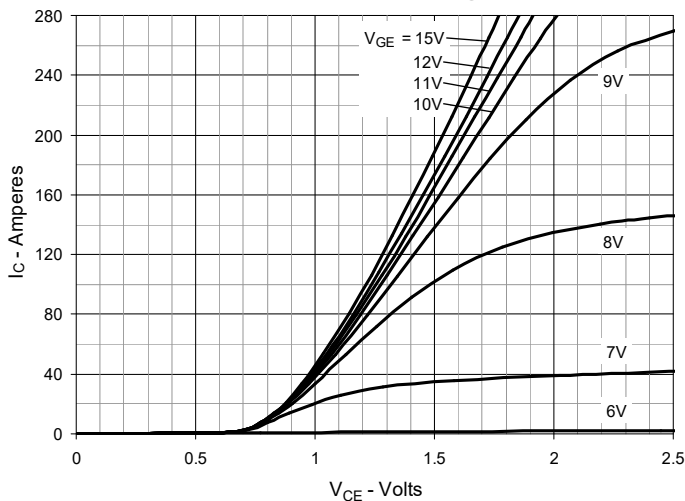
**Notes:**

1. Pulse test,  $t \leq 300\mu\text{s}$ , duty cycle,  $d \leq 2\%$ .
2. Switching times & energy losses may increase for higher  $V_{CE}$  (clamp),  $T_J$  or  $R_G$ .

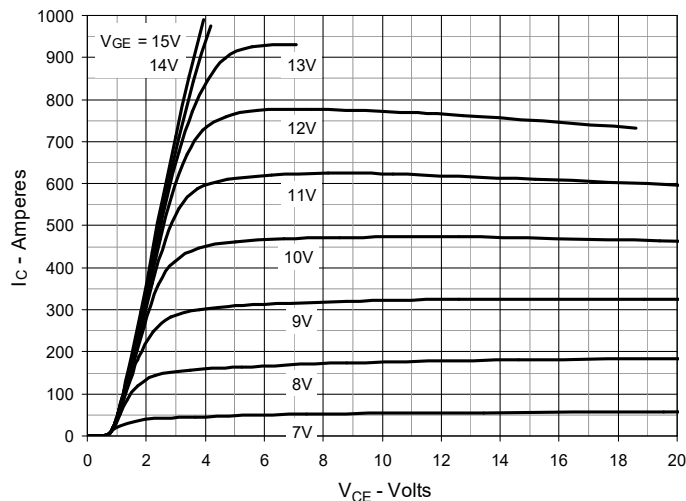
Littelfuse reserves the right to change limits, test conditions and dimensions.

IXYS MOSFETs and IGBTs are covered	4,835,592	4,931,844	5,049,961	5,237,481	6,162,665	6,404,065 B1	6,683,344	6,727,585	7,005,734 B2	7,157,338B2
by one or more of the following U.S. patents:	4,860,072	5,017,508	5,063,307	5,381,025	6,259,123 B1	6,534,343	6,710,405 B2	6,759,692	7,063,975 B2	
	4,881,106	5,034,796	5,187,117	5,486,715	6,306,728 B1	6,583,505	6,710,463	6,771,478 B2	7,071,537	

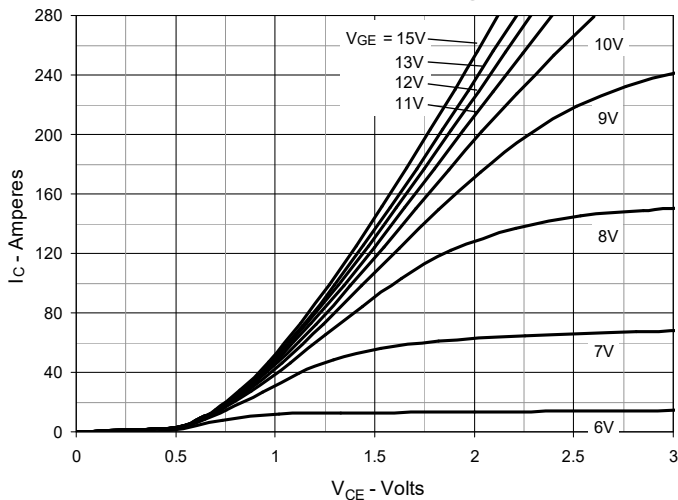
**Fig. 1. Output Characteristics @  $T_J = 25^\circ\text{C}$**



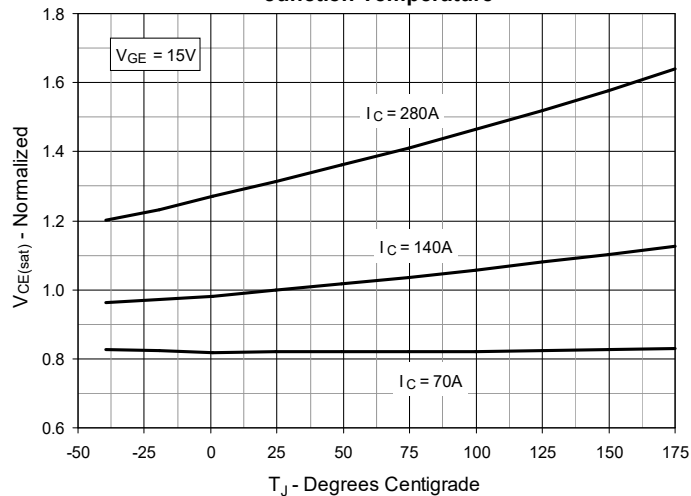
**Fig. 2. Extended Output Characteristics @  $T_J = 25^\circ\text{C}$**



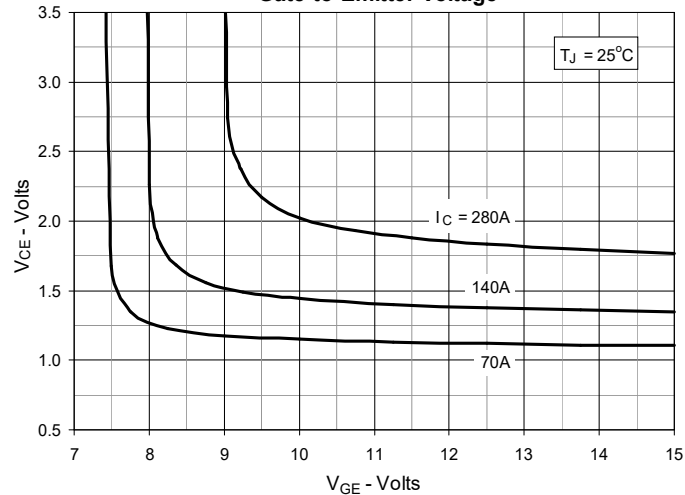
**Fig. 3. Output Characteristics @  $T_J = 150^\circ\text{C}$**



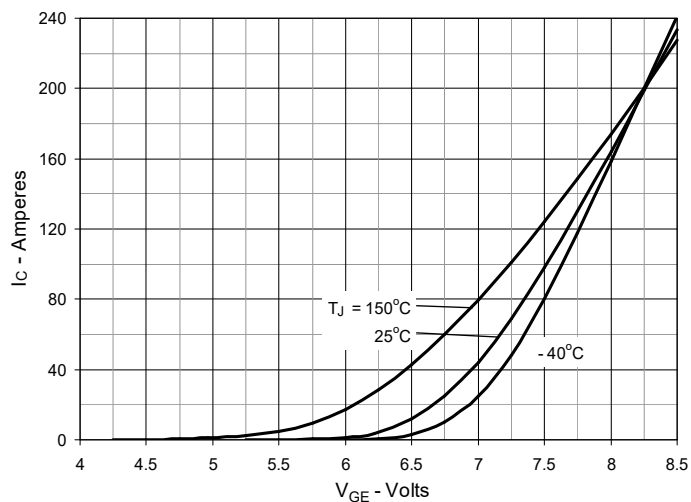
**Fig. 4. Dependence of  $V_{CE(sat)}$  on Junction Temperature**

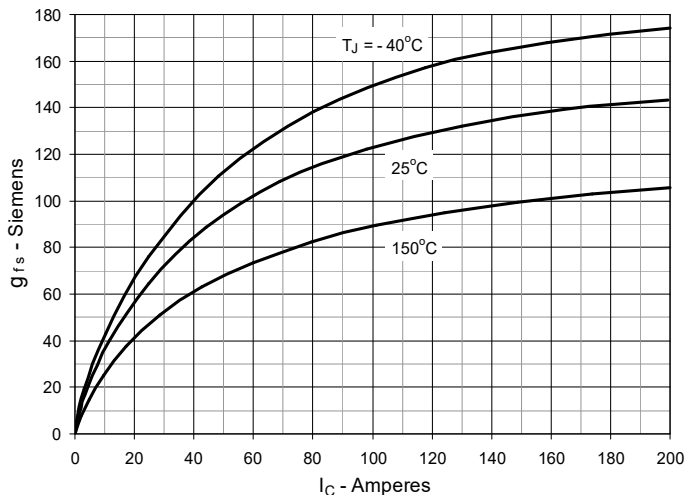
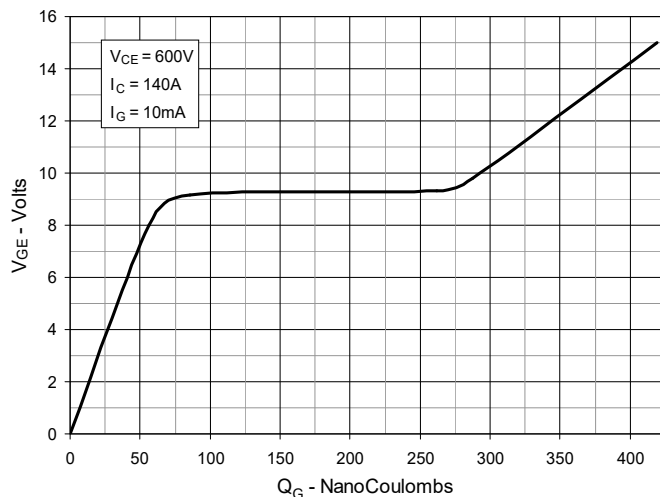
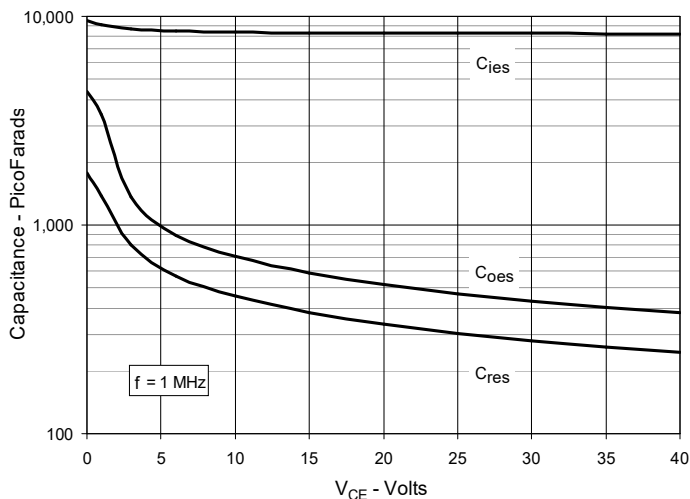
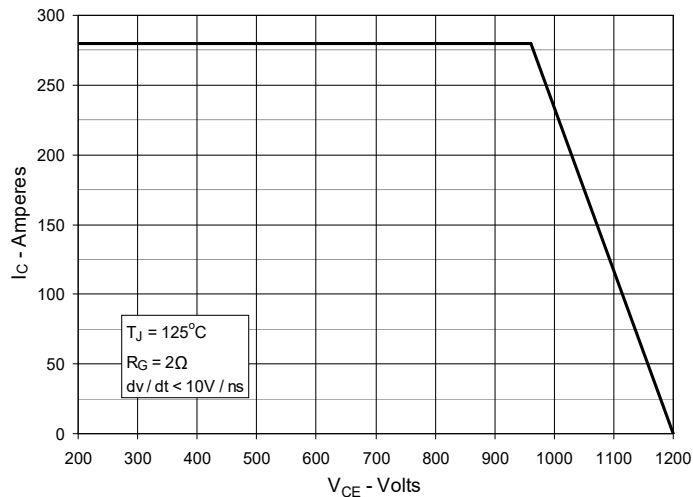
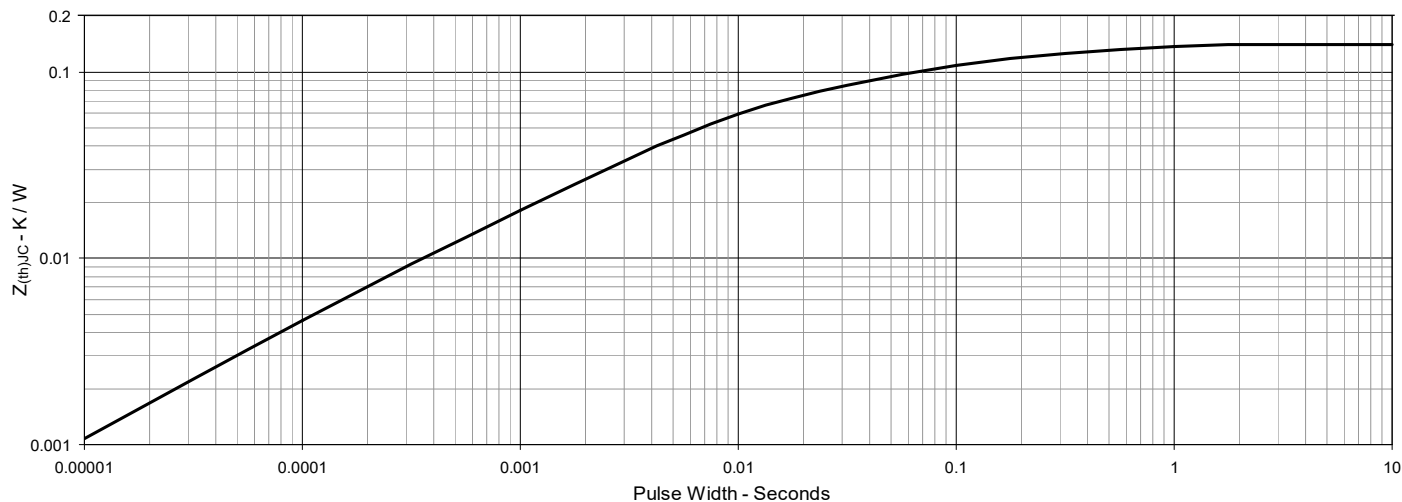


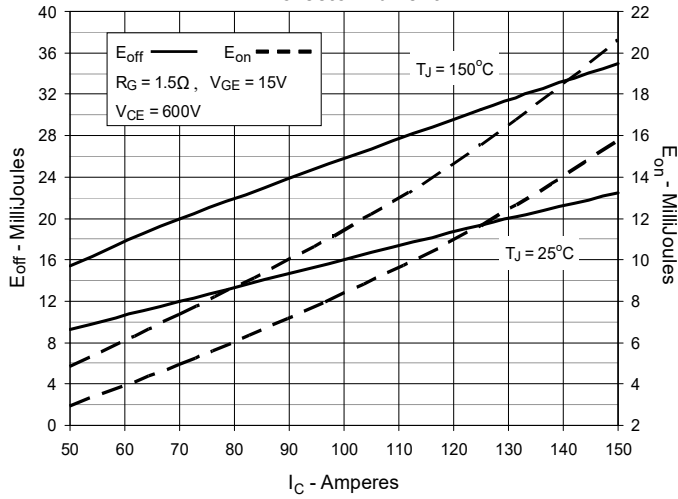
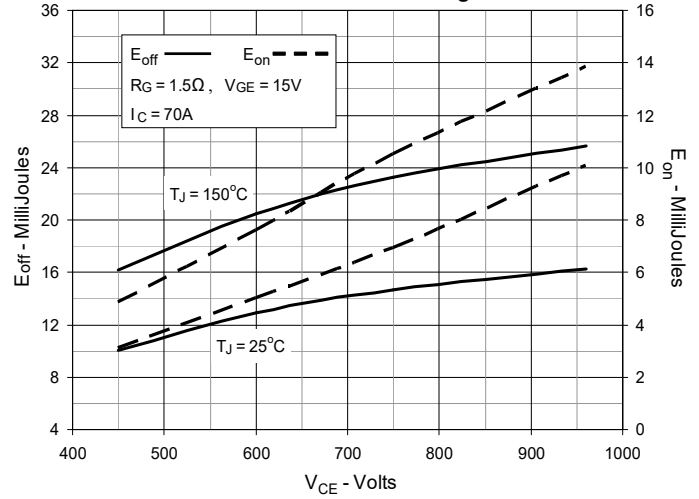
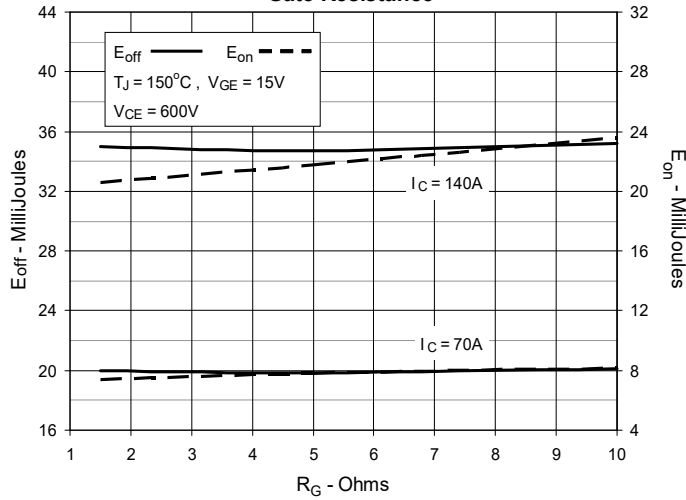
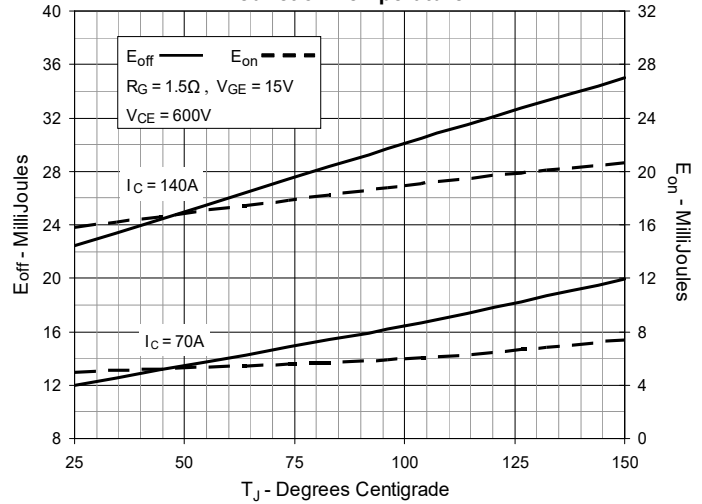
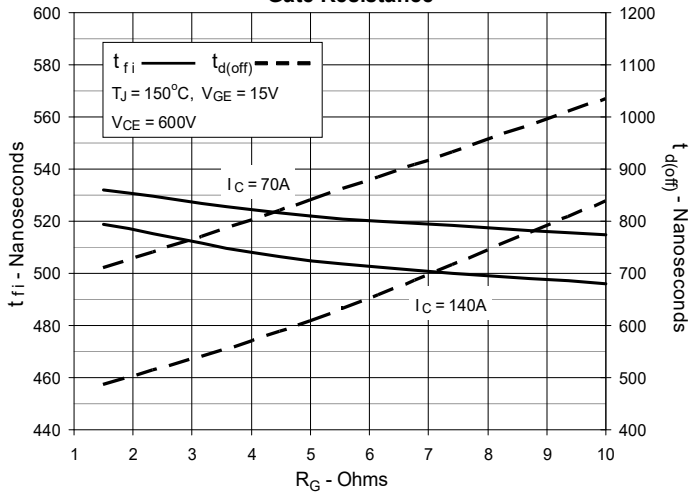
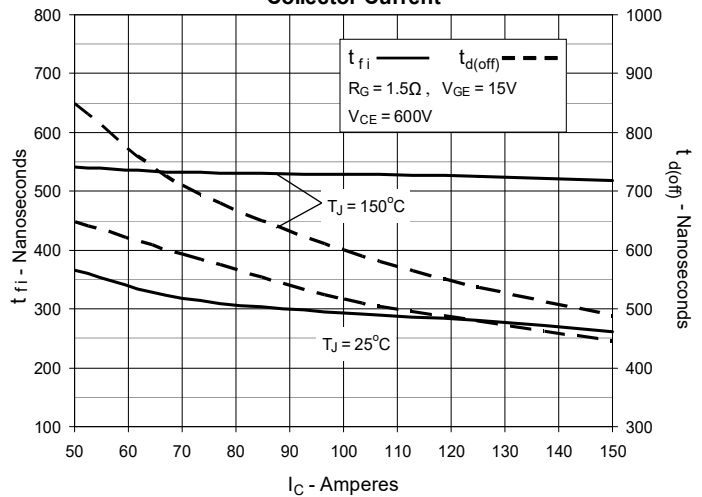
**Fig. 5. Collector-to-Emitter Voltage vs. Gate-to-Emitter Voltage**



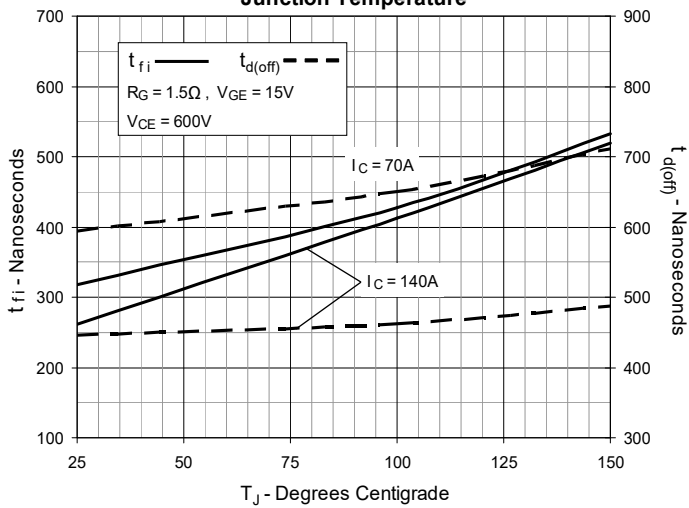
**Fig. 6. Input Admittance**



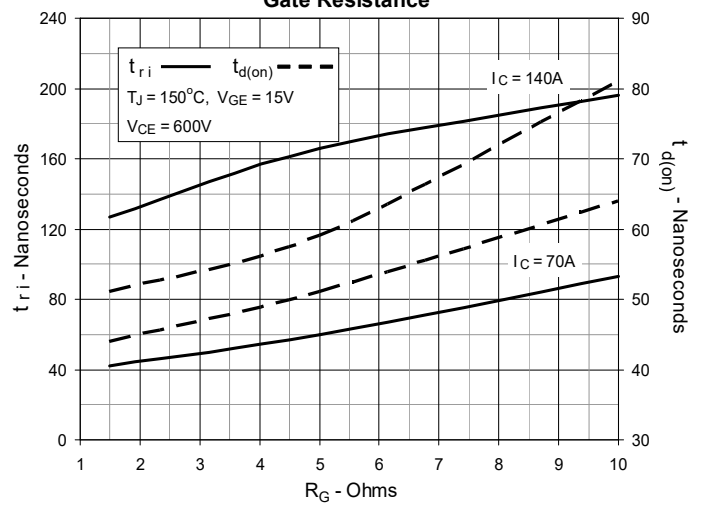
**Fig. 7. Transconductance**

**Fig. 8. Gate Charge**

**Fig. 9. Capacitance**

**Fig. 10. Reverse-Bias Safe Operating Area**

**Fig. 11. Maximum Transient Thermal Impedance**


**Fig. 12. Inductive Switching Energy Loss vs. Collector Current**

**Fig. 13. Inductive Switching Energy Loss vs. Collector-Emitter Voltage**

**Fig. 14. Inductive Switching Energy Loss vs. Gate Resistance**

**Fig. 15. Inductive Switching Energy Loss vs. Junction Temperature**

**Fig. 16. Inductive Turn-off Switching Times vs. Gate Resistance**

**Fig. 17. Inductive Turn-off Switching Times vs. Collector Current**


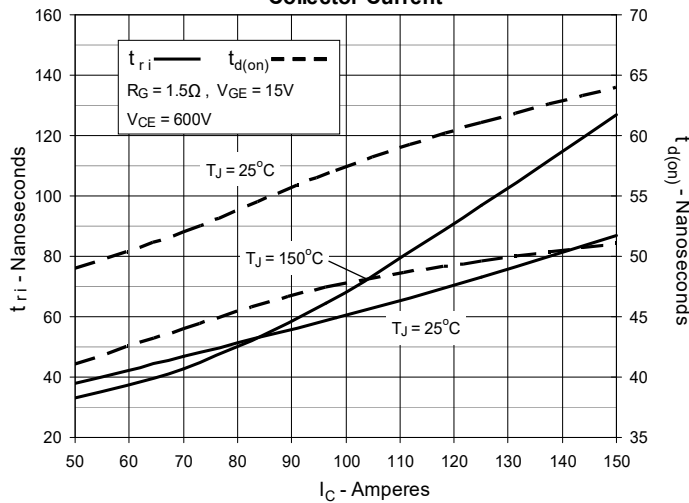
**Fig. 18. Inductive Turn-off Switching Times vs. Junction Temperature**



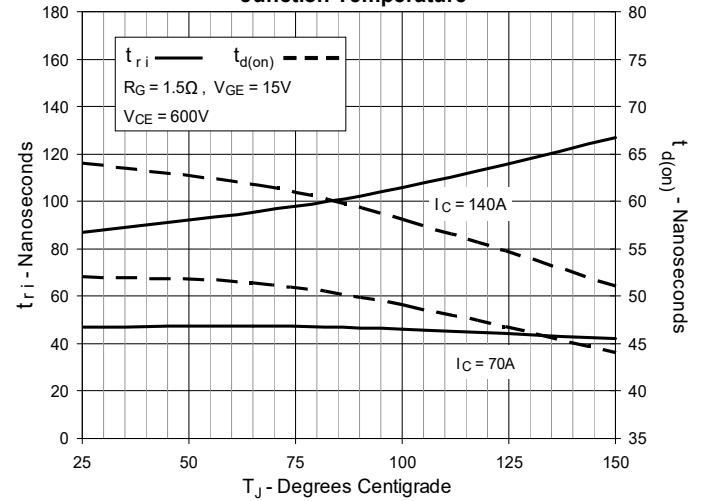
**Fig. 19. Inductive Turn-on Switching Times vs. Gate Resistance**

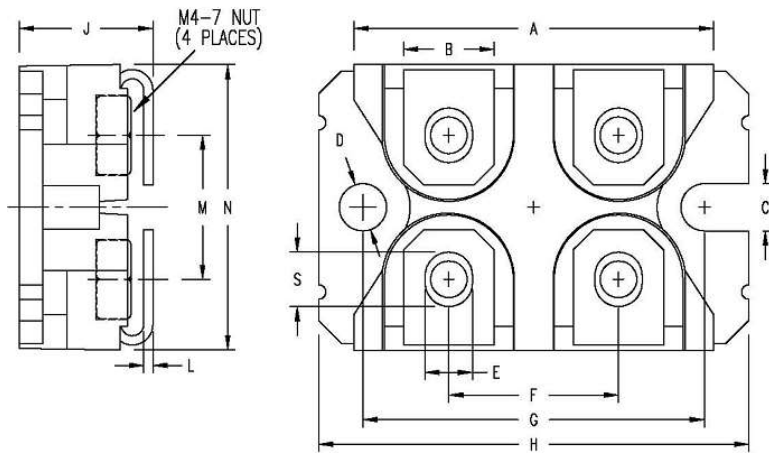


**Fig. 20. Inductive Turn-on Switching Times vs. Collector Current**

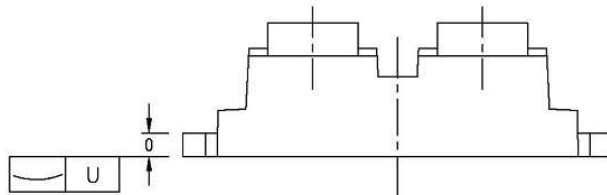


**Fig. 21. Inductive Turn-on Switching Times vs. Junction Temperature**



**SOT-227B miniBLOC (IXYN)**


SYM	INCHES		MILLIMETERS	
	MIN	MAX	MIN	MAX
A	1.224	1.260	31.10	32.00
B	.303	.327	7.70	8.30
C	.161	.173	4.10	4.40
D	.161	.173	4.10	4.40
E	.161	.173	4.10	4.40
F	.587	.598	14.90	15.20
G	1.181	1.201	30.00	30.50
H	1.488	1.508	37.80	38.30
J	.461	.484	11.70	12.30
L	.030	.033	0.75	0.85
M	.492	.512	12.50	13.00
N	.984	1.004	25.00	25.50
O	.075	.087	1.90	2.20
S	.181	.193	4.60	4.90
U	.000	.005	0.00	0.13



- NUT MATERIAL:  
 STANDARD - Low carbon steel with Ni plating.  
 OPTIONAL - Brass Nut is available.  
 PART NUMBER-BN
- ALL METAL SURFACE ARE PRE NI PLATED EXCEPT TRIM AREA.



---

Disclaimer Notice - Information furnished is believed to be accurate and reliable. However, users should independently evaluate the suitability of and test each product selected for their own applications. Littelfuse products are not designed for, and may not be used in, all applications. Read complete Disclaimer Notice at [www.littelfuse.com/disclaimer-electronics](http://www.littelfuse.com/disclaimer-electronics).

Littelfuse reserves the right to change limits, test conditions and dimensions.

---