

XPT™ 650V GenX5™ IGBT

IXYP60N65A5

$V_{CES} = 650V$
 $I_{C110} = 60A$
 $V_{CE(sat)} \leq 1.35V$
 $t_{fi(typ)} = 110ns$

Extreme Light Punch Through IGBT for up to 10kHz Switching

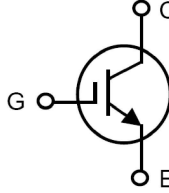

TO-220
(IXYP)

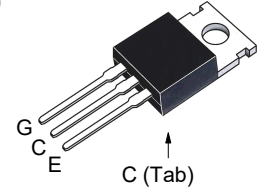

G = Gate C = Collector
 E = Emitter Tab = Collector

Symbol	Test Conditions	Maximum Ratings	
V_{CES}	$T_J = 25^\circ C$ to $175^\circ C$	650	V
V_{CGR}	$T_J = 25^\circ C$ to $175^\circ C$, $R_{GE} = 1M\Omega$	650	V
V_{GES}	Continuous	± 20	V
V_{GEM}	Transient	± 30	V
I_{C25}	$T_C = 25^\circ C$	134	A
I_{C110}	$T_C = 110^\circ C$	60	A
I_{CM}	$T_C = 25^\circ C$, 1ms	260	A
SSOA (RBSOA)	$V_{GE} = 15V$, $T_{VJ} = 150^\circ C$, $R_G = 5\Omega$ Clamped Inductive Load	$I_{CM} = 108$ @ $V_{CE} \leq V_{CES}$	A
P_c	$T_C = 25^\circ C$	395	W
T_J		-55 ... +175	$^\circ C$
T_{JM}		175	$^\circ C$
T_{stg}		-55 ... +175	$^\circ C$
T_L	Maximum Lead Temperature for Soldering 1.6 mm (0.062 in.) from Case for 10s	300	$^\circ C$
M_d	Mounting Torque	1.13 / 10	Nm/lb.in
Weight		3	g

Features

- Optimized for Low Frequency High Current Switching
- High Surge Current Capability
- Square RBSOA
- International Standard Packages

Advantages

- High Power Density
- Low Gate Drive Requirement

Applications

- Power Inverters
- UPS
- Motor Drives
- SMPS
- PFC Circuits
- Battery Chargers
- Welding Machines
- Lamp Ballasts

Symbol	Test Conditions ($T_J = 25^\circ C$, Unless Otherwise Specified)	Characteristic Values		
		Min.	Typ.	Max.
BV_{CES}	$I_C = 250\mu A$, $V_{GE} = 0V$	650		V
$V_{GE(th)}$	$I_C = 250\mu A$, $V_{CE} = V_{GE}$	3.7		5.8 V
I_{CES}	$V_{CE} = V_{CES}$, $V_{GE} = 0V$ $T_J = 150^\circ C$			10 μA 250 μA
I_{GES}	$V_{CE} = 0V$, $V_{GE} = \pm 20V$			± 100 nA
$V_{CE(sat)}$	$I_C = 36A$, $V_{GE} = 15V$, Note 1 $T_J = 150^\circ C$	1.23	1.35	V V

Symbol Test Conditions ($T_J = 25^\circ\text{C}$ Unless Otherwise Specified)		Characteristic Values		
		Min.	Typ.	Max.
g_{fs}	$I_C = 36\text{A}, V_{CE} = 10\text{V}$, Note 1	20	35	S
C_{ies}	$V_{CE} = 25\text{V}, V_{GE} = 0\text{V}, f = 1\text{MHz}$		1970	pF
C_{oes}			106	pF
C_{res}			80	pF
$Q_{g(on)}$	$I_C = 36\text{A}, V_{GE} = 15\text{V}, V_{CE} = 0.5 \cdot V_{CES}$		128	nC
Q_{ge}			13	nC
Q_{gc}			66	nC
$t_{d(on)}$	Inductive load, $T_J = 25^\circ\text{C}$ $I_C = 36\text{A}, V_{GE} = 15\text{V}$ $V_{CE} = 400\text{V}, R_G = 5\Omega$ Note 2		28	ns
t_{ri}			32	ns
E_{on}			0.60	mJ
$t_{d(off)}$			230	ns
t_{fi}			110	ns
E_{off}			1.45	mJ
$t_{d(on)}$	Inductive load, $T_J = 150^\circ\text{C}$ $I_C = 36\text{A}, V_{GE} = 15\text{V}$ $V_{CE} = 400\text{V}, R_G = 5\Omega$ Note 2		19	ns
t_{ri}			32	ns
E_{on}			1.10	mJ
$t_{d(off)}$			235	ns
t_{fi}			240	ns
E_{off}			2.50	mJ
R_{thJC}				0.38 $^\circ\text{C/W}$
R_{thCS}		0.50		$^\circ\text{C/W}$

Notes:

1. Pulse test, $t \leq 300\mu\text{s}$, duty cycle, $d \leq 2\%$.
2. Switching times & energy losses may increase for higher V_{CE} (clamp), T_J or R_G .

Littelfuse reserves the right to change limits, test conditions, and dimensions.

IXYS MOSFETs and IGBTs are covered	4,835,592	4,931,844	5,049,961	5,237,481	6,162,665	6,404,065 B1	6,683,344	6,727,585	7,005,734 B2	7,157,338B2
by one or more of the following U.S. patents:	4,860,072	5,017,508	5,063,307	5,381,025	6,259,123 B1	6,534,343	6,710,405 B2	6,759,692	7,063,975 B2	
	4,881,106	5,034,796	5,187,117	5,486,715	6,306,728 B1	6,583,505	6,710,463	6,771,478 B2	7,071,537	

Fig. 1. Output Characteristics @ $T_J = 25^\circ\text{C}$

Fig. 2. Extended Output Characteristics @ $T_J = 25^\circ\text{C}$

Fig. 3. Output Characteristics @ $T_J = 150^\circ\text{C}$

Fig. 4. Dependence of $V_{CE(sat)}$ on Junction Temperature

Fig. 5. Collector-to-Emitter Voltage vs. Gate-to-Emitter Voltage

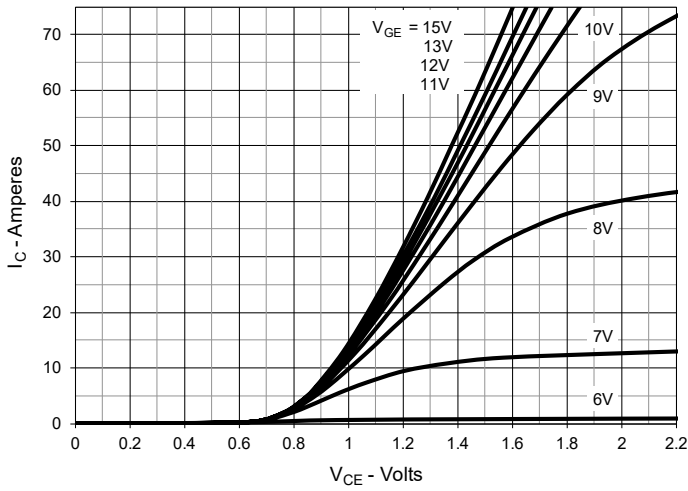
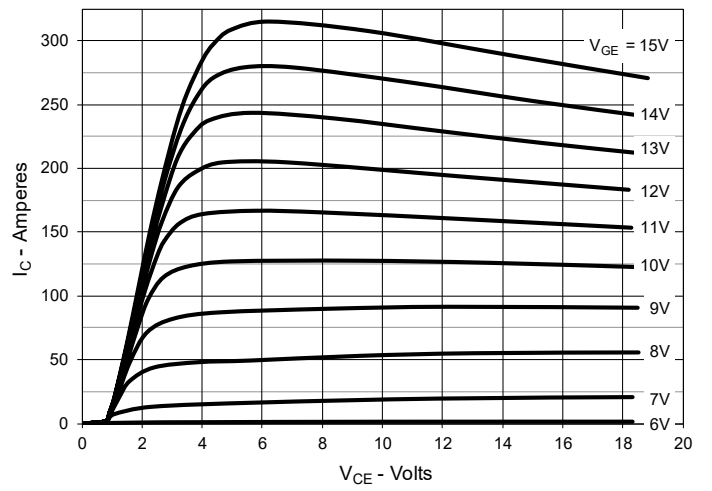
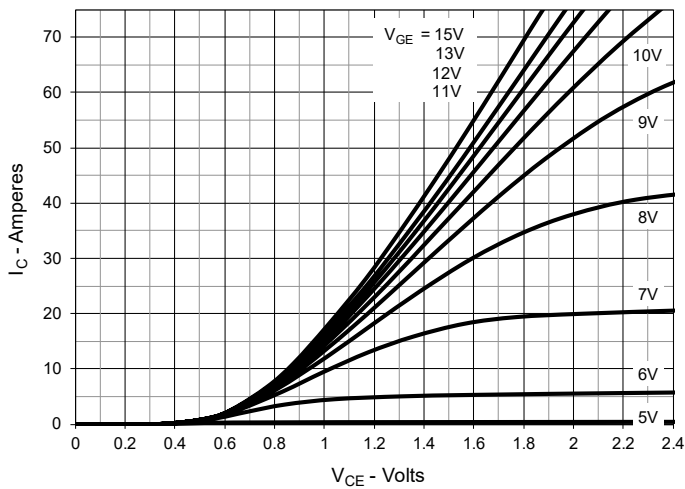
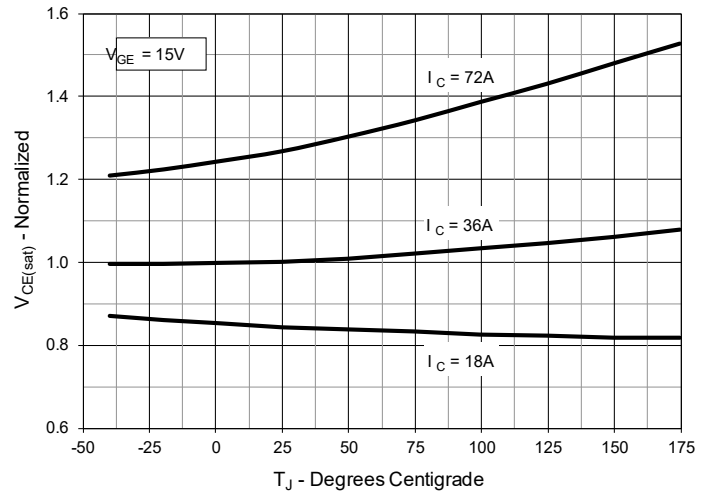
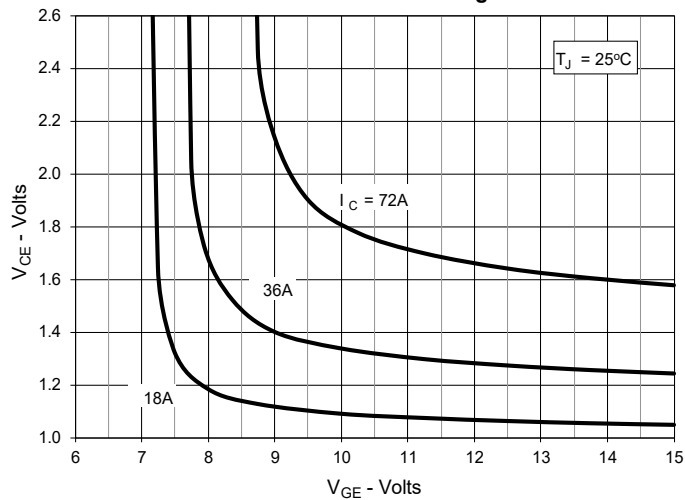
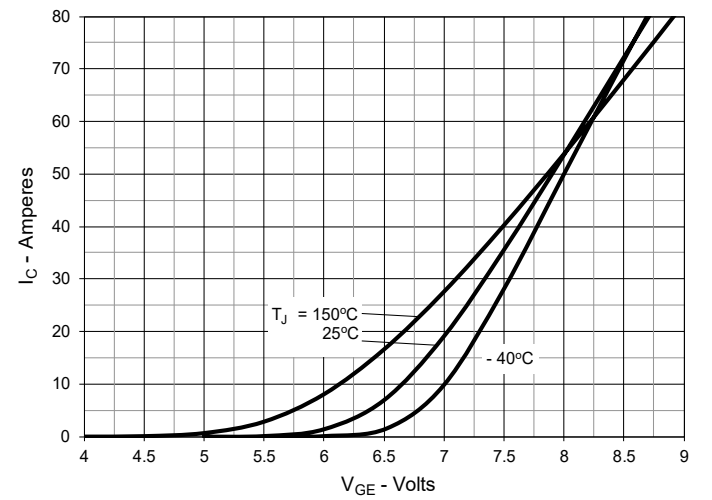
Fig. 6. Input Admittance

Fig. 7. Transconductance

Fig. 8. Gate Charge

Fig. 9. Capacitance

Fig. 10. Reverse-Bias Safe Operating Area

Fig. 11. Maximum Transient Thermal Impedance

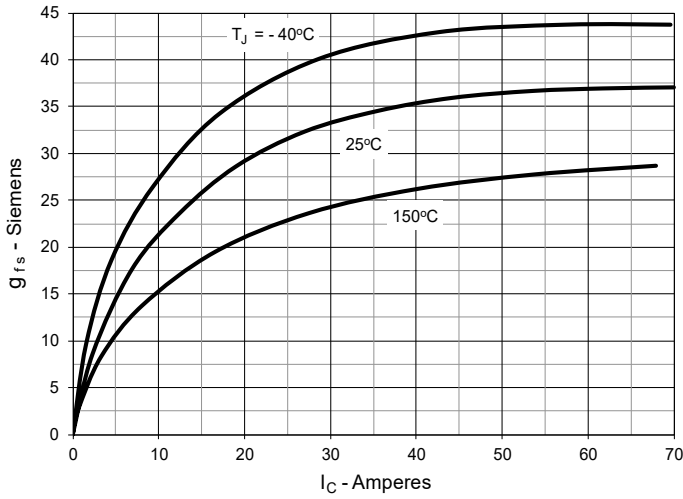
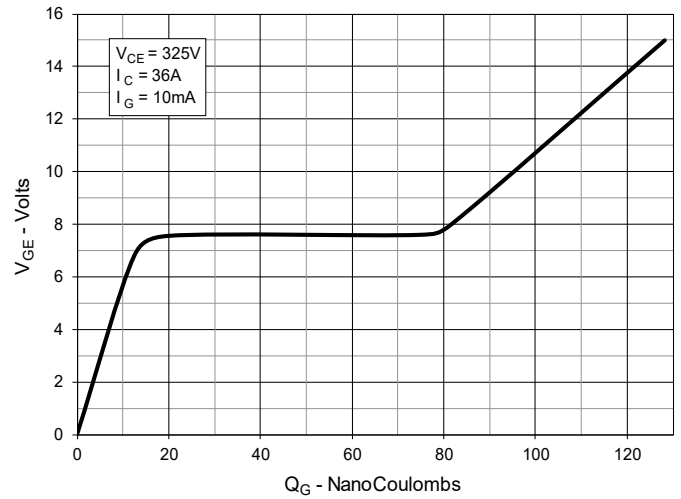
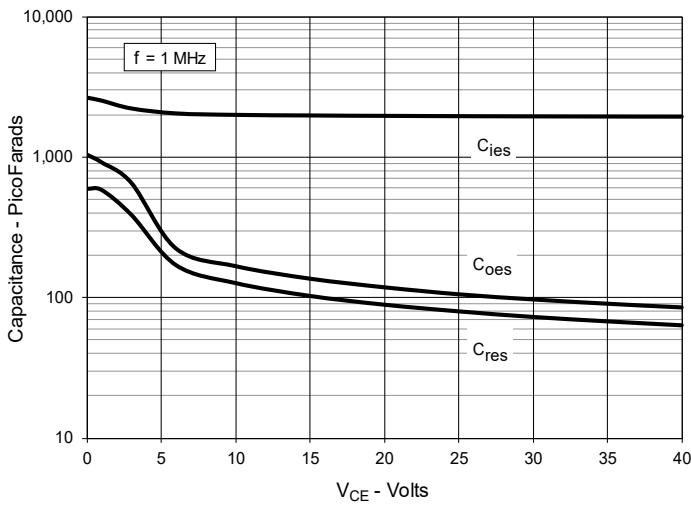
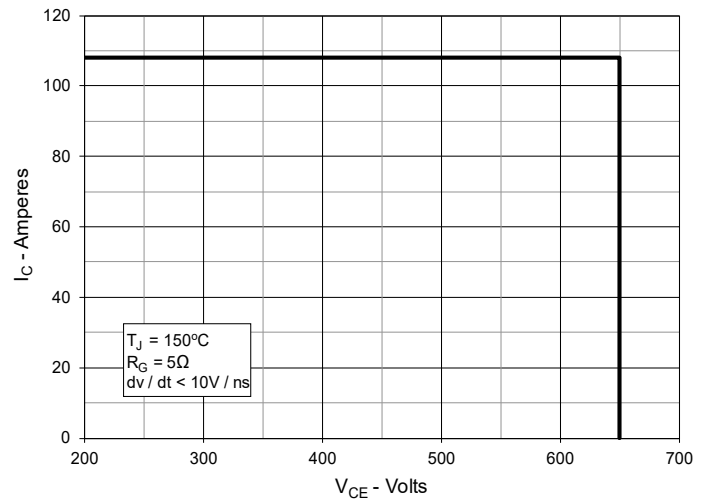
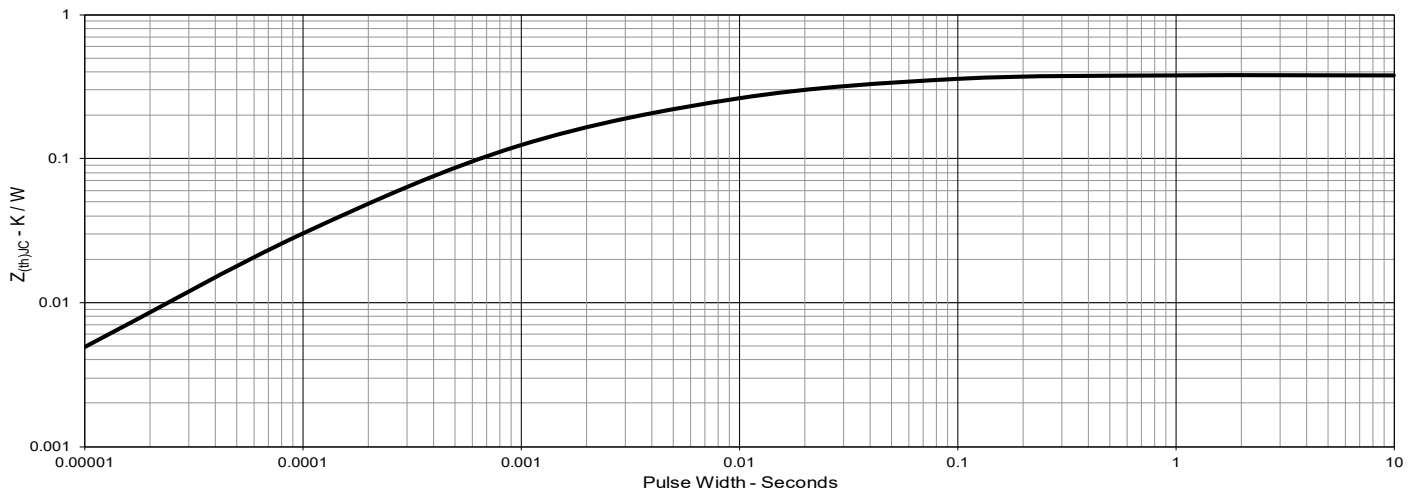
Fig. 12. Inductive Switching Energy Loss vs. Collector Current

Fig. 13. Inductive Switching Energy Loss vs. Gate Resistance

Fig. 14. Inductive Switching Energy Loss vs. Junction Temperature

Fig. 15. Inductive Turn-off Switching Times vs. Gate Resistance

Fig. 16. Inductive Turn-off Switching Times vs. Collector Current

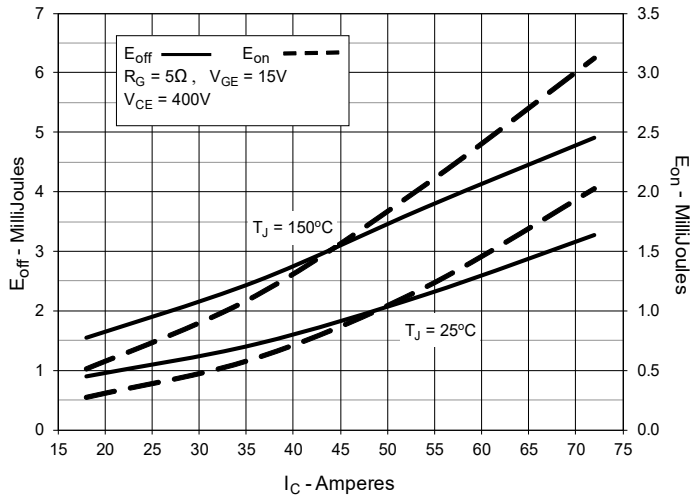
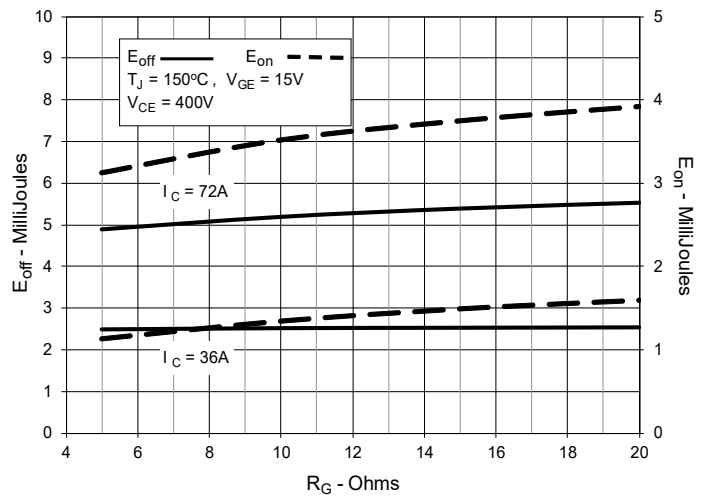
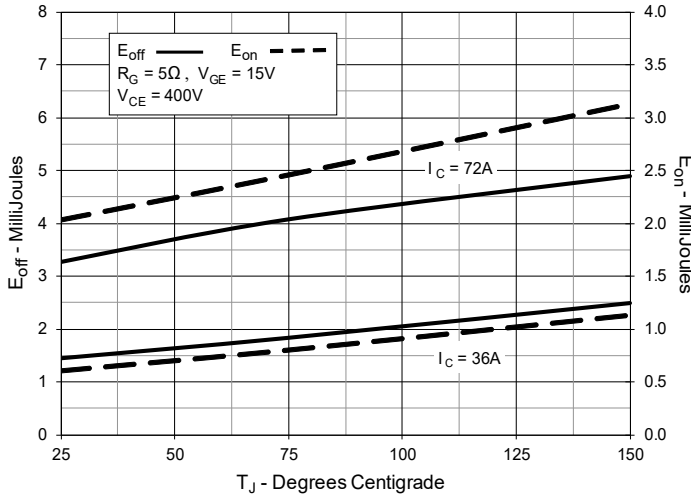
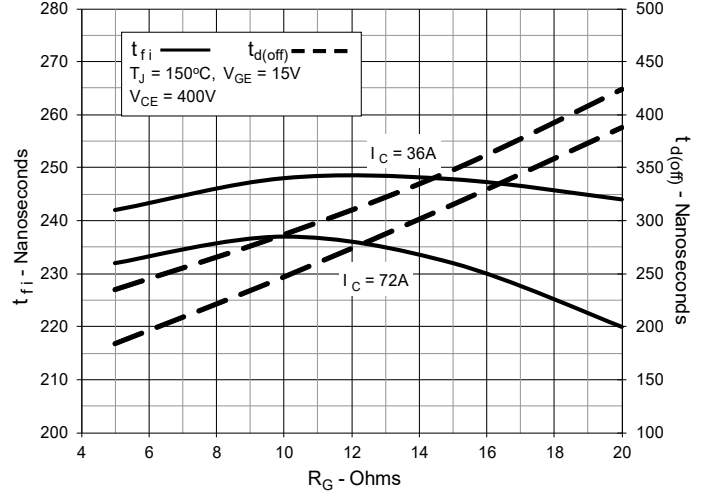
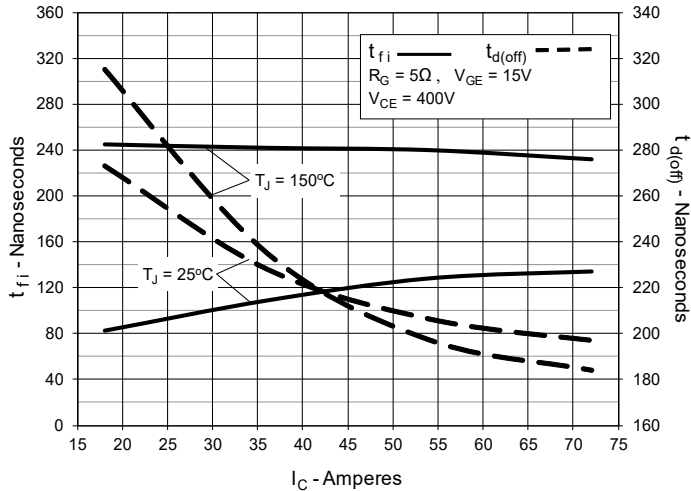
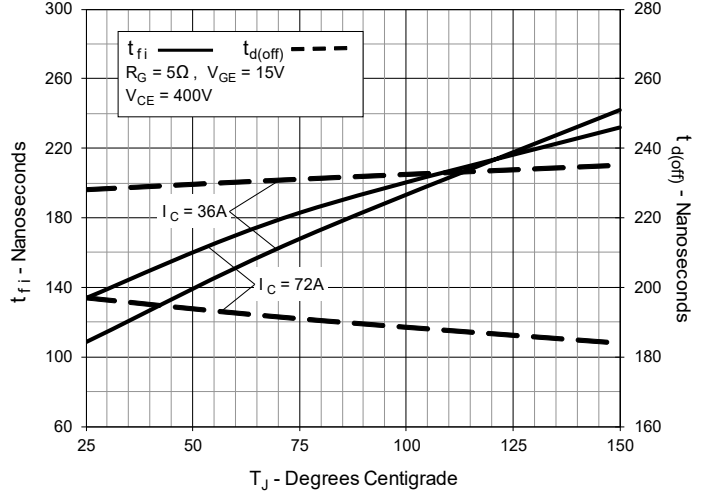
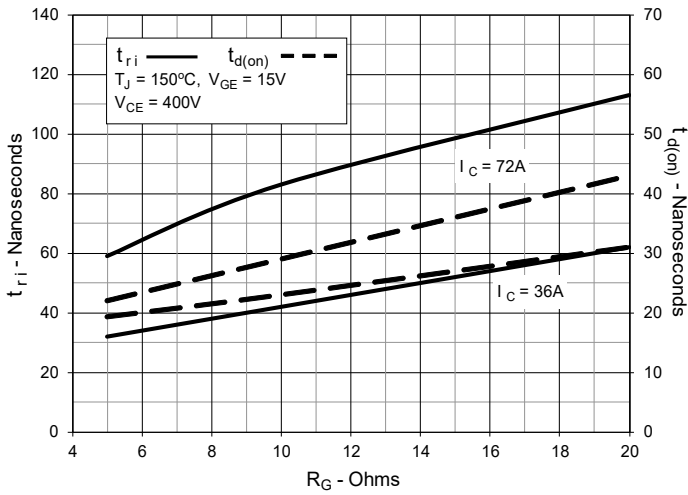
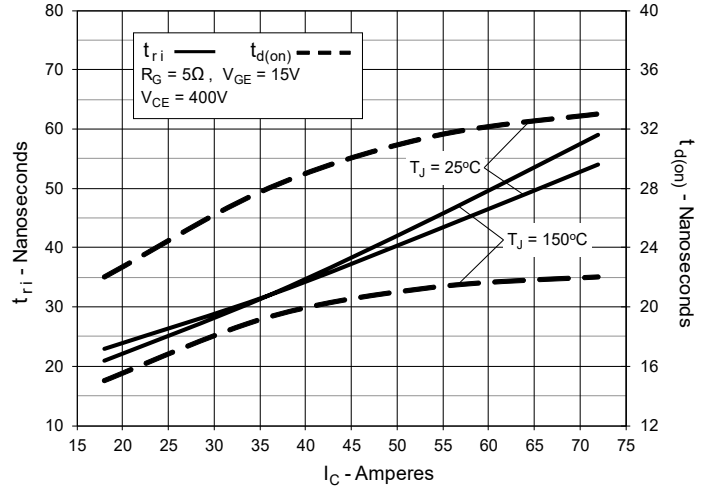
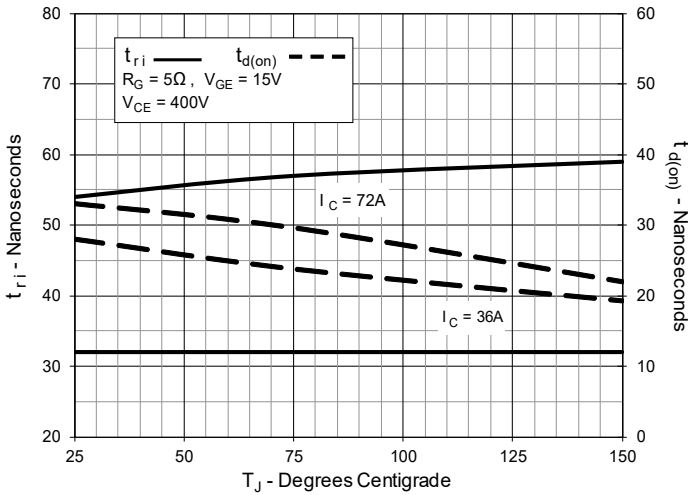
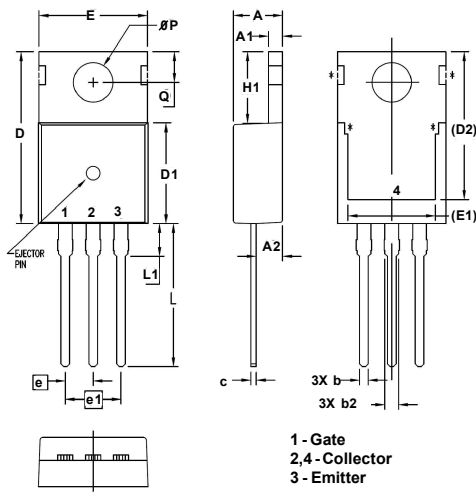
Fig. 17. Inductive Turn-off Switching Times vs. Junction Temperature

Fig. 18. Inductive Turn-on Switching Times vs. Gate Resistance

Fig. 19. Inductive Turn-on Switching Times vs. Collector Current

Fig. 20. Inductive Turn-on Switching Times vs. Junction Temperature

TO-220 Outline

SYM	INCHES		MILLIMETERS	
	MIN	MAX	MIN	MAX
A	.169	.185	4.30	4.70
A1	.047	.055	1.20	1.40
A2	.079	.106	2.00	2.70
b	.024	.039	0.60	1.00
b2	.045	.057	1.15	1.45
c	.014	.026	0.35	0.65
D	.587	.626	14.90	15.90
D1	.335	.370	8.50	9.40
(D2)	.500	.531	12.70	13.50
E	.382	.406	9.70	10.30
(E1)	.283	.323	7.20	8.20
e	.100 BSC		2.54 BSC	
e1	.200 BSC		5.08 BSC	
H1	.244	.268	6.20	6.80
L	.492	.547	12.50	13.90
L1	.110	.154	2.80	3.90
∅P	.134	.150	3.40	3.80
Q	.106	.126	2.70	3.20