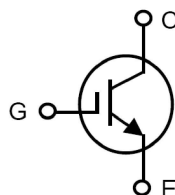


# 1200V XPT™ IGBT GenX4™

## IXYX140N120A4

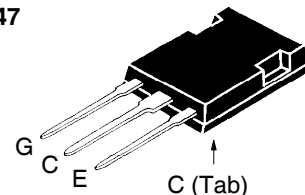
Ultra Low-V<sub>sat</sub> IGBT for  
up to 5kHz Switching



$V_{CES} = 1200V$   
 $I_{C110} = 140A$   
 $V_{CE(sat)} \leq 1.70V$   
 $t_{fi(typ)} = 320ns$

Symbol	Test Conditions	Maximum Ratings	
$V_{CES}$	$T_J = 25^\circ C$ to $175^\circ C$	1200	V
$V_{CGR}$	$T_J = 25^\circ C$ to $175^\circ C$ , $R_{GE} = 1M\Omega$	1200	V
$V_{GES}$	Continuous	$\pm 20$	V
$V_{GEM}$	Transient	$\pm 30$	V
$I_{C25}$	$T_C = 25^\circ C$ (Chip Capability)	480	A
$I_{LRMS}$	Terminal Current Limit	160	A
$I_{C110}$	$T_C = 110^\circ C$	140	A
$I_{CM}$	$T_C = 25^\circ C$ , 1ms	1200	A
<b>SSOA</b>	$V_{GE} = 15V$ , $T_{VJ} = 125^\circ C$ , $R_G = 2\Omega$	$I_{CM} = 280$	A
<b>(RBSOA)</b>	Clamped Inductive Load	$0.8 \cdot V_{CES}$	V
$P_C$	$T_C = 25^\circ C$	1500	W
$T_J$		-55 ... +175	$^\circ C$
$T_{JM}$		175	$^\circ C$
$T_{stg}$		-55 ... +175	$^\circ C$
$T_L$	Maximum Lead Temperature for Soldering 1.6 mm (0.062 in.) from Case for 10s	300	$^\circ C$
$F_C$	Mounting Force	20..120 /4.5..27	N/lb
<b>Weight</b>		6	g

PLUS247  
(IXYX)



G = Gate      C = Collector  
E = Emitter    Tab = Collector

### Features

- Optimized for Low Conduction Losses
- Positive Thermal Coefficient of V<sub>ce(sat)</sub>
- International Standard Package

### Advantages

- High Power Density
- Low Gate Drive Requirement

### Applications

- Power Inverters
- UPS
- Motor Drives
- SMPS
- PFC Circuits
- Battery Chargers
- Welding Machines
- Lamp Ballasts
- Inrush Current Protection Circuits

Symbol	Test Conditions ( $T_J = 25^\circ C$ , Unless Otherwise Specified)	Characteristic Values		
		Min.	Typ.	Max.
$BV_{CES}$	$I_C = 250\mu A$ , $V_{GE} = 0V$	1200		V
$V_{GE(th)}$	$I_C = 4mA$ , $V_{CE} = V_{GE}$	4.5		6.5 V
$I_{CES}$	$V_{CE} = V_{CES}$ , $V_{GE} = 0V$ $T_J = 125^\circ C$			25 $\mu A$ 5 mA
$I_{GES}$	$V_{CE} = 0V$ , $V_{GE} = \pm 20V$			$\pm 200$ nA
$V_{CE(sat)}$	$I_C = I_{C110}$ , $V_{GE} = 15V$ , Note 1 $T_J = 150^\circ C$		1.34 1.50	1.70 V V

Symbol Test Conditions ( $T_J = 25^\circ\text{C}$ Unless Otherwise Specified)		Characteristic Values		
		Min.	Typ.	Max.
$g_{fs}$	$I_C = 60\text{A}, V_{CE} = 10\text{V}, \text{Note 1}$	60	100	S
$C_{ies}$	$V_{CE} = 25\text{V}, V_{GE} = 0\text{V}, f = 1\text{MHz}$		8300	pF
$C_{oes}$			470	pF
$C_{res}$			300	pF
$Q_{g(on)}$	$I_C = I_{C110}, V_{GE} = 15\text{V}, V_{CE} = 0.5 \cdot V_{CES}$		420	nC
$Q_{ge}$			68	nC
$Q_{gc}$			210	nC
$t_{d(on)}$	<b>Inductive load, <math>T_J = 25^\circ\text{C}</math></b> $I_C = 70\text{A}, V_{GE} = 15\text{V}$ $V_{CE} = 0.5 \cdot V_{CES}, R_G = 1.5\Omega$ Note 2		52	ns
$t_{ri}$			47	ns
$E_{on}$			4.9	mJ
$t_{d(off)}$			590	ns
$t_{fi}$			320	ns
$E_{off}$			12.0	mJ
$t_{d(on)}$	<b>Inductive load, <math>T_J = 150^\circ\text{C}</math></b> $I_C = 70\text{A}, V_{GE} = 15\text{V}$ $V_{CE} = 0.5 \cdot V_{CES}, R_G = 1.5\Omega$ Note 2		44	ns
$t_{ri}$			42	ns
$E_{on}$			7.4	mJ
$t_{d(off)}$			710	ns
$t_{fi}$			530	ns
$E_{off}$			20.0	mJ
$R_{thJC}$				0.10 $^\circ\text{C/W}$
$R_{thCS}$		0.15		$^\circ\text{C/W}$

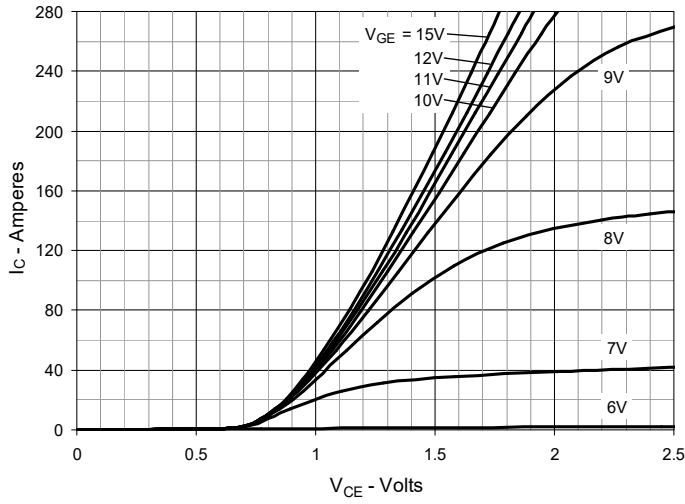
**Notes:**

1. Pulse test,  $t \leq 300\mu\text{s}$ , duty cycle,  $d \leq 2\%$ .
2. Switching times & energy losses may increase for higher  $V_{CE}$  (clamp),  $T_J$  or  $R_G$ .

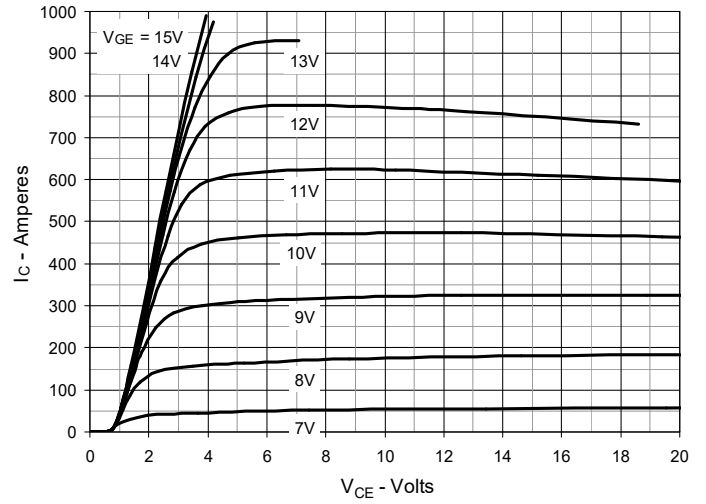
Littelfuse reserves the right to change limits, test conditions and dimensions.

IXYS MOSFETs and IGBTs are covered	4,835,592	4,931,844	5,049,961	5,237,481	6,162,665	6,404,065 B1	6,683,344	6,727,585	7,005,734 B2	7,157,338B2
by one or more of the following U.S. patents:	4,860,072	5,017,508	5,063,307	5,381,025	6,259,123 B1	6,534,343	6,710,405 B2	6,759,692	7,063,975 B2	
	4,881,106	5,034,796	5,187,117	5,486,715	6,306,728 B1	6,583,505	6,710,463	6,771,478 B2	7,071,537	

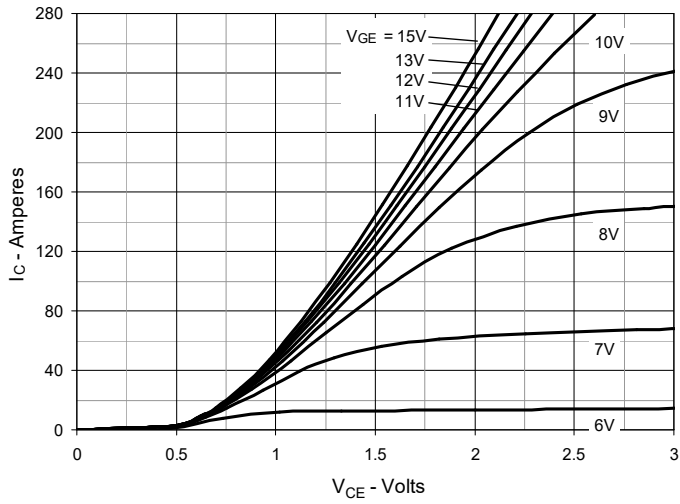
**Fig. 1. Output Characteristics @  $T_J = 25^\circ\text{C}$**



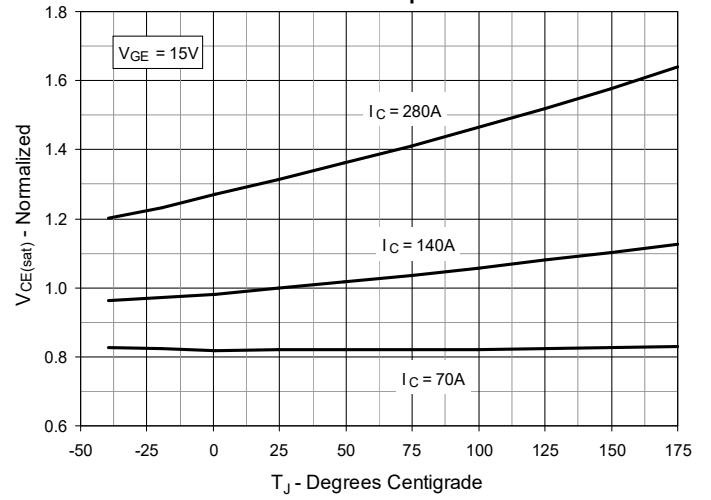
**Fig. 2. Extended Output Characteristics @  $T_J = 25^\circ\text{C}$**



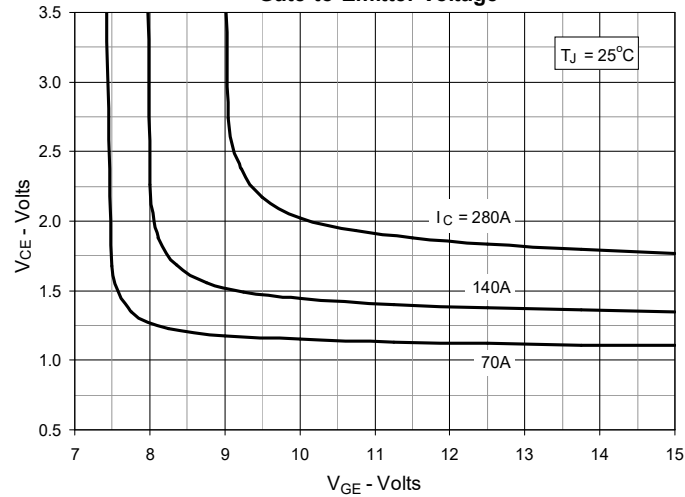
**Fig. 3. Output Characteristics @  $T_J = 150^\circ\text{C}$**



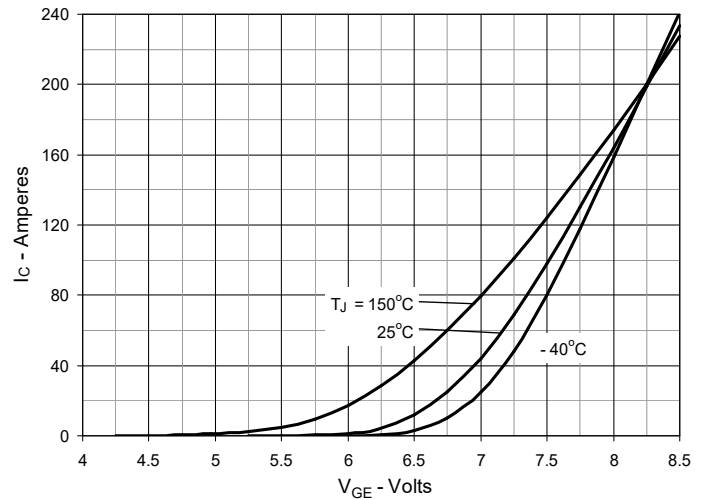
**Fig. 4. Dependence of  $V_{CE(sat)}$  on Junction Temperature**

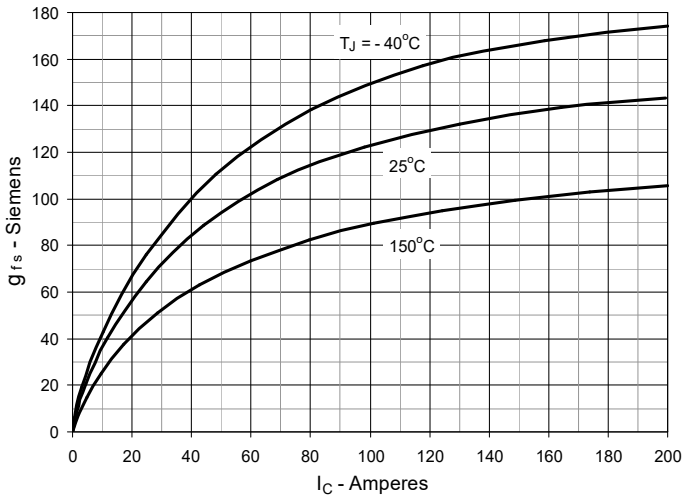
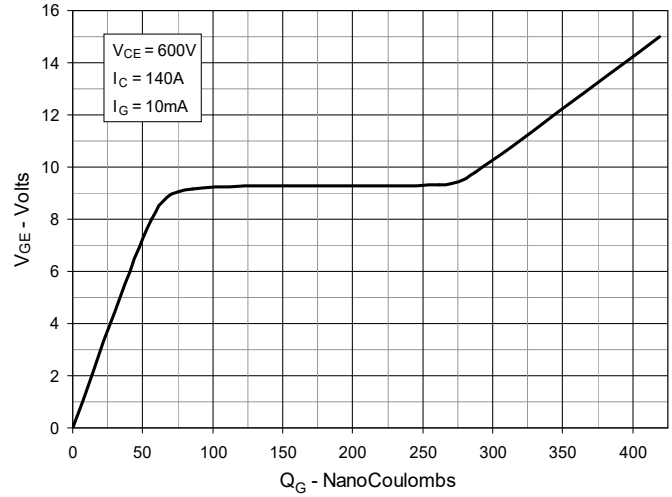
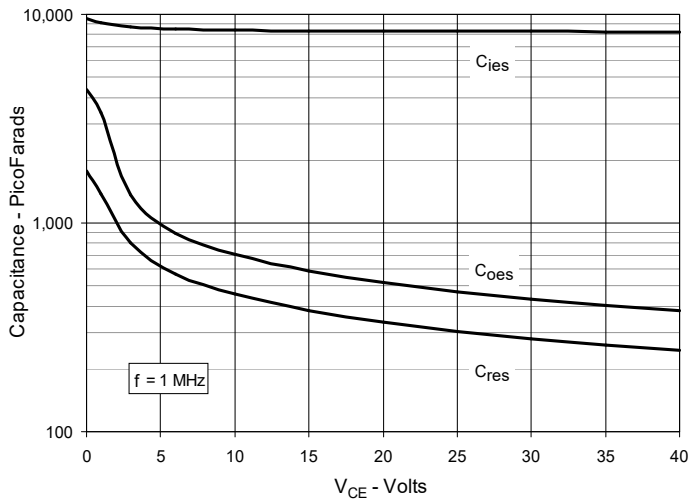
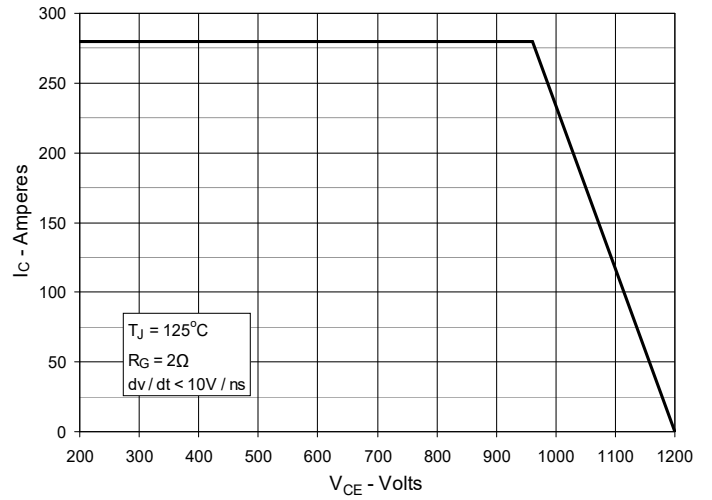
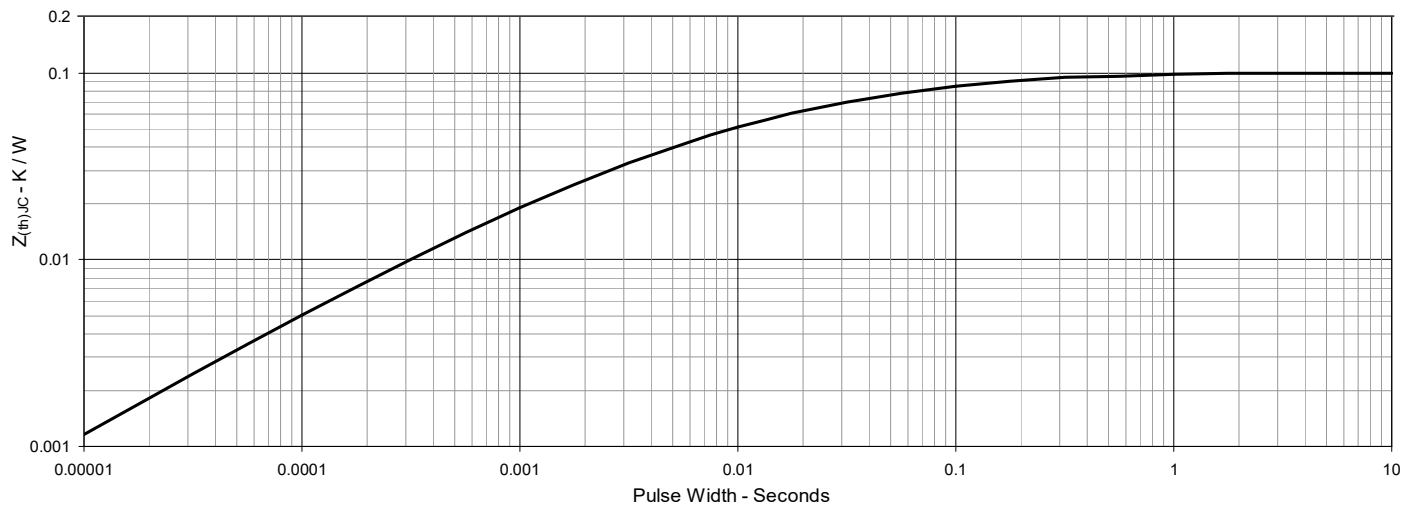


**Fig. 5. Collector-to-Emitter Voltage vs. Gate-to-Emitter Voltage**

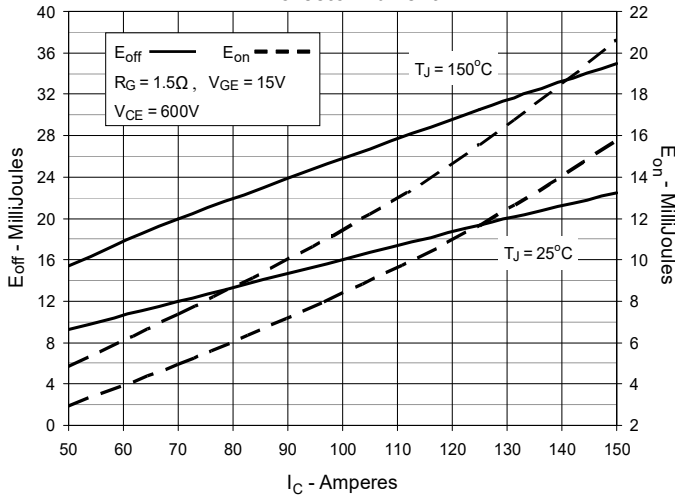


**Fig. 6. Input Admittance**

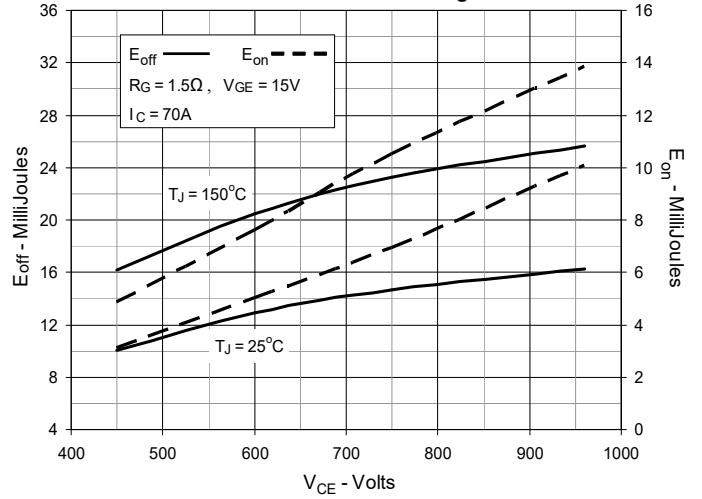


**Fig. 7. Transconductance**

**Fig. 8. Gate Charge**

**Fig. 9. Capacitance**

**Fig. 10. Reverse-Bias Safe Operating Area**

**Fig. 11. Maximum Transient Thermal Impedance**


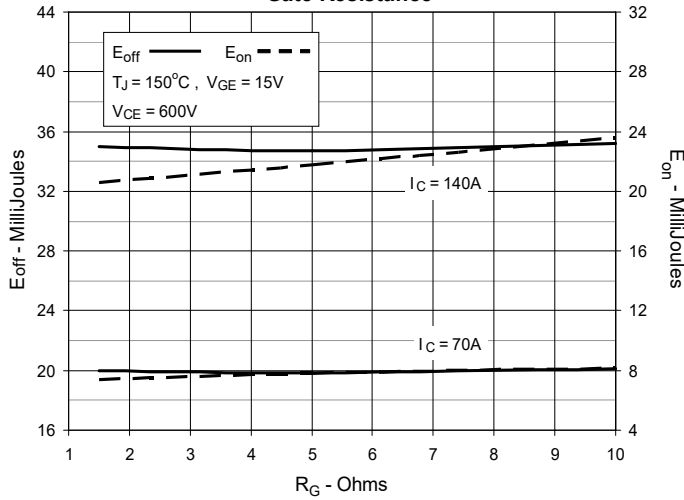
**Fig. 12. Inductive Switching Energy Loss vs. Collector Current**



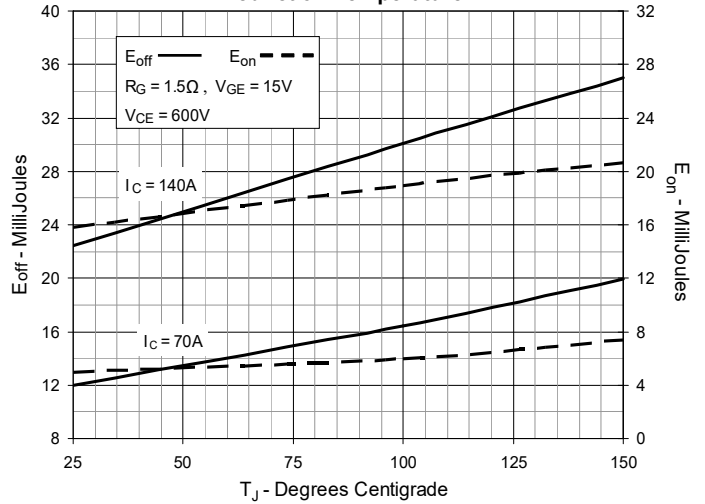
**Fig. 13. Inductive Switching Energy Loss vs. Collector-Emitter Voltage**



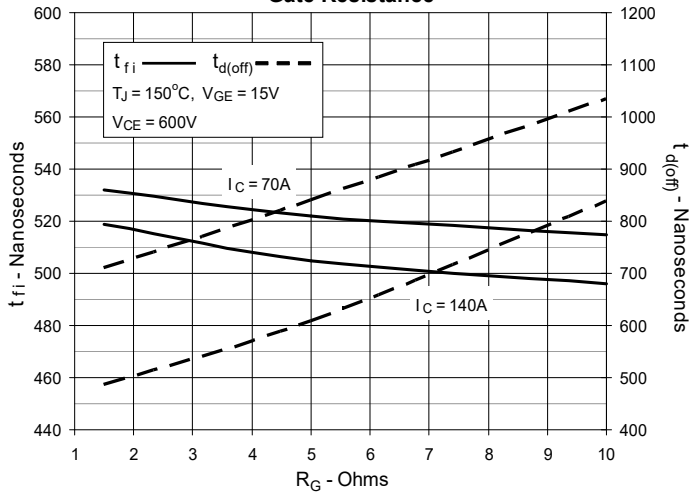
**Fig. 14. Inductive Switching Energy Loss vs. Gate Resistance**



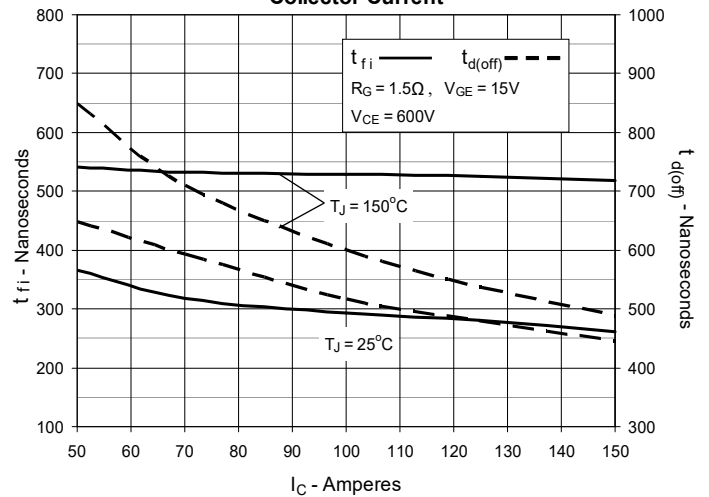
**Fig. 15. Inductive Switching Energy Loss vs. Junction Temperature**



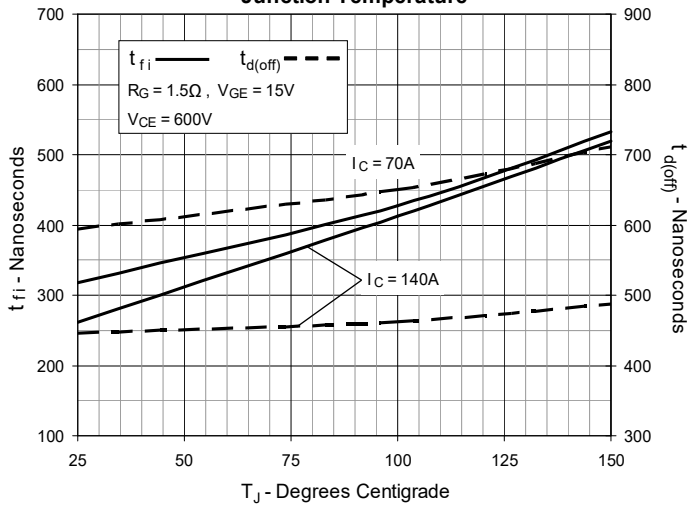
**Fig. 16. Inductive Turn-off Switching Times vs. Gate Resistance**



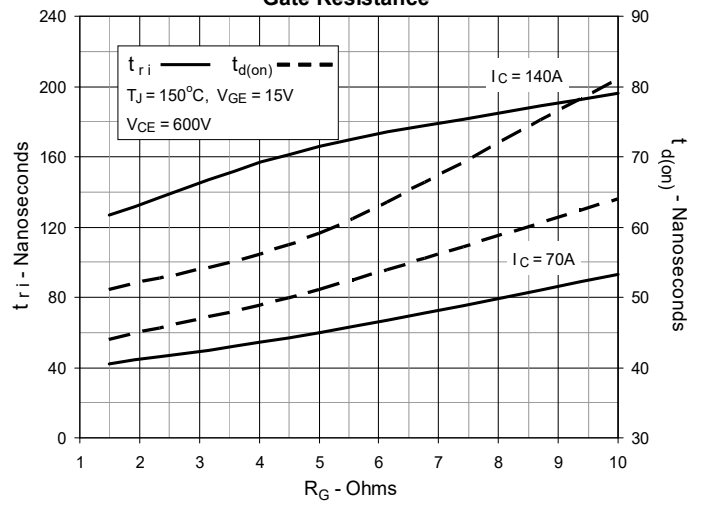
**Fig. 17. Inductive Turn-off Switching Times vs. Collector Current**



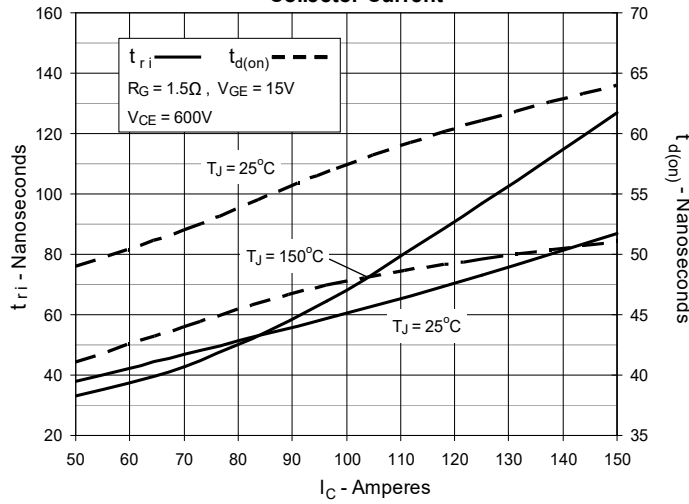
**Fig. 18. Inductive Turn-off Switching Times vs. Junction Temperature**



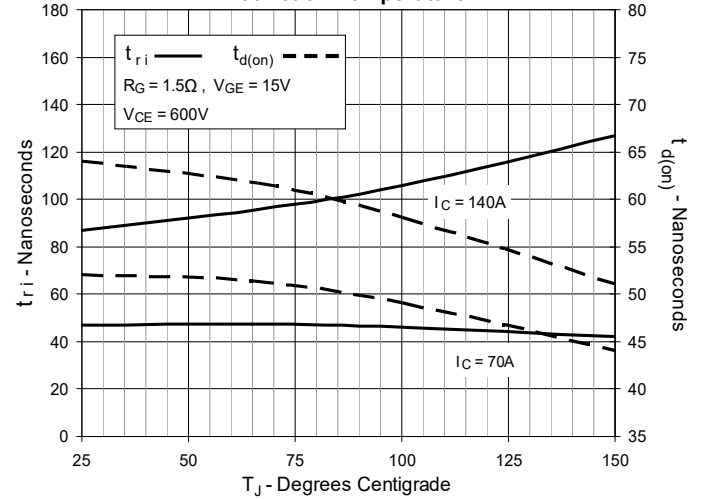
**Fig. 19. Inductive Turn-on Switching Times vs. Gate Resistance**

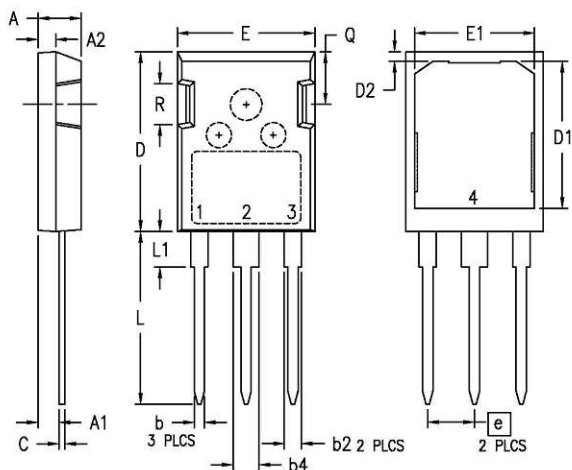


**Fig. 20. Inductive Turn-on Switching Times vs. Collector Current**



**Fig. 21. Inductive Turn-on Switching Times vs. Junction Temperature**



**PLUS247 Outline**


SYM	INCHES		MILLIMETERS	
	MIN	MAX	MIN	MAX
A	.190	.205	4.83	5.21
A1	.090	.100	2.29	2.54
A2	.075	.085	1.91	2.16
b	.045	.055	1.14	1.40
b2	.075	.087	1.91	2.20
b4	.115	.126	2.92	3.20
C	.024	.031	0.61	0.80
D	.819	.840	20.80	21.34
D1	.650	.690	16.51	17.53
D2	.035	.050	0.89	1.27
E	.620	.635	15.75	16.13
E1	.520	.560	13.08	14.22
e	.215 BSC		5.45 BSC	
L	.780	.810	19.81	20.57
L1	.150	.170	3.81	4.32
Q	.220	.244	5.59	6.20
R	.170	.190	4.32	4.83

- 1 - Gate**
- 2,4 - Collector**
- 3 - Emitter**

NOTE: 1. This drawing will meet all dimensions requirement of JEDEC outline TO-247 AD (R-PSIP-F3) except screw mounting hole.  
 2. Pin #2 is connected to the bottom heatsink (#4).  
 3. Lead finish - One of the following depending on the packaging plants.  
 3.1 Matte pure tin plating on the leads and back heatsink.  
 3.2 Pb free solder dip on the leads and pre Ni plated back heatsink.



---

Disclaimer Notice - Information furnished is believed to be accurate and reliable. However, users should independently evaluate the suitability of and test each product selected for their own applications. Littelfuse products are not designed for, and may not be used in, all applications. Read complete Disclaimer Notice at [www.littelfuse.com/disclaimer-electronics](http://www.littelfuse.com/disclaimer-electronics).

Littelfuse reserves the right to change limits, test conditions and dimensions.

---