

**Depletion Mode
MOSFET**

**IXTY1R6N100D2
IXTA1R6N100D2
IXTP1R6N100D2**

**$V_{DSX} = 1000V$
 $I_{D(on)} \geq 1.6A$
 $R_{DS(on)} \leq 10\Omega$**

N-Channel

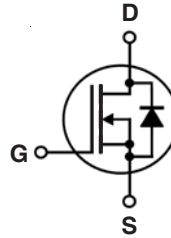

TO-252 (IXTY)

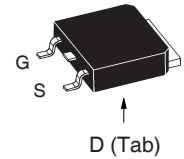

TO-263 AA (IXTA)

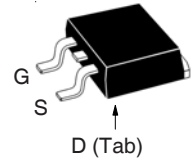

TO-220AB (IXTP)

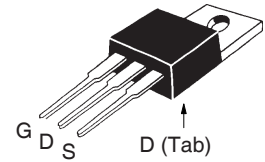

G = Gate D = Drain
S = Source Tab = Drain

Symbol	Test Conditions	Maximum Ratings	
V_{DSX}	$T_J = 25^\circ\text{C to } 150^\circ\text{C}$	1000	V
V_{GSX}	Continuous	± 20	V
V_{GSM}	Transient	± 30	V
P_D	$T_C = 25^\circ\text{C}$	100	W
T_J		- 55 ... +150	$^\circ\text{C}$
T_{JM}		150	$^\circ\text{C}$
T_{stg}		- 55 ... +150	$^\circ\text{C}$
T_L	Maximum Lead Temperature for Soldering	300	$^\circ\text{C}$
T_{SOLD}	1.6 mm (0.062in.) from Case for 10s	260	$^\circ\text{C}$
M_d	Mounting Torque (TO-220)	1.13 / 10	Nm/lb.in.
Weight	TO-252	0.35	g
	TO-263	2.50	g
	TO-220	3.00	g

Symbol	Test Conditions ($T_J = 25^\circ\text{C}$, Unless Otherwise Specified)	Characteristic Values		
		Min.	Typ.	Max.
BV_{DSX}	$V_{GS} = -5V, I_D = 250\mu\text{A}$	1000		V
$V_{GS(off)}$	$V_{DS} = 25V, I_D = 100\mu\text{A}$	- 2.5		- 4.5 V
I_{GSX}	$V_{GS} = \pm 20V, V_{DS} = 0V$			± 100 nA
$I_{DSX(off)}$	$V_{DS} = V_{DSX}, V_{GS} = -5V$ $T_J = 125^\circ\text{C}$			2 μA 25 μA
$R_{DS(on)}$	$V_{GS} = 0V, I_D = 0.8A$, Note 1			10 Ω
$I_{D(on)}$	$V_{GS} = 0V, V_{DS} = 50V$, Note 1	1.6		A

Features

- Normally ON Mode
- International Standard Packages
- Molding Epoxies Meet UL 94 V-0 Flammability Classification

Advantages

- Easy to Mount
- Space Savings
- High Power Density

Applications

- Audio Amplifiers
- Start-Up Circuits
- Protection Circuits
- Ramp Generators
- Current Regulators
- Active Loads

Symbol	Test Conditions ($T_J = 25^\circ\text{C}$, Unless Otherwise Specified)	Characteristic Values		
		Min.	Typ.	Max.
g_{fs}	$V_{DS} = 30\text{V}$, $I_D = 0.8\text{A}$, Note 1	0.65	1.10	S
C_{iss}	$V_{GS} = -10\text{V}$, $V_{DS} = 25\text{V}$, $f = 1\text{MHz}$		645	pF
C_{oss}			43	pF
C_{rss}			11	pF
$t_{d(on)}$	Resistive Switching Times $V_{GS} = \pm 5\text{V}$, $V_{DS} = 500\text{V}$, $I_D = 0.8\text{A}$ $R_G = 5\Omega$ (External)		27	ns
t_r			65	ns
$t_{d(off)}$			34	ns
t_f			41	ns
$Q_{g(on)}$	$V_{GS} = 5\text{V}$, $V_{DS} = 500\text{V}$, $I_D = 0.8\text{A}$		27.0	nC
Q_{gs}			1.6	nC
Q_{gd}			13.5	nC
R_{thJC}	TO-220			1.25 $^\circ\text{C/W}$
R_{thCS}			0.50	$^\circ\text{C/W}$

Safe-Operating-Area Specification

Symbol	Test Conditions	Characteristic Values		
		Min.	Typ.	Max.
SOA	$V_{DS} = 800\text{V}$, $I_D = 75\text{mA}$, $T_C = 75^\circ\text{C}$, $T_p = 5\text{s}$	60		W

Source-Drain Diode

Symbol	Test Conditions ($T_J = 25^\circ\text{C}$, Unless Otherwise Specified)	Characteristic Values		
		Min.	Typ.	Max.
V_{SD}	$I_F = 1.6\text{A}$, $V_{GS} = -10\text{V}$, Note 1		0.8	1.3 V
t_{rr}	$I_F = 1.6\text{A}$, $-di/dt = 100\text{A}/\mu\text{s}$ $V_R = 100\text{V}$, $V_{GS} = -10\text{V}$		970	ns
I_{RM}			9.96	A
Q_{RM}			4.80	μC

Note 1. Pulse test, $t \leq 300\mu\text{s}$, duty cycle, $d \leq 2\%$.

IXYS Reserves the Right to Change Limits, Test Conditions, and Dimensions.

IXYS MOSFETs and IGBTs are covered by one or more of the following U.S. patents:

4,835,592	4,931,844	5,049,961	5,237,481	6,162,665	6,404,065 B1	6,683,344	6,727,585	7,005,734 B2	7,157,338B2
4,860,072	5,017,508	5,063,307	5,381,025	6,259,123 B1	6,534,343	6,710,405 B2	6,759,692	7,063,975 B2	
4,881,106	5,034,796	5,187,117	5,486,715	6,306,728 B1	6,583,505	6,710,463	6,771,478 B2	7,071,537	

Fig. 1. Output Characteristics @ $T_J = 25^\circ\text{C}$

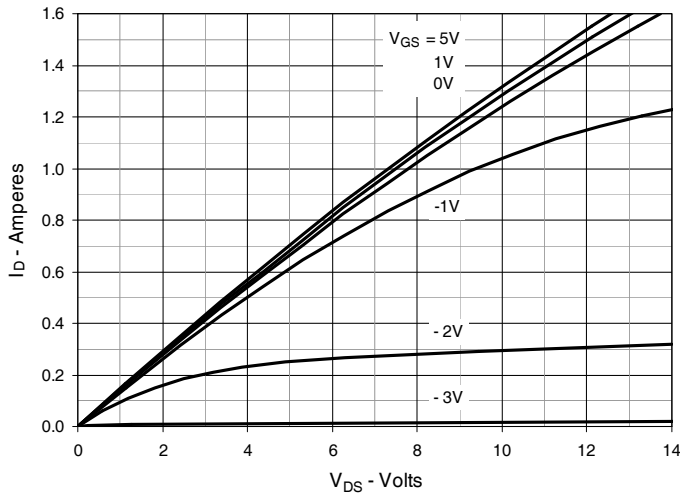

Fig. 2. Extended Output Characteristics @ $T_J = 25^\circ\text{C}$

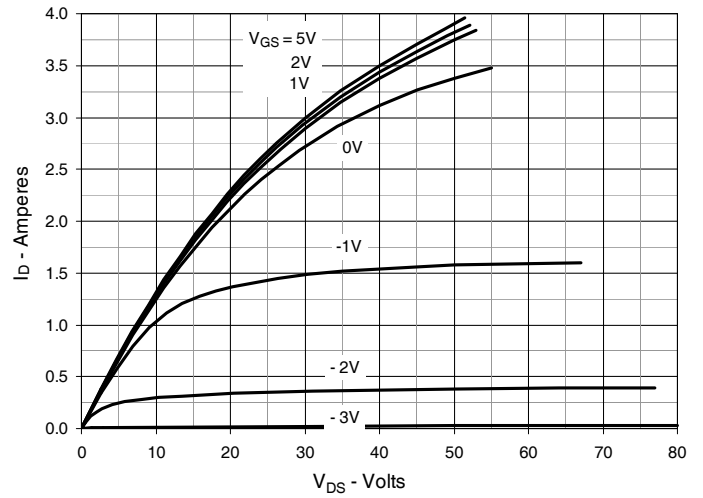

Fig. 3. Output Characteristics @ $T_J = 125^\circ\text{C}$

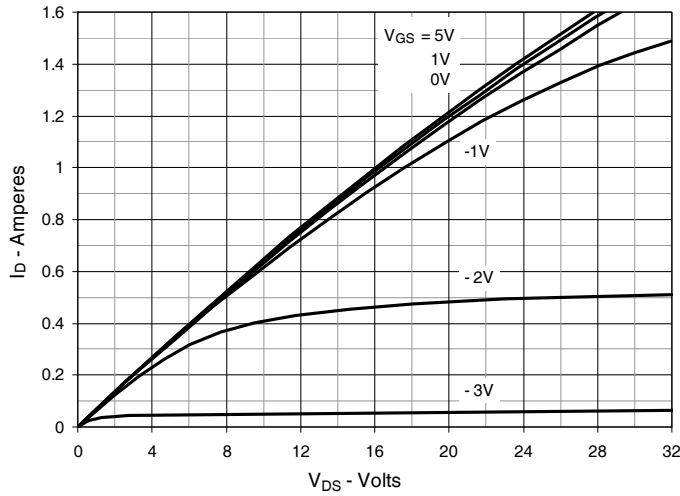

Fig. 4. Drain Current @ $T_J = 25^\circ\text{C}$

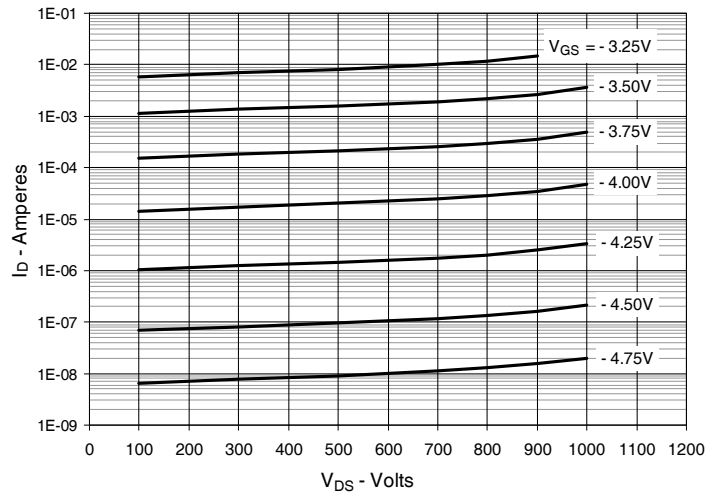

Fig. 5. Drain Current @ $T_J = 100^\circ\text{C}$

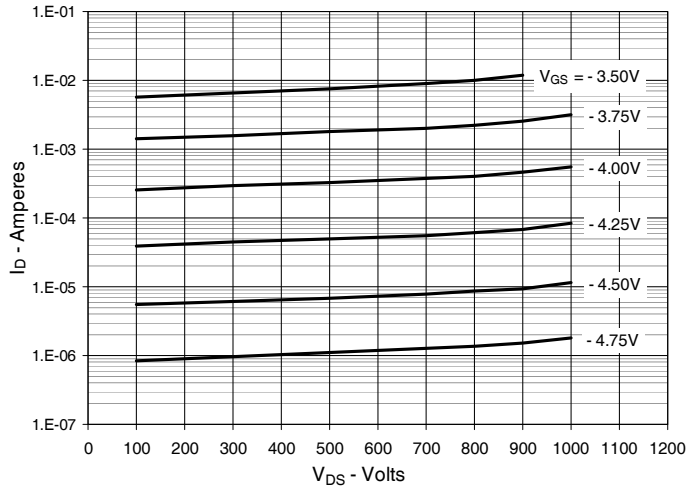

Fig. 6. Dynamic Resistance vs. Gate Voltage

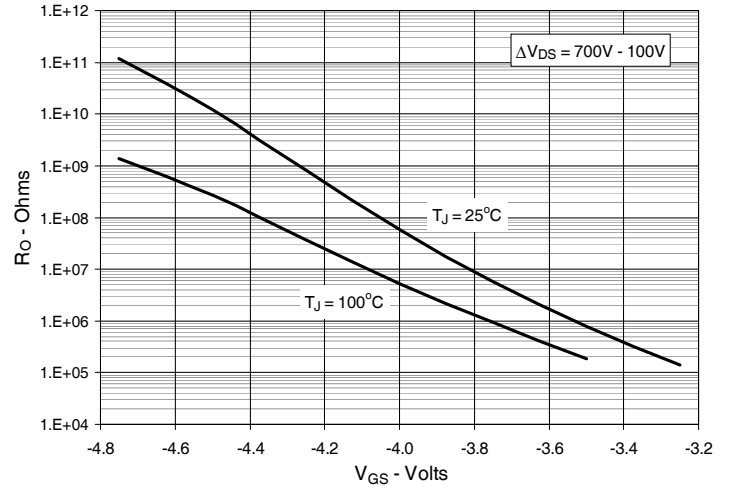

Fig. 7. Normalized $R_{DS(on)}$ vs. Junction Temperature

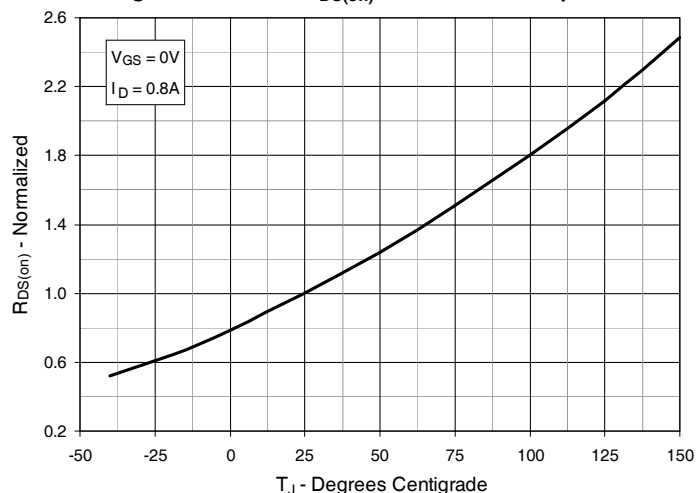

Fig. 8. $R_{DS(on)}$ Normalized to $I_D = 0.8A$ Value vs. Drain Current

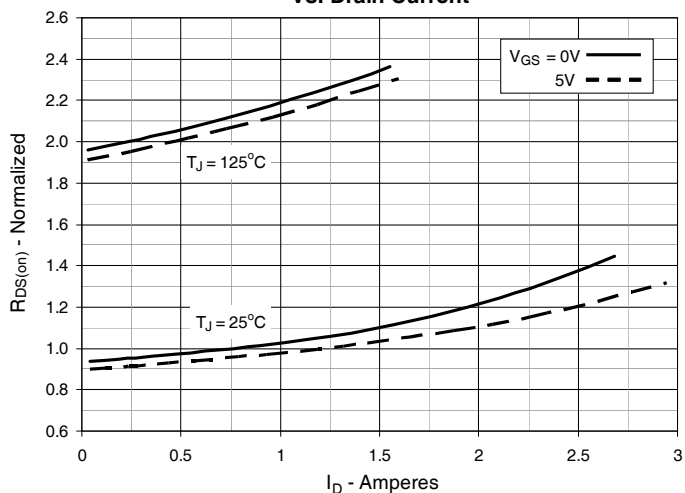

Fig. 9. Input Admittance

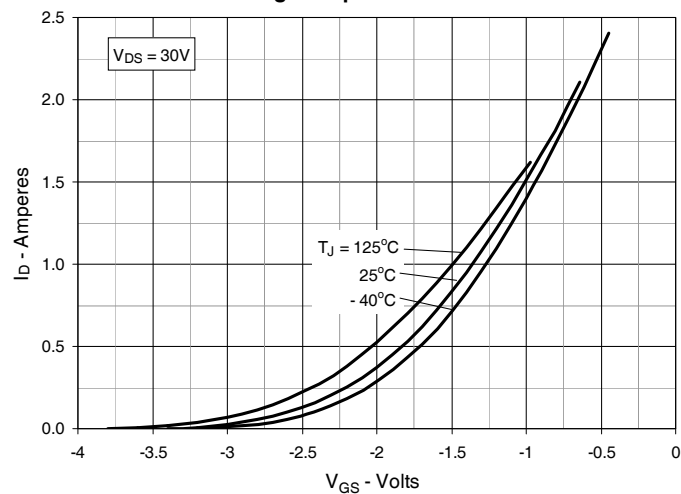

Fig. 10. Transconductance

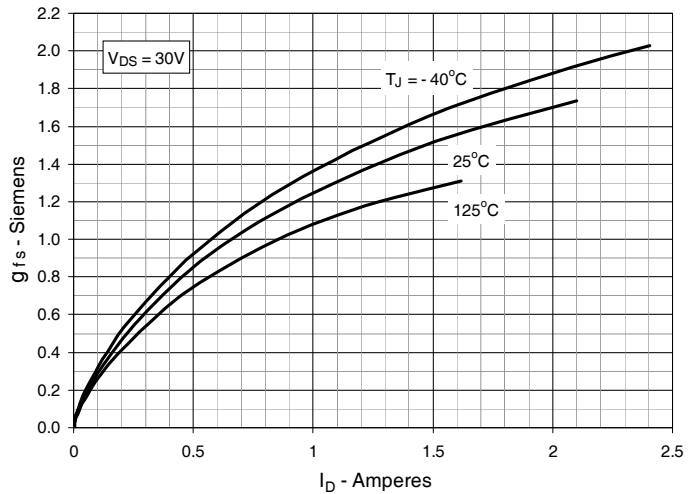

Fig. 11. Breakdown and Threshold Voltages vs. Junction Temperature

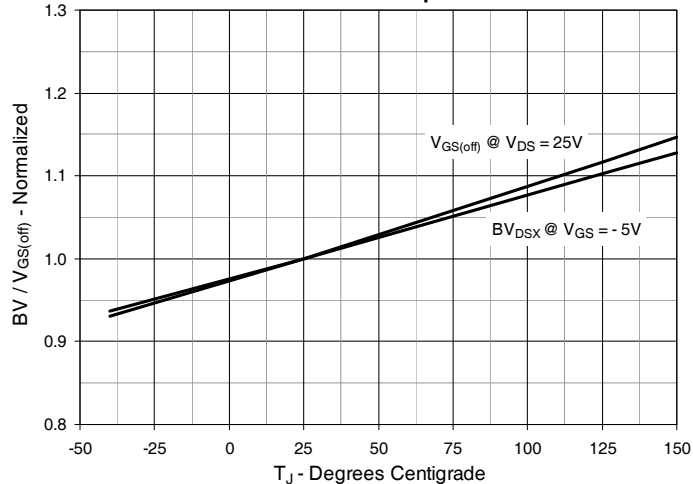

Fig. 12. Forward Voltage Drop of Intrinsic Diode

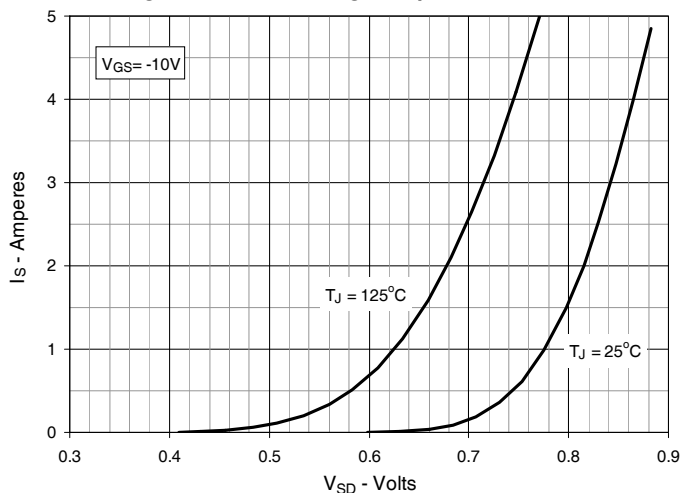

Fig. 13. Capacitance

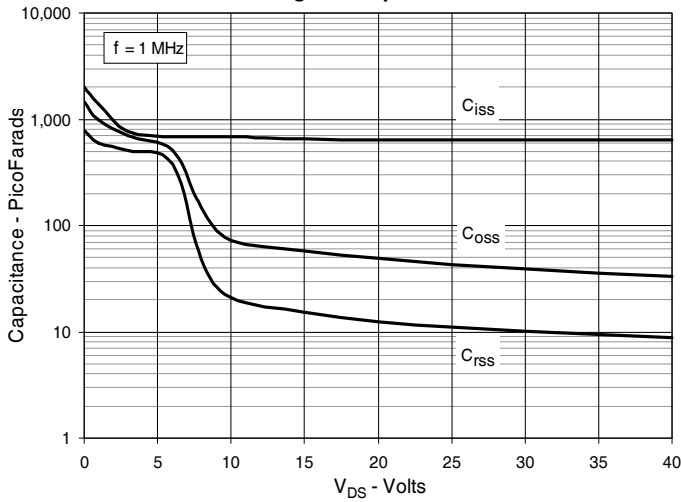

Fig. 14. Gate Charge

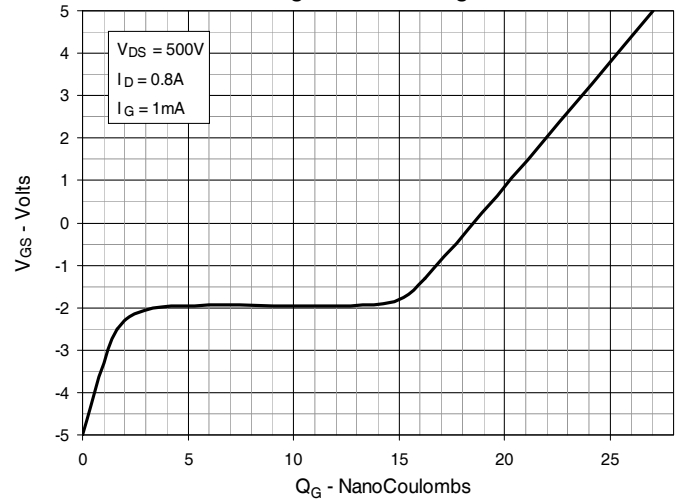

Fig. 15. Forward-Bias Safe Operating Area
@ $T_C = 25^\circ\text{C}$

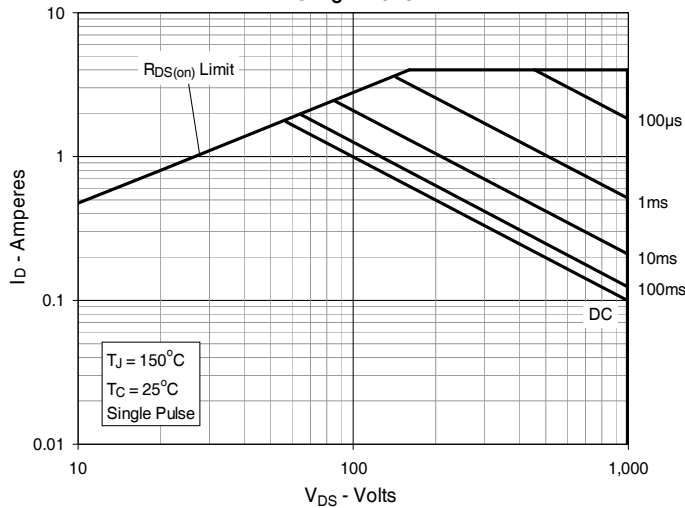

Fig. 16. Forward-Bias Safe Operating Area
@ $T_C = 75^\circ\text{C}$

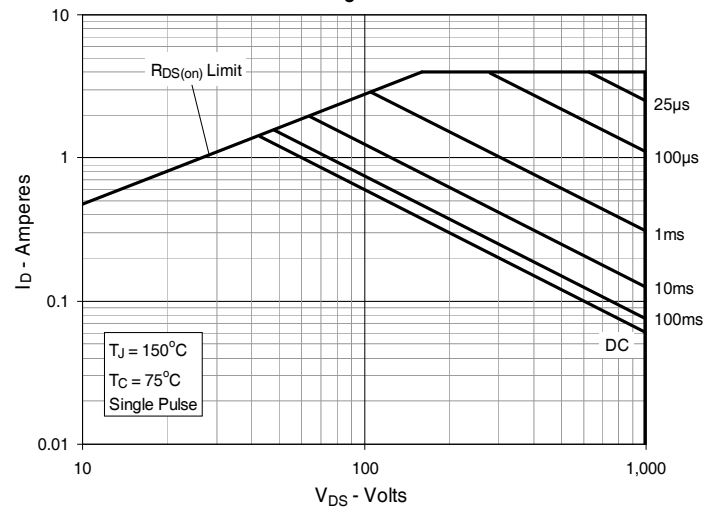
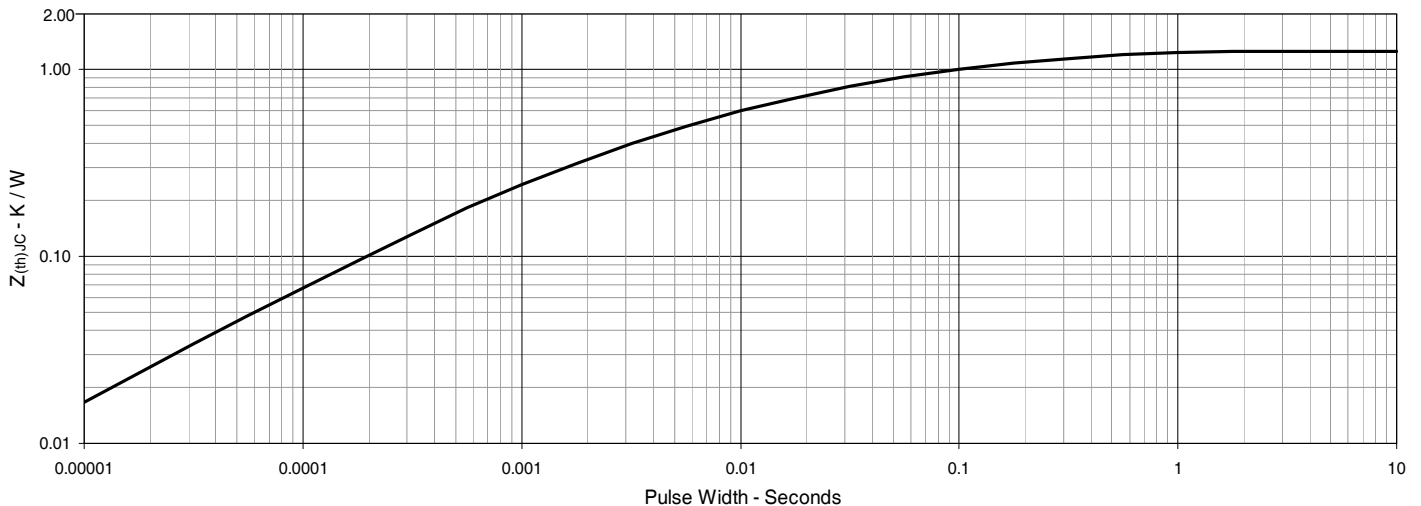
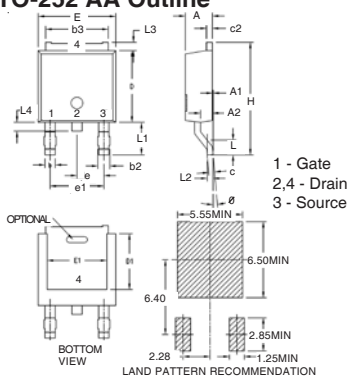

Fig. 17. Maximum Transient Thermal Impedance



TO-252 AA Outline



SYM	INCHES		MILLIMETERS	
	MIN	MAX	MIN	MAX
A	.086	.094	2.19	2.38
A1	0	.005	0	0.12
A2	.038	.046	0.97	1.17
b	.025	.035	0.64	0.89
b2	.030	.045	0.76	1.14
b3	.200	.215	5.08	5.46
c	.018	.024	0.46	0.61
c2	.018	.023	0.46	0.58
D	.235	.245	5.97	6.22
D1	.180	.205	4.57	5.21
E	.250	.265	6.35	6.73
E1	.170	.205	4.32	5.21
e	.090 BSC		2.28 BSC	
e1	.180 BSC		4.57 BSC	
H	.370	.410	9.40	10.42
L	.055	.070	1.40	1.78
L1	.100	.115	2.54	2.92
L2	.020 BSC		0.50 BSC	
L3	.025	.040	0.64	1.02
L4	.025	.040	0.64	1.02
ø	0°	10°	0°	10°

TO-263 Outline

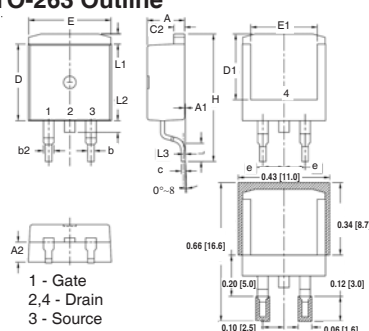

SYM	INCHES		MILLIMETER	
	MIN	MAX	MIN	MAX
A	.170	.185	4.30	4.70
A1	.000	.008	0.00	0.20
A2	.091	.098	2.30	2.50
b	.028	.035	0.70	0.90
b2	.046	.060	1.18	1.52
C	.018	.024	0.45	0.60
C2	.049	.060	1.25	1.52
D	.340	.370	8.63	9.40
D1	.300	.327	7.62	8.30
E	.380	.410	9.65	10.41
E1	.270	.330	6.86	8.38
[e]	.100 BSC		2.54 BSC	
H	.580	.620	14.73	15.75
L	.075	.105	1.91	2.67
L1	.039	.060	1.00	1.52
L2	—	.070	—	1.77
[L3]	.010 BSC		0.254 BSC	

TO-220 Outline

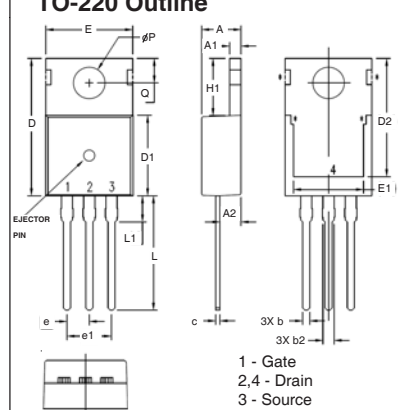

SYM	INCHES		MILLIMETERS	
	MIN	MAX	MIN	MAX
A	.169	.185	4.30	4.70
A1	.047	.055	1.20	1.40
A2	.079	.106	2.00	2.70
b	.024	.039	0.60	1.00
b2	.045	.057	1.15	1.45
c	.014	.026	0.35	0.65
D	.587	.626	14.90	15.90
D1	.335	.370	8.50	9.40
(D2)	.500	.531	12.70	13.50
E	.382	.406	9.70	10.30
(E1)	.283	.323	7.20	8.20
e	.100 BSC		2.54 BSC	
e1	.200 BSC		5.08 BSC	
H1	.244	.268	6.20	6.80
L	.492	.547	12.50	13.90
L1	.110	.154	2.80	3.90
∅P	.134	.150	3.40	3.80
Q	.106	.126	2.70	3.20



Disclaimer Notice - Information furnished is believed to be accurate and reliable. However, users should independently evaluate the suitability of and test each product selected for their own applications. Littelfuse products are not designed for, and may not be used in, all applications. Read complete Disclaimer Notice at www.littelfuse.com/disclaimer-electronics.