

## Depletion Mode MOSFET

**IXTA6N50D2**  
**IXTP6N50D2**  
**IXTH6N50D2**

$V_{DSX} = 500V$   
 $I_{D(on)} \geq 6A$   
 $R_{DS(on)} \leq 550m\Omega$

### N-Channel

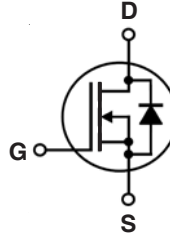

Symbol	Test Conditions	Maximum Ratings	
$V_{DSX}$	$T_J = 25^\circ\text{C to } 150^\circ\text{C}$	500	V
$V_{GSX}$	Continuous	$\pm 20$	V
$V_{GSM}$	Transient	$\pm 30$	V
$P_D$	$T_C = 25^\circ\text{C}$	300	W
$T_J$		- 55 ... +150	$^\circ\text{C}$
$T_{JM}$		150	$^\circ\text{C}$
$T_{stg}$		- 55 ... +150	$^\circ\text{C}$
$T_L$	1.6mm (0.062 in.) from Case for 10s	300	$^\circ\text{C}$
$T_{SOLD}$	Plastic Body for 10s	260	$^\circ\text{C}$
$M_d$	Mounting Torque (TO-220 & TO-247)	1.13 / 10	Nm/lb.in.
Weight	TO-263	2.5	g
	TO-220	3.0	g
	TO-247	6.0	g

Symbol	Test Conditions ( $T_J = 25^\circ\text{C}$ , Unless Otherwise Specified)	Characteristic Values		
		Min.	Typ.	Max.
$BV_{DSX}$	$V_{GS} = -5V, I_D = 250\mu\text{A}$	500		V
$V_{GS(off)}$	$V_{DS} = 25V, I_D = 250\mu\text{A}$	- 2.5		V
$I_{GSX}$	$V_{GS} = \pm 20V, V_{DS} = 0V$			$\pm 100$ nA
$I_{DSX(off)}$	$V_{DS} = V_{DSX}, V_{GS} = -5V$ $T_J = 125^\circ\text{C}$			5 $\mu\text{A}$ 50 $\mu\text{A}$
$R_{DS(on)}$	$V_{GS} = 0V, I_D = 3A, \text{Note 1}$			550 m $\Omega$
$I_{D(on)}$	$V_{GS} = 0V, V_{DS} = 25V, \text{Note 1}$	6		A

#### TO-263 AA (IXTA)

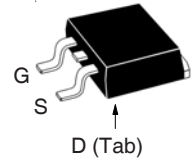

#### TO-220AB (IXTP)

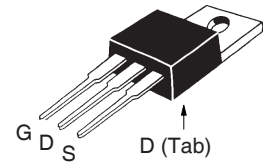

#### TO-247 (IXTH)

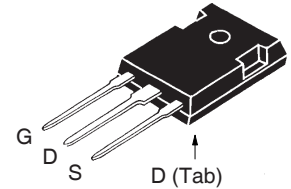

G = Gate      D = Drain  
S = Source    Tab = Drain

#### Features

- Normally ON Mode
- International Standard Packages
- Molding Epoxies Meet UL 94 V-0 Flammability Classification

#### Advantages

- Easy to Mount
- Space Savings
- High Power Density

#### Applications

- Audio Amplifiers
- Start-up Circuits
- Protection Circuits
- Ramp Generators
- Current Regulators
- Active Loads

Symbol	Test Conditions ( $T_J = 25^\circ\text{C}$ , Unless Otherwise Specified)	Characteristic Values		
		Min.	Typ.	Max.
$g_{fs}$	$V_{DS} = 30\text{V}, I_D = 3\text{A}$ , Note 1	2.8	4.5	S
$C_{iss}$	$V_{GS} = -10\text{V}, V_{DS} = 25\text{V}, f = 1\text{MHz}$		2800	pF
$C_{oss}$			255	pF
$C_{rss}$			64	pF
$t_{d(on)}$	<b>Resistive Switching Times</b> $V_{GS} = \pm 5\text{V}, V_{DS} = 250\text{V}, I_D = 3\text{A}$ $R_G = 2.4\Omega$ (External)		28	ns
$t_r$			72	ns
$t_{d(off)}$			82	ns
$t_f$			43	ns
$Q_{g(on)}$	$V_{GS} = \pm 5\text{V}, V_{DS} = 250\text{V}, I_D = 3\text{A}$		96	nC
$Q_{gs}$			11	nC
$Q_{gd}$			48	nC
$R_{thJC}$	TO-220 TO-247		0.50	$^\circ\text{C/W}$
$R_{thCS}$			0.21	$^\circ\text{C/W}$

### Safe-Operating-Area Specification

Symbol	Test Conditions	Characteristic Values		
		Min.	Typ.	Max.
SOA	$V_{DS} = 400\text{V}, I_D = 0.45\text{A}, T_C = 75^\circ\text{C}, T_p = 5\text{s}$	180		W

### Source-Drain Diode

Symbol	Test Conditions ( $T_J = 25^\circ\text{C}$ , Unless Otherwise Specified)	Characteristic Values		
		Min.	Typ.	Max.
$V_{SD}$	$I_F = 6\text{A}, V_{GS} = -10\text{V}$ , Note 1		0.8	1.3 V
$t_{rr}$	$I_F = 3\text{A}, -di/dt = 100\text{A}/\mu\text{s}$ $V_R = 100\text{V}, V_{GS} = -10\text{V}$		350	ns
$I_{RM}$			16	A
$Q_{RM}$			2.8	$\mu\text{C}$

Note 1. Pulse test,  $t \leq 300\mu\text{s}$ , duty cycle,  $d \leq 2\%$ .

### TO-263 Outline

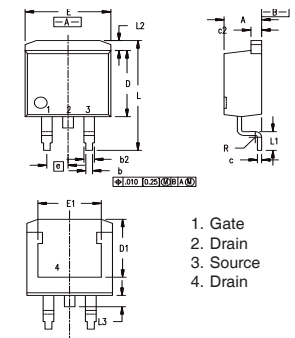

1. Gate  
2. Drain  
3. Source  
4. Drain

Dim.	Millimeter		Inches	
	Min.	Max.	Min.	Max.
A	4.06	4.83	.160	.190
b	0.51	0.99	.020	.039
b2	1.14	1.40	.045	.055
c	0.40	0.74	.016	.029
c2	1.14	1.40	.045	.055
D	8.64	9.65	.340	.380
D1	8.00	8.89	.280	.320
E	9.65	10.41	.380	.405
E1	6.22	8.13	.270	.320
e	2.54	BSC	.100	BSC
L	14.61	15.88	.575	.625
L1	2.29	2.79	.090	.110
L2	1.02	1.40	.040	.055
L3	1.27	1.78	.050	.070

### TO-220 Outline

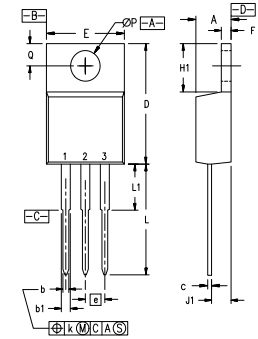

Pins: 1 - Gate  
2 - Drain  
3 - Source

SYM	INCHES		MILLIMETERS	
	MIN	MAX	MIN	MAX
A	.170	.190	4.32	4.83
b	.025	.040	0.64	1.02
b1	.045	.065	1.15	1.65
c	.014	.022	0.35	0.56
D	.580	.630	14.73	16.00
E	.390	.420	9.91	10.66
e	.100 BSC		2.54 BSC	
F	.045	.055	1.14	1.40
H1	.230	.270	5.85	6.85
J1	.090	.110	2.29	2.79
k	0	.015	0	0.38
L	.500	.550	12.70	13.97
L1	.110	.230	2.79	5.84
$\varnothing P$	.139	.161	3.53	4.08
Q	.100	.125	2.54	3.18

### TO-247 Outline

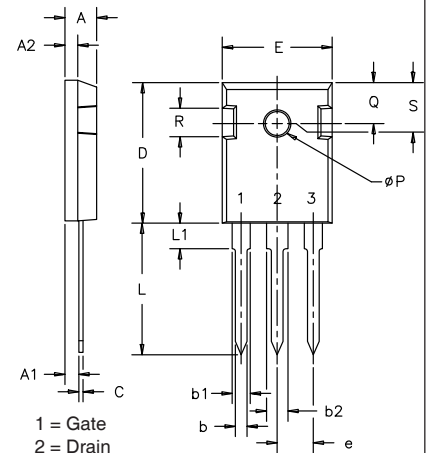

SYM	INCHES		MILLIMETERS	
	MIN	MAX	MIN	MAX
A	.185	.209	4.7	5.3
A1	.087	.102	2.2	2.54
A2	.059	.098	2.2	2.6
b	.040	.055	1.0	1.4
b1	.065	.084	1.65	2.13
b2	.113	.123	2.87	3.12
C	.016	.031	.4	.8
D	.819	.845	20.80	21.46
E	.610	.640	15.75	16.26
e	.215 BSC		5.45 BSC	
L	.780	.800	19.81	20.32
L1		.177		4.50
$\varnothing P$	.140	.144	3.55	3.65
Q	.212	.244	5.4	6.2
R	.170	.216	4.32	5.49
S	.242 BSC		6.15 BSC	

IXYS Reserves the Right to Change Limits, Test Conditions, and Dimensions.

IXYS MOSFETs and IGBTs are covered by one or more of the following U.S. patents:	4,835,592	4,931,844	5,049,961	5,237,481	6,162,665	6,404,065 B1	6,683,344	6,727,585	7,005,734 B2	7,157,338B2
	4,850,072	5,017,508	5,063,307	5,381,025	6,259,123 B1	6,534,343	6,710,405 B2	6,759,692	7,063,975 B2	
	4,881,106	5,034,796	5,187,117	5,486,715	6,306,728 B1	6,583,505	6,710,463	6,771,478 B2	7,071,537	

Fig. 1. Output Characteristics @  $T_J = 25^\circ\text{C}$

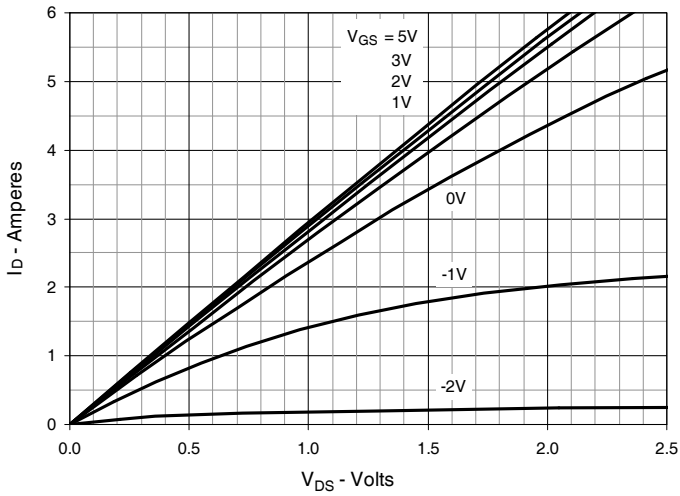

Fig. 2. Extended Output Characteristics @  $T_J = 25^\circ\text{C}$

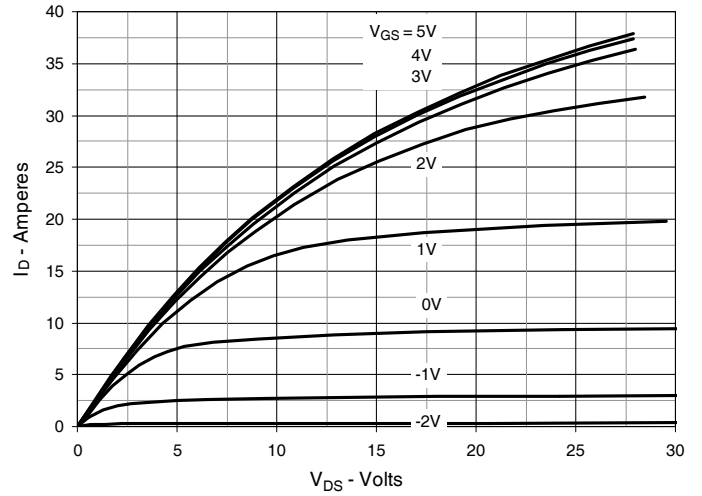

Fig. 3. Output Characteristics @  $T_J = 125^\circ\text{C}$

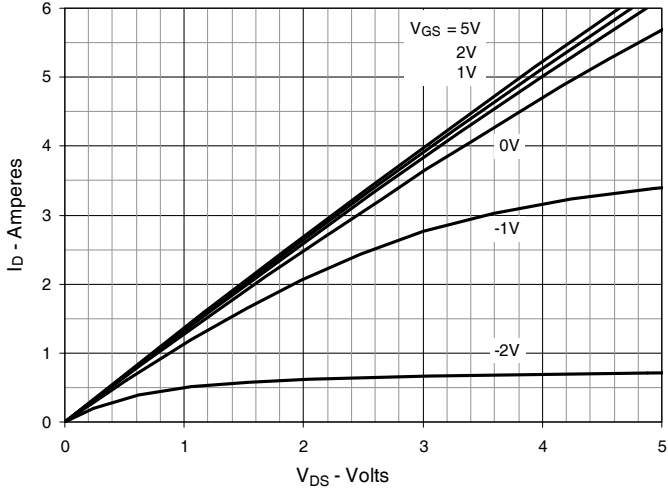

Fig. 4. Drain Current @  $T_J = 25^\circ\text{C}$

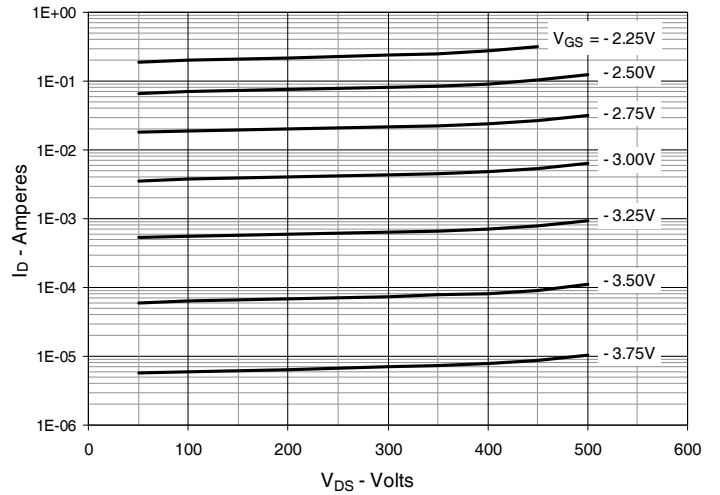

Fig. 5. Drain Current @  $T_J = 100^\circ\text{C}$

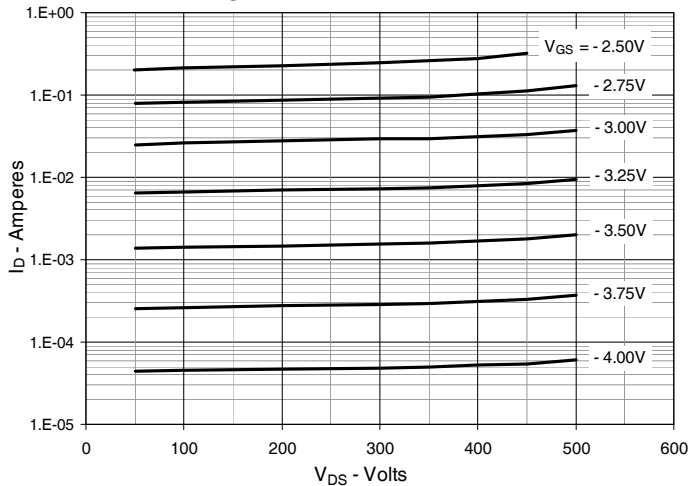

Fig. 6. Dynamic Output Resistance vs. Gate Voltage

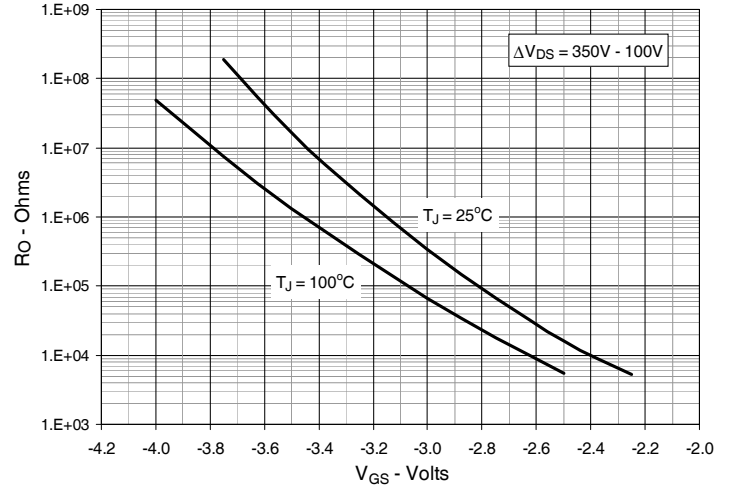

Fig. 7. Normalized  $R_{DS(on)}$  vs. Junction Temperature

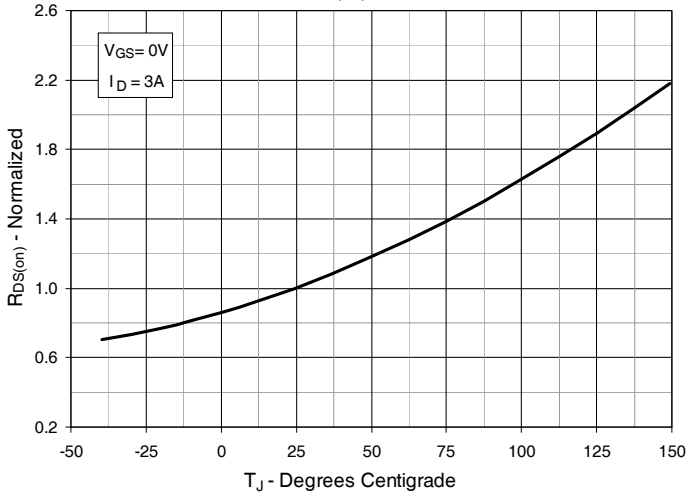

Fig. 8.  $R_{DS(on)}$  Normalized to  $I_D = 3A$  Value vs. Drain Current

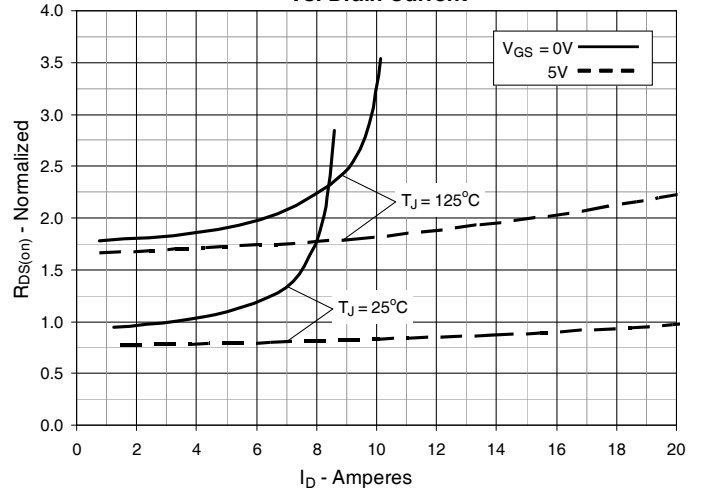

Fig. 9. Input Admittance

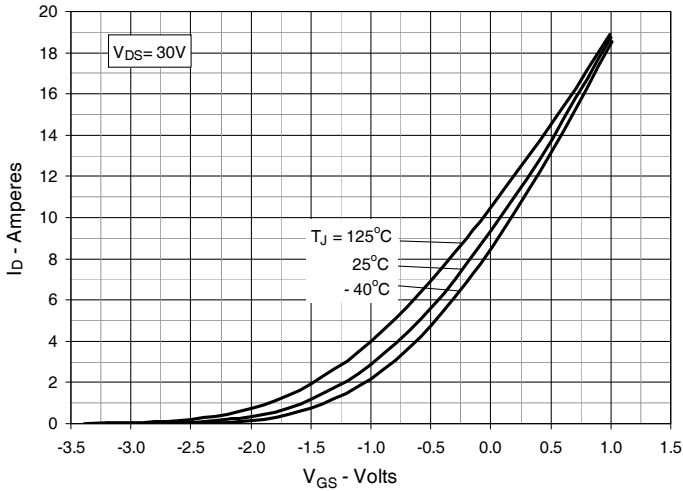

Fig. 10. Transconductance

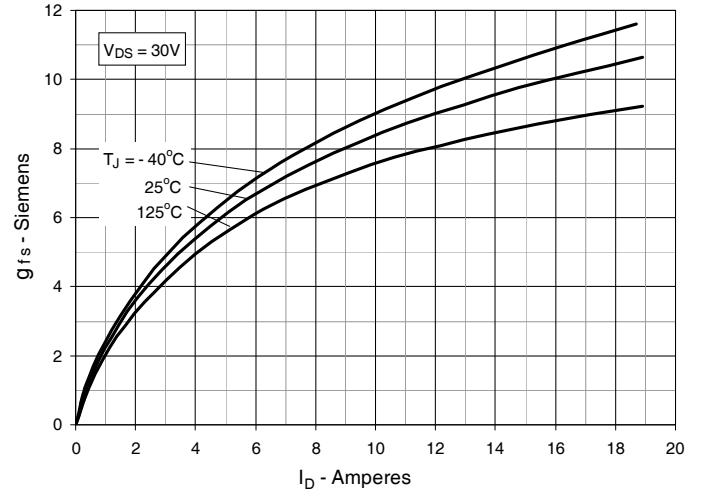

Fig. 11. Breakdown and Threshold Voltages vs. Junction Temperature

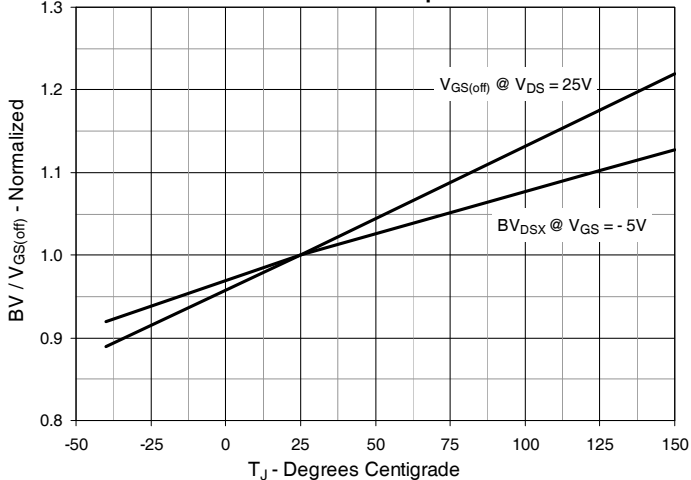

Fig. 12. Forward Voltage Drop of Intrinsic Diode

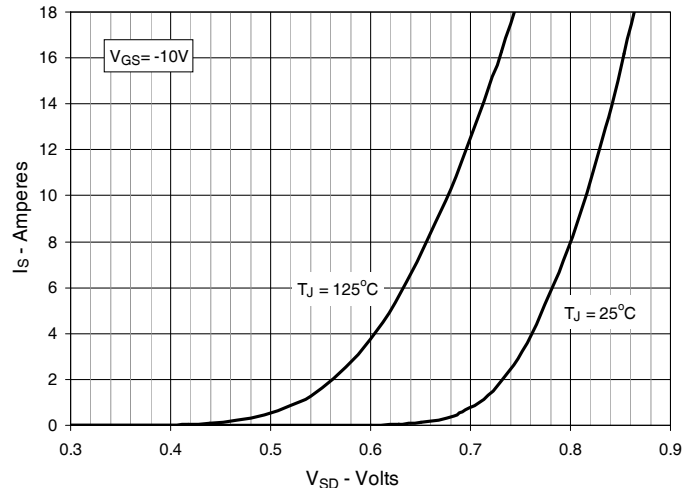

Fig. 13. Capacitance

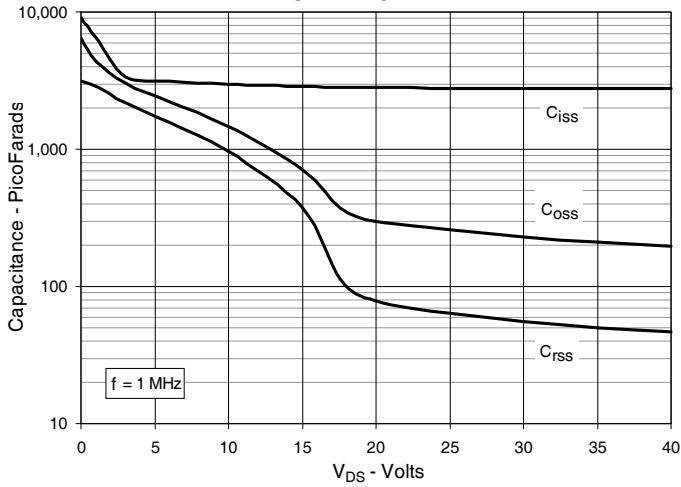

Fig. 14. Gate Charge

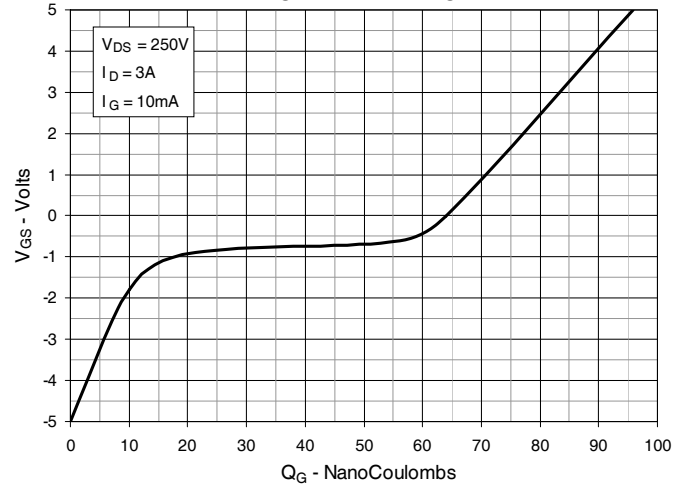

Fig. 15. Forward-Bias Safe Operating Area  
@ T<sub>C</sub> = 25°C

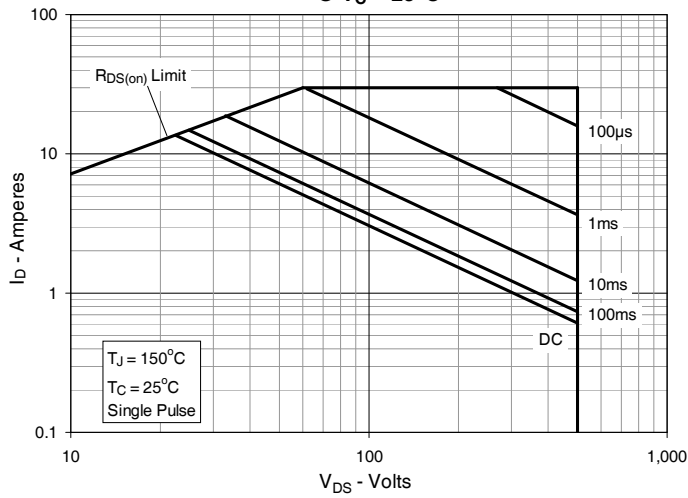

Fig. 16. Forward-Bias Safe Operating Area  
@ T<sub>C</sub> = 75°C

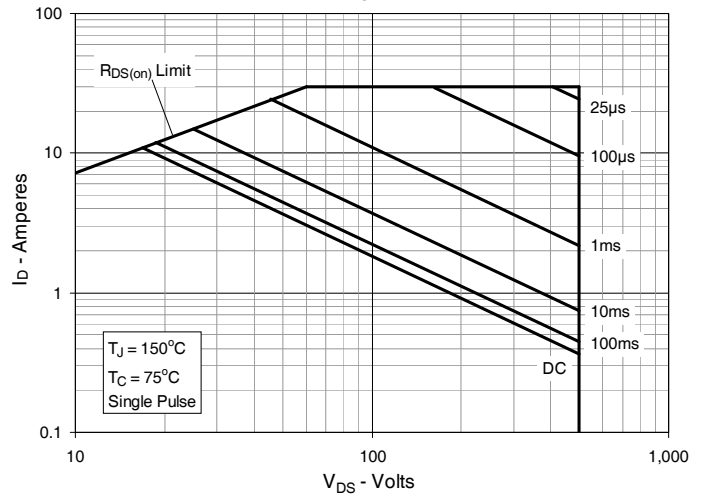
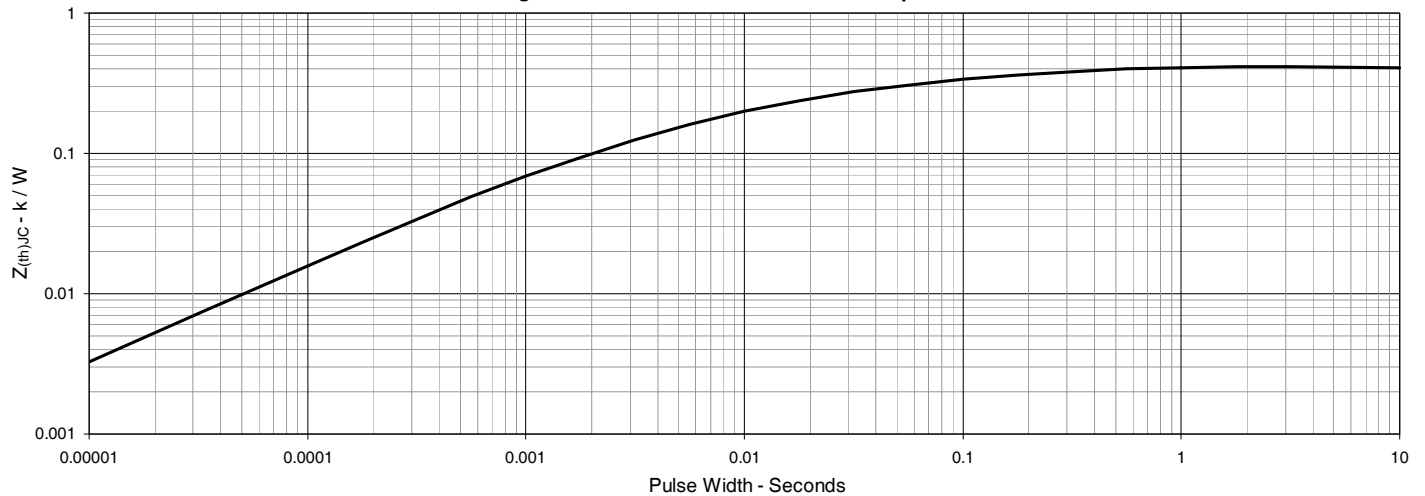

Fig. 17. Maximum Transient Thermal Impedance





---

Disclaimer Notice - Information furnished is believed to be accurate and reliable. However, users should independently evaluate the suitability of and test each product selected for their own applications. Littelfuse products are not designed for, and may not be used in, all applications. Read complete Disclaimer Notice at [www.littelfuse.com/disclaimer-electronics](http://www.littelfuse.com/disclaimer-electronics).