

**Polar™ HiPerFET™**  
**Power MOSFET**

**IXFH120N20P**  
**IXFK120N20P**

$V_{DSS} = 200V$   
 $I_{D25} = 120A$   
 $R_{DS(on)} \leq 22m\Omega$   
 $t_{rr} \leq 200ns$

N-Channel Enhancement Mode  
Avalanche Rated  
Fast Intrinsic Diode



Symbol	Test Conditions	Maximum Ratings	
$V_{DSS}$	$T_J = 25^\circ C$ to $175^\circ C$	200	V
$V_{DGR}$	$T_J = 25^\circ C$ to $175^\circ C$ , $R_{GS} = 1M\Omega$	200	V
$V_{GSS}$	Continuous	$\pm 20$	V
$V_{GSM}$	Transient	$\pm 30$	V
$I_{D25}$	$T_C = 25^\circ C$	120	A
$I_{LRMS}$	Lead Current Limit, RMS	75	A
$I_{DM}$	$T_C = 25^\circ C$ , Pulse Width Limited by $T_{JM}$	300	A
$I_A$	$T_C = 25^\circ C$	60	A
$E_{AS}$	$T_C = 25^\circ C$	2	J
$P_D$	$T_C = 25^\circ C$	714	W
$dV/dt$	$I_S \leq I_{DM}$ , $V_{DD} \leq V_{DSS}$ , $T_J \leq 175^\circ C$	10	V/ns
$T_J$		-55 ... +175	$^\circ C$
$T_{JM}$		175	$^\circ C$
$T_{stg}$		-55 ... +175	$^\circ C$
$T_L$	1.6mm (0.062 in.) from Case for 10s	300	$^\circ C$
$T_{SOLD}$	Plastic Body for 10s	260	$^\circ C$
$M_d$	Mounting Torque	1.13/10	Nm/lb.in.
<b>Weight</b>	TO-247	6	g
	TO-264	10	g

TO-247 (IXFH)

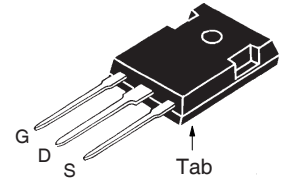

TO-264 (IXFK)

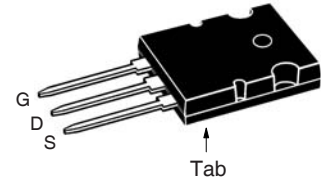

G = Gate      D = Drain  
S = Source    Tab = Drain

**Features**

- International Standard Packages
- Avalanche Rated
- Fast Intrinsic Diode
- Low  $Q_G$
- Low  $R_{DS(on)}$
- Low Drain-to-Tab Capacitance
- Low Package Inductance

**Advantages**

- Easy to Mount
- Space Savings

**Applications**

- DC-DC Converters
- Battery Chargers
- Switch-Mode and Resonant-Mode Power Supplies
- DC Choppers
- AC and DC Motor Drives
- Uninterrupted Power Supplies
- High Speed Power Switching Applications

Symbol	Test Conditions ( $T_J = 25^\circ C$ Unless Otherwise Specified)	Characteristic Values		
		Min.	Typ.	Max.
$BV_{DSS}$	$V_{GS} = 0V$ , $I_D = 250\mu A$	200		V
$V_{GS(th)}$	$V_{DS} = V_{GS}$ , $I_D = 4mA$	2.5		5.0 V
$I_{GSS}$	$V_{GS} = \pm 20V$ , $V_{DS} = 0V$			$\pm 200$ nA
$I_{DSS}$	$V_{DS} = V_{DSS}$ , $V_{GS} = 0V$ $T_J = 150^\circ C$			25 $\mu A$ 500 $\mu A$
$R_{DS(on)}$	$V_{GS} = 10V$ , $I_D = 0.5 \cdot I_{D25}$ , Note 1			22 $m\Omega$

Symbol	Test Conditions ( $T_J = 25^\circ\text{C}$ Unless Otherwise Specified)	Characteristic Values		
		Min.	Typ.	Max.
$g_{fs}$	$V_{DS} = 10\text{V}, I_D = 0.5 \cdot I_{D25}$ , Note 1	40	63	S
$C_{iss}$	$V_{GS} = 0\text{V}, V_{DS} = 25\text{V}, f = 1\text{MHz}$		6000	pF
$C_{oss}$			1300	pF
$C_{rss}$			265	pF
$t_{d(on)}$	<b>Resistive Switching Times</b> $V_{GS} = 10\text{V}, V_{DS} = 0.5 \cdot V_{DSS}, I_D = 0.5 \cdot I_{D25}$ $R_G = 3.3\Omega$ (External)		30	ns
$t_r$			35	ns
$t_{d(off)}$			100	ns
$t_f$			31	ns
$Q_{g(on)}$	$V_{GS} = 10\text{V}, V_{DS} = 0.5 \cdot V_{DSS}, I_D = 0.5 \cdot I_{D25}$		152	nC
$Q_{gs}$			40	nC
$Q_{gd}$			75	nC
$R_{thJC}$				0.21 $^\circ\text{C/W}$
$R_{thCS}$	TO-247		0.21	$^\circ\text{C/W}$
	TO-264		0.15	$^\circ\text{C/W}$

### Source-Drain Diode

Symbol	Test Conditions ( $T_J = 25^\circ\text{C}$ , Unless Otherwise Specified)	Characteristic Values		
		Min.	Typ.	Max.
$I_S$	$V_{GS} = 0\text{V}$			120 A
$I_{SM}$	Repetitive, Pulse Width Limited by $T_{JM}$			300 A
$V_{SD}$	$I_F = I_S, V_{GS} = 0\text{V}$ , Note 1			1.5 V
$t_{rr}$	$I_F = 25\text{A}, -di/dt = 100\text{A}/\mu\text{s}$ $V_R = 100\text{V}, V_{GS} = 0\text{V}$		100	200 ns
$Q_{RM}$			0.4	$\mu\text{C}$
$I_{RM}$			6.0	A

Note 1. Pulse test,  $t \leq 300\mu\text{s}$ , duty cycle,  $d \leq 2\%$ .

IXYS Reserves the Right to Change Limits, Test Conditions, and Dimensions.

IXYS MOSFETs and IGBTs are covered by one or more of the following U.S. patents:	4,835,592	4,931,844	5,049,961	5,237,481	6,162,665	6,404,065 B1	6,683,344	6,727,585	7,005,734 B2	7,157,338B2
	4,850,072	5,017,508	5,063,307	5,381,025	6,259,123 B1	6,534,343	6,710,405 B2	6,759,692	7,063,975 B2	
	4,881,106	5,034,796	5,187,117	5,486,715	6,306,728 B1	6,583,505	6,710,463	6,771,478 B2	7,071,537	

### TO-247 (IXFH) Outline

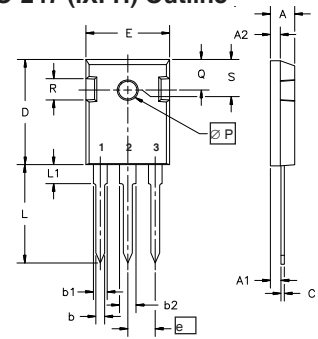

Terminals: 1 - Gate  
2 - Drain  
3 - Source

Dim.	Millimeter		Inches	
	Min.	Max.	Min.	Max.
A	4.7	5.3	.185	.209
A <sub>1</sub>	2.2	2.54	.087	.102
A <sub>2</sub>	2.2	2.6	.059	.098
b	1.0	1.4	.040	.055
b <sub>1</sub>	1.65	2.13	.065	.084
b <sub>2</sub>	2.87	3.12	.113	.123
C	.4	.8	.016	.031
D	20.80	21.46	.819	.845
E	15.75	16.26	.610	.640
e	5.20	5.72	0.205	0.225
L	19.81	20.32	.780	.800
L1		4.50		.177
∅P	3.55	3.65	.140	.144
Q	5.89	6.40	0.232	0.252
R	4.32	5.49	.170	.216
S	6.15	BSC	.242	BSC

### TO-264 (IXFK) Outline

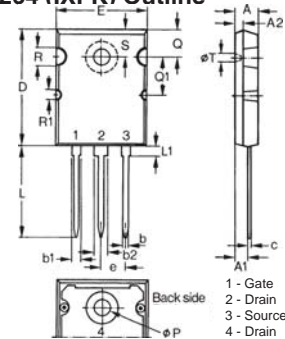

1 - Gate  
2 - Drain  
3 - Source  
4 - Drain

Dim.	Millimeter		Inches	
	Min.	Max.	Min.	Max.
A	4.82	5.13	.190	.202
A1	2.54	2.89	.100	.114
A2	2.00	2.10	.079	.083
b	1.12	1.42	.044	.056
b1	2.39	2.69	.094	.106
b2	2.90	3.09	.114	.122
c	0.53	0.83	.021	.033
D	25.91	26.16	1.020	1.030
E	19.81	19.96	.780	.786
e		5.46 BSC		.215 BSC
J	0.00	0.25	.000	.010
K	0.00	0.25	.000	.010
L	20.32	20.83	.800	.820
L1	2.29	2.59	.090	.102
P	3.17	3.66	.125	.144
Q	6.07	6.27	.239	.247
Q1	8.38	8.69	.330	.342
R	3.81	4.32	.150	.170
R1	1.78	2.29	.070	.090
S	6.04	6.30	.238	.248
T	1.57	1.83	.062	.072

**Fig. 1. Output Characteristics @ 25°C**

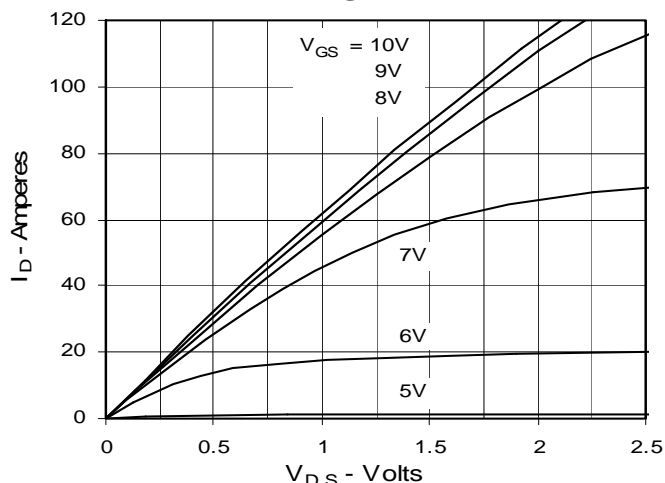

**Fig. 2. Extended Output Characteristics @ 25°C**

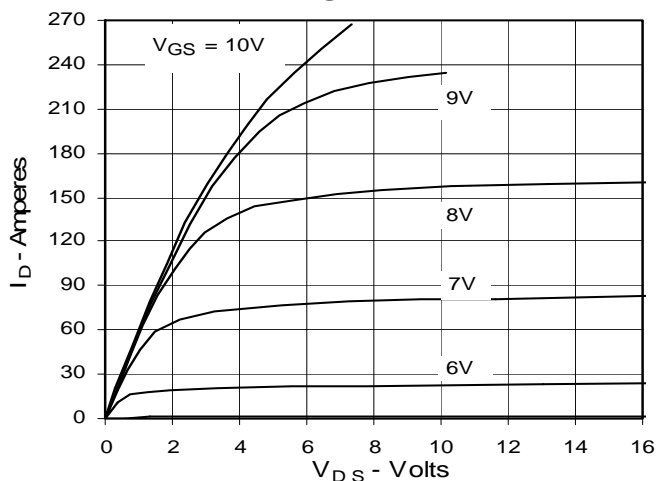

**Fig. 3. Output Characteristics @ 150°C**

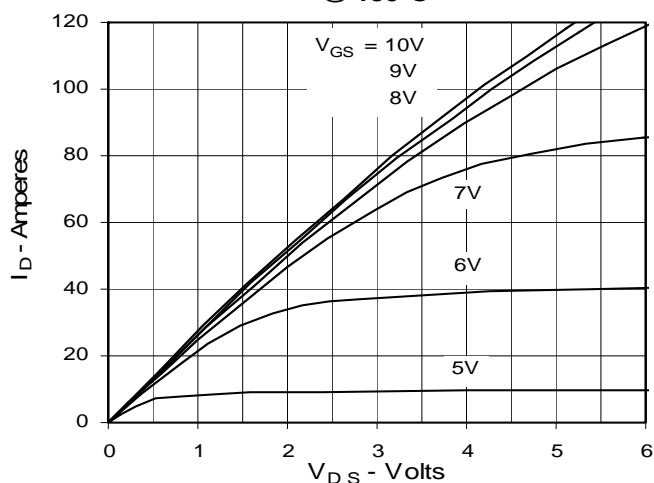

**Fig. 4.  $R_{DS(on)}$  Normalized to 0.5  $I_{D25}$  Value vs. Junction Temperature**

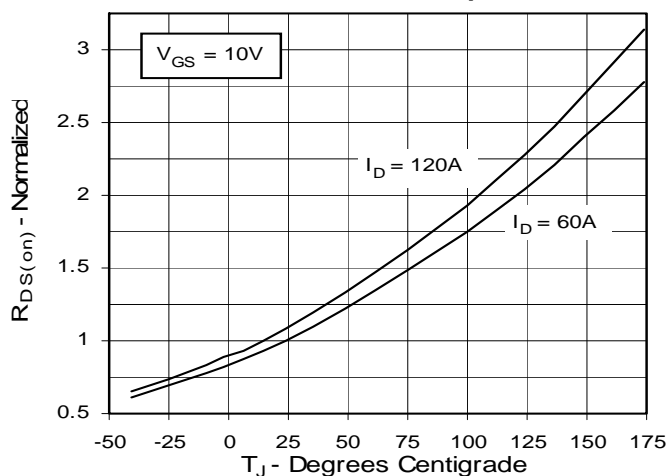

**Fig. 5.  $R_{DS(on)}$  Normalized to 0.5  $I_{D25}$  Value vs. Drain Current**

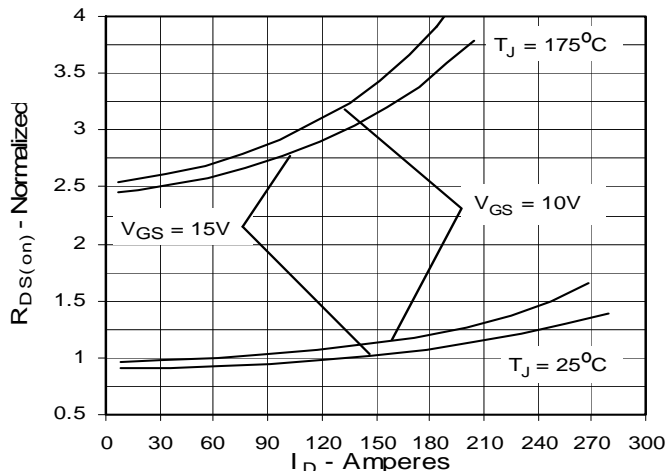

**Fig. 6. Drain Current vs. Case Temperature**

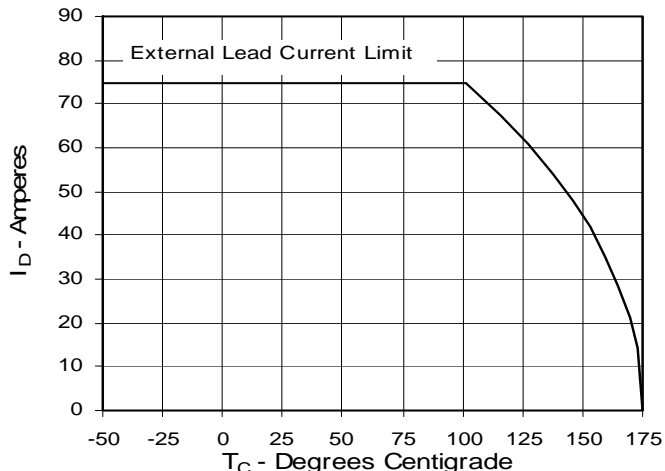

**Fig. 7. Input Admittance**

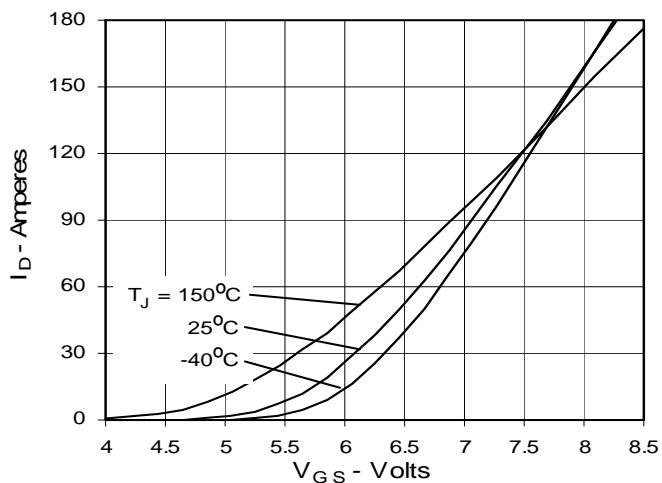

**Fig. 8. Transconductance**

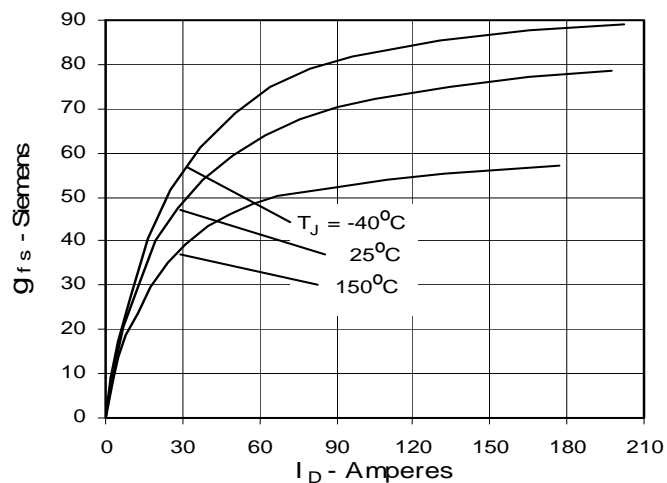

**Fig. 9. Source Current vs. Source-To-Drain Voltage**

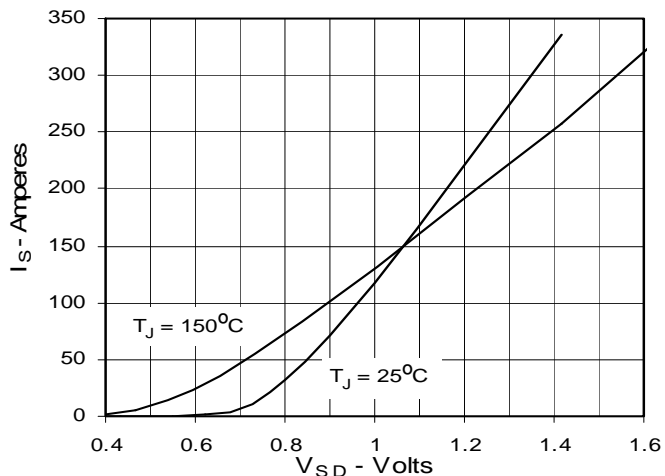

**Fig. 10. Gate Charge**

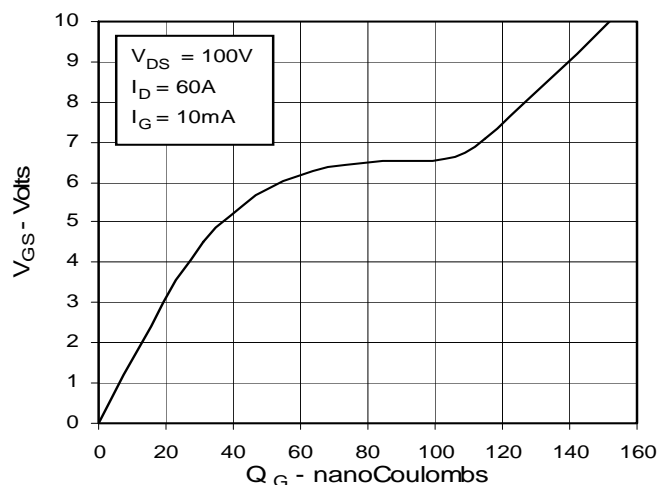

**Fig. 11. Capacitance**

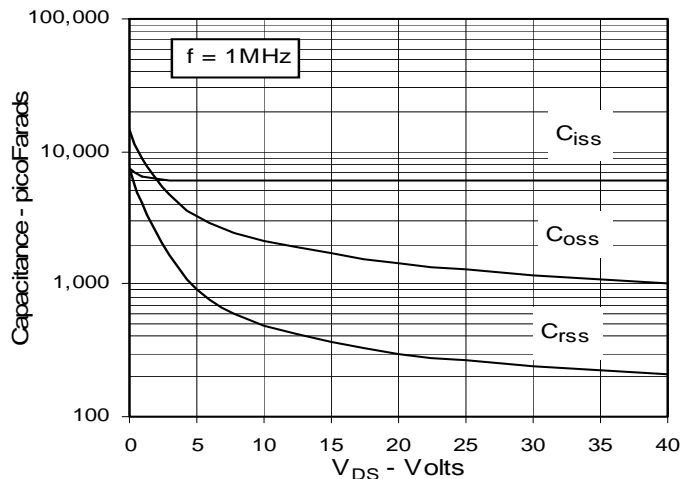

**Fig. 12. Forward-Bias Safe Operating Area**

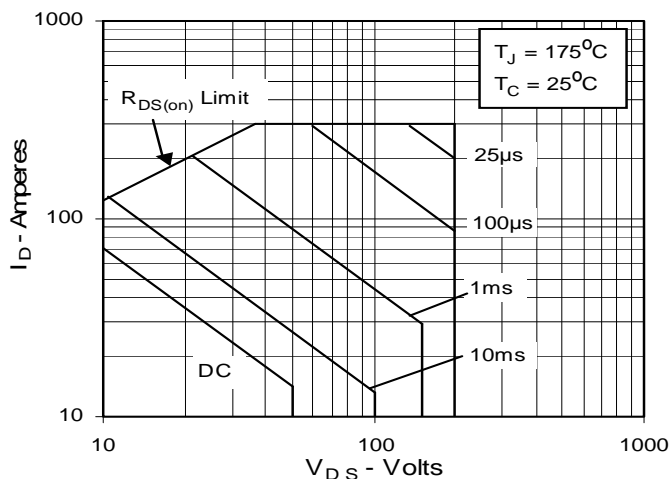
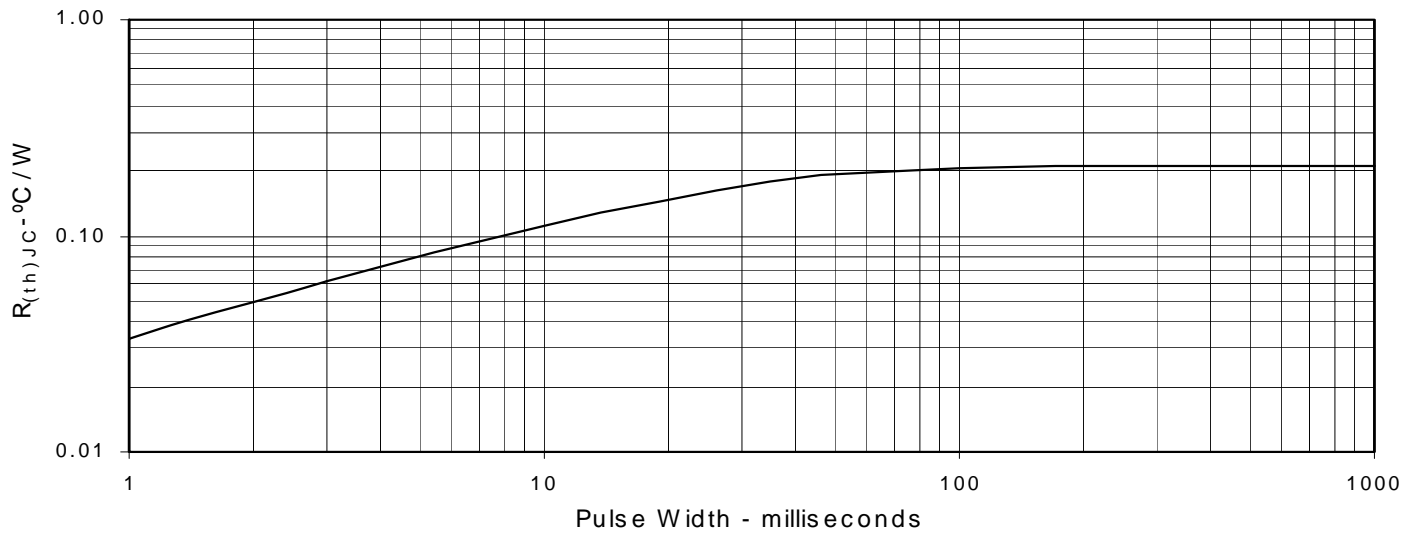

Fig. 13. Maximum Transient Thermal Resistance





---

Disclaimer Notice - Information furnished is believed to be accurate and reliable. However, users should independently evaluate the suitability of and test each product selected for their own applications. Littelfuse products are not designed for, and may not be used in, all applications. Read complete Disclaimer Notice at [www.littelfuse.com/disclaimer-electronics](http://www.littelfuse.com/disclaimer-electronics).