

Polar3™ HiPerFET™
Power MOSFET

IXFK120N30P3
IXFX120N30P3

N-Channel Enhancement Mode
Avalanche Rated
Fast Intrinsic Diode

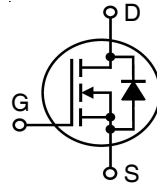

$V_{DSS} = 300V$
 $I_{D25} = 120A$
 $R_{DS(on)} \leq 27m\Omega$
 $t_{rr} \leq 250ns$

Symbol	Test Conditions	Maximum Ratings	
V_{DSS}	$T_J = 25^\circ C$ to $150^\circ C$	300	V
V_{DGR}	$T_J = 25^\circ C$ to $150^\circ C$, $R_{GS} = 1M\Omega$	300	V
V_{GSS}	Continuous	± 20	V
V_{GSM}	Transient	± 30	V
I_{D25}	$T_C = 25^\circ C$	120	A
I_{DM}	$T_C = 25^\circ C$, Pulse Width Limited by T_{JM}	300	A
I_A	$T_C = 25^\circ C$	60	A
E_{AS}	$T_C = 25^\circ C$	3	J
P_D	$T_C = 25^\circ C$	1130	W
dv/dt	$I_S \leq I_{DM}$, $V_{DD} \leq V_{DSS}$, $T_J \leq 150^\circ C$	35	V/ns
T_J		-55 ... +150	$^\circ C$
T_{JM}		150	$^\circ C$
T_{stg}		-55 ... +150	$^\circ C$
T_L	Maximum Lead Temperature for Soldering	300	$^\circ C$
T_{SOLD}	Plastic Body for 10s	260	$^\circ C$
M_d	Mounting Torque (TO-264)	1.13/10	Nm/lb.in
F_C	Mounting Force (PLUS247)	20..120 / 4.5..27	N/lb
Weight	TO-264	10	g
	PLUS247	6	g

TO-264
(IXFK)

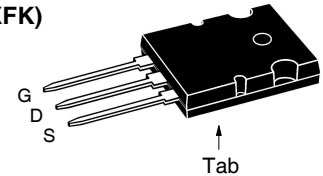

PLUS247
(IXFX)

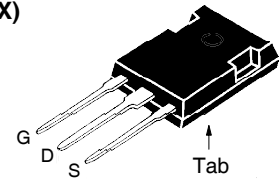

G = Gate D = Drain
S = Source Tab = Drain

Features

- Dynamic dv/dt Rating
- Avalanche Rated
- Fast Intrinsic Diode
- Low Q_G
- Low $R_{DS(on)}$
- Low Drain-to-Tab Capacitance
- Low Package Inductance

Advantages

- Easy to Mount
- Space Savings

Applications

- DC-DC Converters
- Battery Chargers
- Switch-Mode and Resonant-Mode Power Supplies
- Uninterrupted Power Supplies
- AC Motor Drives
- High Speed Power Switching Applications

Symbol	Test Conditions ($T_J = 25^\circ C$ Unless Otherwise Specified)	Characteristic Values		
		Min.	Typ.	Max.
BV_{DSS}	$V_{GS} = 0V$, $I_D = 1mA$	300		V
$V_{GS(th)}$	$V_{DS} = V_{GS}$, $I_D = 4mA$	3.0		5.0 V
I_{GSS}	$V_{GS} = \pm 20V$, $V_{DS} = 0V$			± 200 nA
I_{DSS}	$V_{DS} = V_{DSS}$, $V_{GS} = 0V$ $T_J = 125^\circ C$			25 μA 750 μA
$R_{DS(on)}$	$V_{GS} = 10V$, $I_D = 0.5 \cdot I_{D25}$, Note 1			27 m Ω

Symbol	Test Conditions ($T_J = 25^\circ\text{C}$ Unless Otherwise Specified)	Characteristic Values		
		Min.	Typ.	Max.
g_{fs}	$V_{DS} = 10\text{V}, I_D = 0.5 \cdot I_{D25}$, Note 1	54	90	S
C_{iss}	$V_{GS} = 0\text{V}, V_{DS} = 25\text{V}, f = 1\text{MHz}$		8630	pF
C_{oss}			1406	pF
C_{rss}			20	pF
R_{Gi}	Gate Input Resistance		1.5	Ω
$t_{d(on)}$	Resistive Switching Times $V_{GS} = 10\text{V}, V_{DS} = 0.5 \cdot V_{DSS}, I_D = 0.5 \cdot I_{D25}$ $R_G = 1\Omega$ (External)		26	ns
t_r			13	ns
$t_{d(off)}$			60	ns
t_f			11	ns
$Q_{g(on)}$	$V_{GS} = 10\text{V}, V_{DS} = 0.5 \cdot V_{DSS}, I_D = 0.5 \cdot I_{D25}$		150	nC
Q_{gs}			40	nC
Q_{gd}			53	nC
R_{thJC}				0.11 $^\circ\text{C/W}$
R_{thCS}		0.15		$^\circ\text{C/W}$

Source-Drain Diode

Symbol	Test Conditions ($T_J = 25^\circ\text{C}$, Unless Otherwise Specified)	Characteristic Values		
		Min.	Typ.	Max.
I_S	$V_{GS} = 0\text{V}$			120 A
I_{SM}	Repetitive, Pulse Width Limited by T_{JM}			480 A
V_{SD}	$I_F = I_S, V_{GS} = 0\text{V}$, Note 1			1.5 V
t_{rr}	$I_F = 60\text{A}, -di/dt = 100\text{A}/\mu\text{s}$ $V_R = 100\text{V}, V_{GS} = 0\text{V}$			250 ns
Q_{RM}			2.2	μC
I_{RM}			19.6	A

Note 1. Pulse test, $t \leq 300\mu\text{s}$, duty cycle, $d \leq 2\%$.

IXYS Reserves the Right to Change Limits, Test Conditions, and Dimensions.

IXYS MOSFETs and IGBTs are covered by one or more of the following U.S. patents:

4,835,592	4,931,844	5,049,961	5,237,481	6,162,665	6,404,065 B1	6,683,344	6,727,585	7,005,734 B2	7,157,338B2
4,860,072	5,017,508	5,063,307	5,381,025	6,259,123 B1	6,534,343	6,710,405 B2	6,759,692	7,063,975 B2	
4,881,106	5,034,796	5,187,117	5,486,715	6,306,728 B1	6,583,505	6,710,463	6,771,478 B2	7,071,537	

Fig. 1. Output Characteristics @ $T_J = 25^\circ\text{C}$

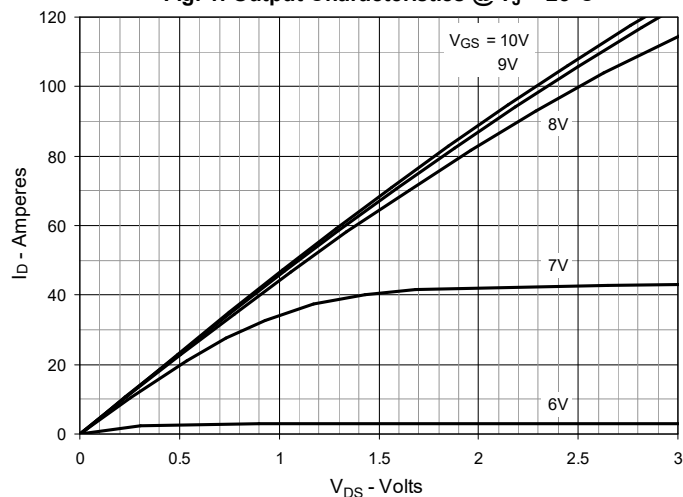

Fig. 2. Extended Output Characteristics @ $T_J = 25^\circ\text{C}$

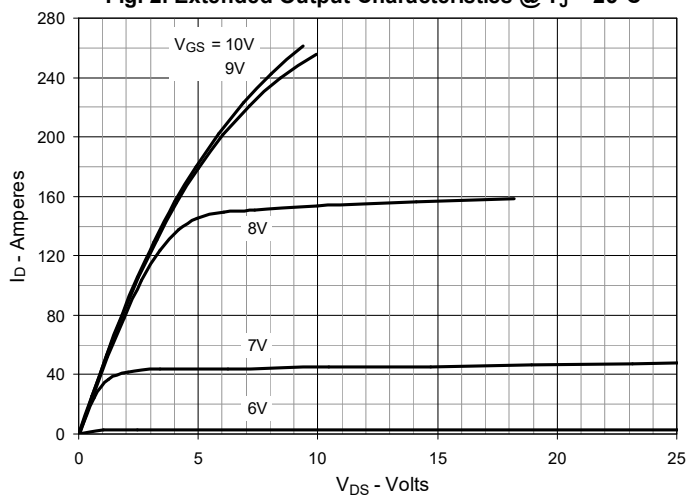

Fig. 3. Output Characteristics @ $T_J = 125^\circ\text{C}$

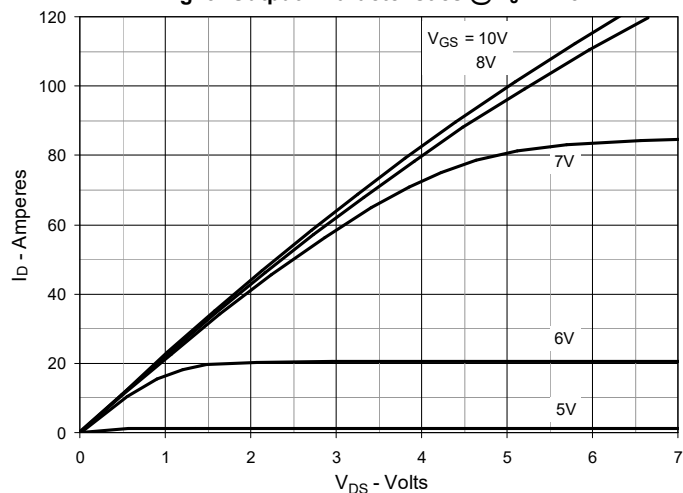

Fig. 4. $R_{DS(on)}$ Normalized to $I_D = 60A$ Value vs. Junction Temperature

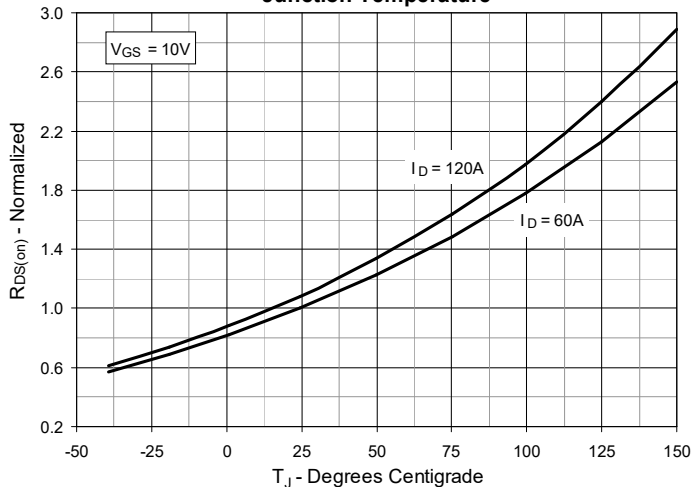

Fig. 5. $R_{DS(on)}$ Normalized to $I_D = 60A$ Value vs. Drain Current

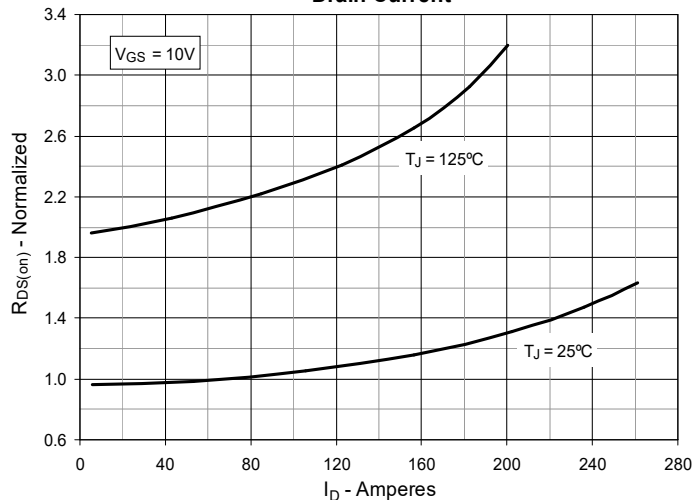

Fig. 6. Maximum Drain Current vs. Case Temperature

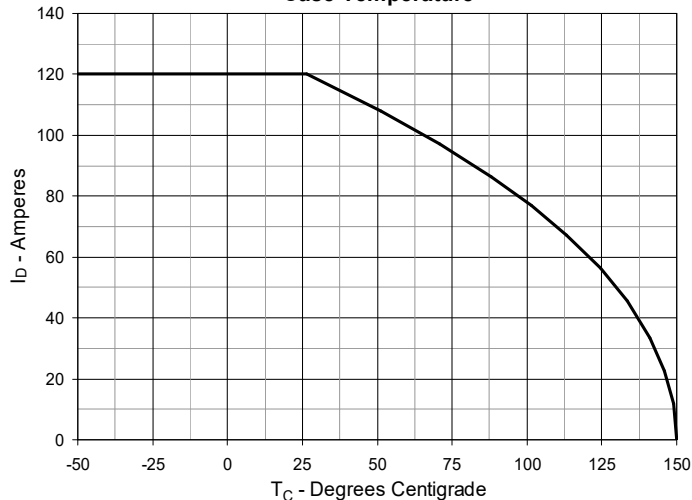

Fig. 7. Input Admittance

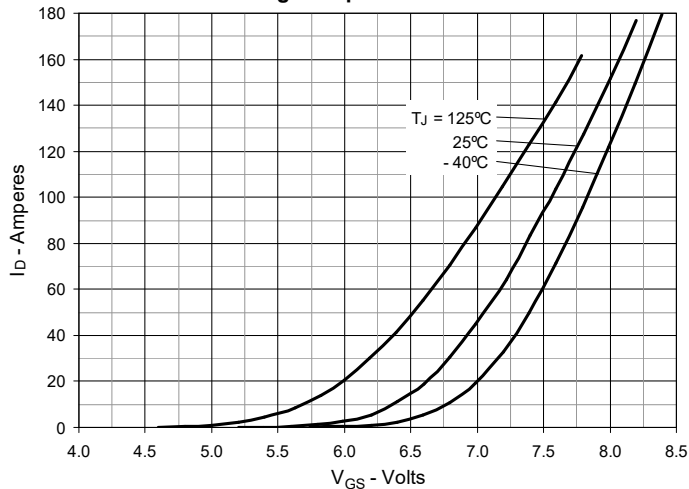

Fig. 8. Transconductance

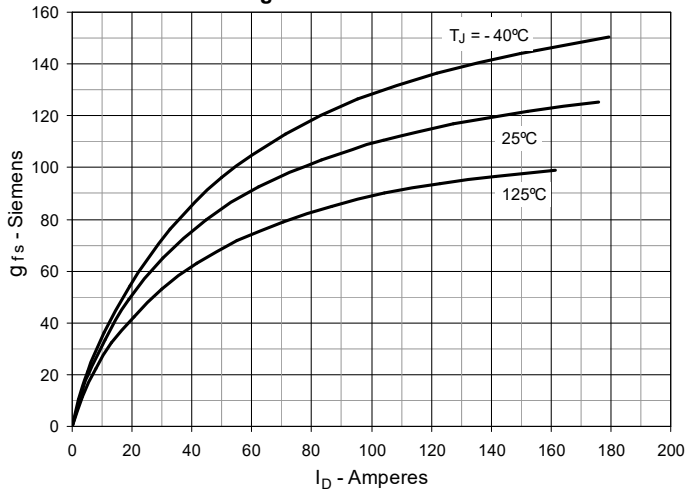

Fig. 9. Forward Voltage Drop of Intrinsic Diode

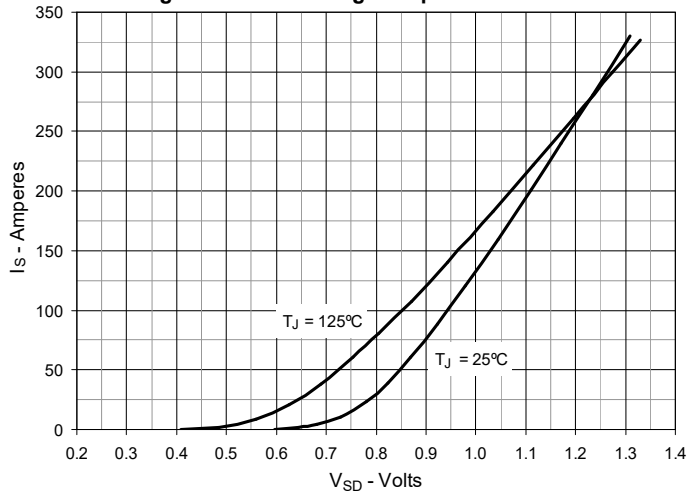

Fig. 10. Gate Charge

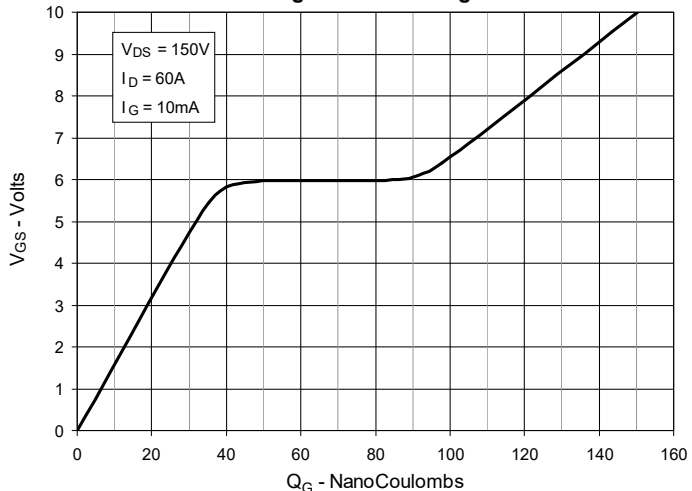

Fig. 11. Capacitance

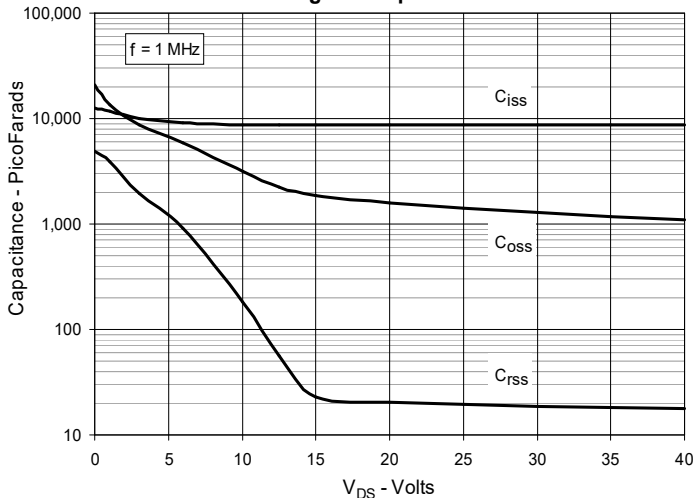

Fig. 12. Forward-Bias Safe Operating Area

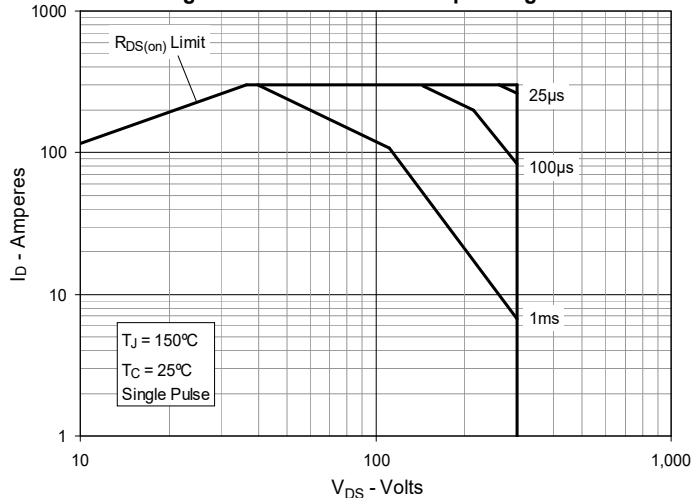
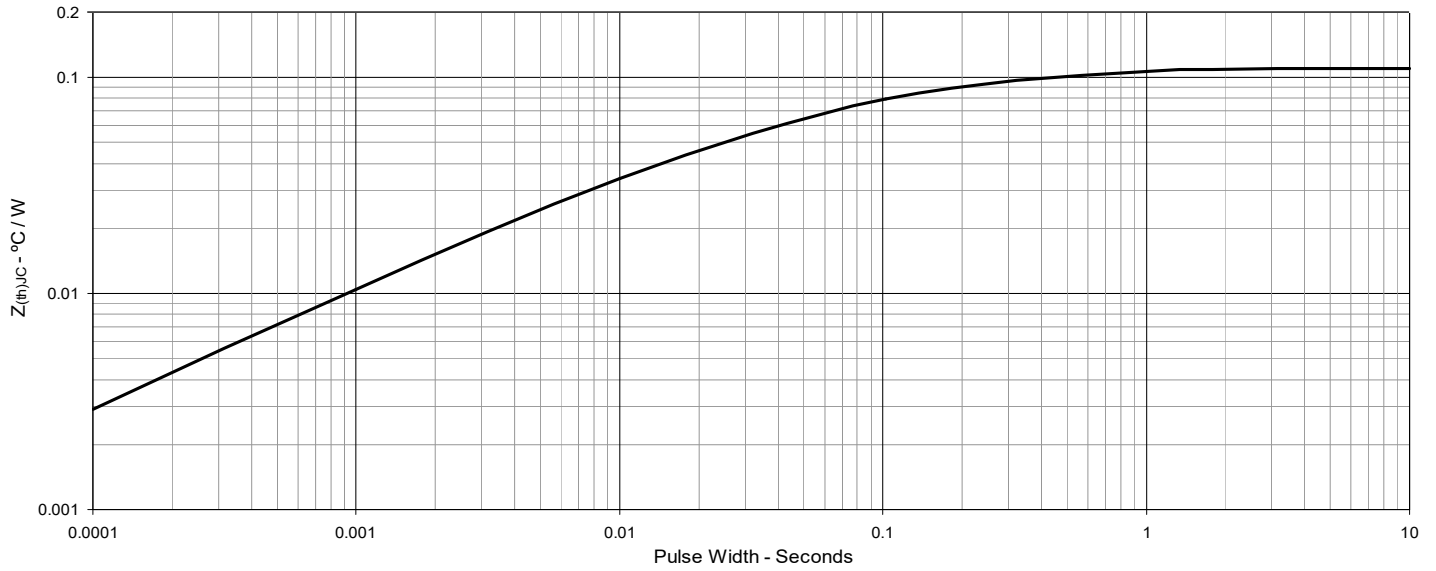
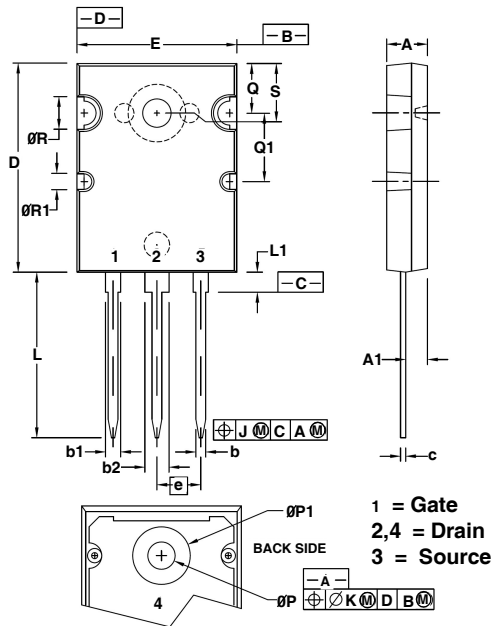
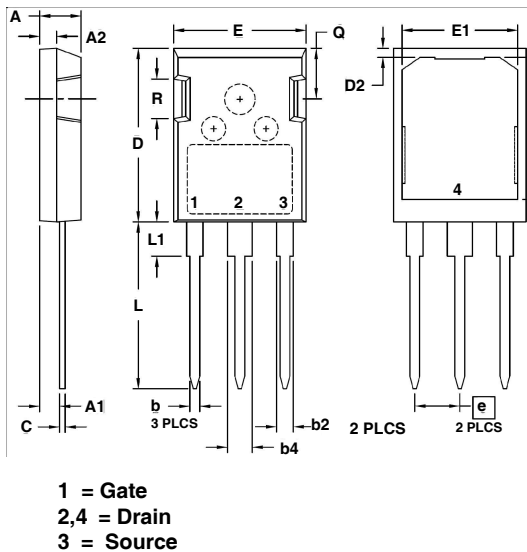

Fig. 13. Maximum Transient Thermal Impedance



TO-264 Outline

SYMBOL	INCHES		MILLIMETERS	
	MIN	MAX	MIN	MAX
A	.185	.209	4.70	5.31
A1	.102	.118	2.59	3.00
b	.037	.055	0.94	1.40
b1	.087	.102	2.21	2.59
b2	.110	.126	2.79	3.20
c	.017	.029	0.43	0.74
D	1.007	1.047	25.58	26.59
E	.760	.799	19.30	20.29
e	.215BSC		5.46 BSC	
J	.000	.010	0.00	0.25
K	.000	.010	0.00	0.25
L	.779	.842	19.79	21.39
L1	.087	.102	2.21	2.59
ØP	.122	.138	3.10	3.51
ØP1	.270	.290	6.86	7.37
Q	.240	.256	6.10	6.50
Q1	.330	.346	8.38	8.79
ØR	.155	.187	3.94	4.75
ØR1	.085	.093	2.16	2.36
S	.243	.253	6.17	6.43

PLUS247™ Outline

SYM	INCHES		MILLIMETERS	
	MIN	MAX	MIN	MAX
A	.190	.205	4.83	5.21
A1	.090	.100	2.29	2.54
A2	.075	.085	1.91	2.16
b	.045	.055	1.14	1.40
b2	.075	.087	1.91	2.20
b4	.115	.126	2.92	3.20
C	.024	.031	0.61	0.80
D	.819	.840	20.80	21.34
D1	.650	.690	16.51	17.53
D2	.035	.050	0.89	1.27
E	.620	.635	15.75	16.13
E1	.520	.560	13.08	14.22
e	.215 BSC		5.45 BSC	
L	.780	.810	19.81	20.57
L1	.150	.170	3.81	4.32
Q	.220	.244	5.59	6.20
R	.170	.190	4.32	4.83



Disclaimer Notice - Information furnished is believed to be accurate and reliable. However, users should independently evaluate the suitability of and test each product selected for their own applications. Littelfuse products are not designed for, and may not be used in, all applications. Read complete Disclaimer Notice at www.littelfuse.com/disclaimer-electronics.