

## Polar™ HiperFET™ Power MOSFET

**IXFK170N20P**  
**IXFX170N20P**

**V<sub>DSS</sub> = 200V**  
**I<sub>D25</sub> = 170A**  
**R<sub>DS(on)</sub> ≤ 14mΩ**

N-Channel Enhancement Mode  
Avalanche Rated  
Fast Intrinsic Diode

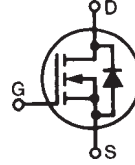

Symbol	Test Conditions	Maximum Ratings	
V <sub>DSS</sub>	T <sub>J</sub> = 25°C to 175°C	200	V
V <sub>DGR</sub>	T <sub>J</sub> = 25°C to 175°C, R <sub>GS</sub> = 1MΩ	200	V
V <sub>GSS</sub>	Continuous	±20	V
V <sub>GSM</sub>	Transient	±30	V
I <sub>D25</sub>	T <sub>C</sub> = 25°C	170	A
I <sub>LRMS</sub>	Lead Current Limit	160	A
I <sub>DM</sub>	T <sub>C</sub> = 25°C, Pulse Width Limited by T <sub>JM</sub>	400	A
I <sub>A</sub>	T <sub>C</sub> = 25°C	85	A
E <sub>AS</sub>	T <sub>C</sub> = 25°C	4	J
dv/dt	I <sub>S</sub> ≤ I <sub>DM</sub> , V <sub>DD</sub> ≤ V <sub>DSS</sub> , T <sub>J</sub> ≤ 175°C	20	V/ns
P <sub>D</sub>	T <sub>C</sub> = 25°C	1250	W
T <sub>J</sub>		-55 ... +175	°C
T <sub>JM</sub>		175	°C
T <sub>stg</sub>		-55 ... +175	°C
L	Maximum Lead Temperature for Soldering	300	°C
T <sub>SOLD</sub>	1.6 mm (0.062in.) from Case for 10s	260	°C
M <sub>d</sub>	Mounting Force (PLUS247) Mounting Torque (TO-264)	20..120/4.5..27 1.13/10	N/lb Nm/lb.in
Weight	PLUS247 TO-264	6 10	g g

TO-264 (IXFK)

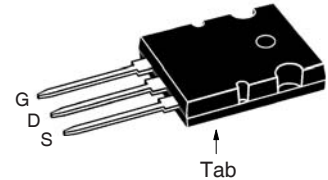

PLUS247 (IXFX)

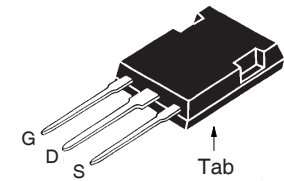

G = Gate      D = Drain  
S = Source    Tab = Drain

### Features

- Dynamic dv/dt Rating
- Avalanche Rated
- Fast Intrinsic Diode
- Low Q<sub>G</sub>
- Low R<sub>DS(on)</sub>
- Low Drain-to-Tab Capacitance
- Low Package Inductance

### Advantages

- Easy to Mount
- Space Savings

### Applications

- DC-DC Converters
- Battery Chargers
- Switch-Mode and Resonant-Mode Power Supplies
- Uninterrupted Power Supplies
- AC Motor Drives
- DC Choppers
- High Speed Power Switching Applications

Symbol	Test Conditions (T <sub>J</sub> = 25°C, Unless Otherwise Specified)	Characteristic Values		
		Min.	Typ.	Max.
BV <sub>DSS</sub>	V <sub>GS</sub> = 0V, I <sub>D</sub> = 3mA	200		V
V <sub>GS(th)</sub>	V <sub>DS</sub> = V <sub>GS</sub> , I <sub>D</sub> = 1mA	2.5		4.5 V
I <sub>GSS</sub>	V <sub>GS</sub> = ±20V, V <sub>DS</sub> = 0V			±200 nA
I <sub>DSS</sub>	V <sub>DS</sub> = V <sub>DSS</sub> , V <sub>GS</sub> = 0V T <sub>J</sub> = 150°C			50 μA 1 mA
R <sub>DS(on)</sub>	V <sub>GS</sub> = 10V, I <sub>D</sub> = 0.5 • I <sub>D25</sub> , Note 1			14 mΩ

Symbol	Test Conditions ( $T_J = 25^\circ\text{C}$ , Unless Otherwise Specified)	Characteristic Values		
		Min.	Typ.	Max.
$g_{fs}$	$V_{DS} = 10\text{V}, I_D = 60\text{A}$ , Note 1	45	75	S
$C_{iss}$	$V_{GS} = 0\text{V}, V_{DS} = 25\text{V}, f = 1\text{MHz}$		11.4	nF
$C_{oss}$			2440	pF
$C_{rss}$			70	pF
$t_{d(on)}$	<b>Resistive Switching Times</b> $V_{GS} = 10\text{V}, V_{DS} = 0.5 \cdot V_{DSS}, I_D = 0.5 \cdot I_{D25}$ $R_G = 1\Omega$ (External)		40	ns
$t_r$			25	ns
$t_{d(off)}$			50	ns
$t_f$			14	ns
$Q_{g(on)}$	$V_{GS} = 10\text{V}, V_{DS} = 0.5 \cdot V_{DSS}, I_D = 0.5 \cdot I_{D25}$		185	nC
$Q_{gs}$			80	nC
$Q_{gd}$			60	nC
$R_{thJC}$			0.12	$^\circ\text{C/W}$
$R_{thCS}$		0.15		$^\circ\text{C/W}$

### Source-Drain Diode

Symbol	Test Conditions ( $T_J = 25^\circ\text{C}$ , Unless Otherwise Specified)	Characteristic Values		
		Min.	Typ.	Max.
$I_S$	$V_{GS} = 0\text{V}$			170 A
$I_{SM}$	Repetitive, Pulse Width Limited by $T_{JM}$			510 A
$V_{SD}$	$I_F = 85\text{A}, V_{GS} = 0\text{V}$ , Note 1			1.3 V
$t_{rr}$	$I_F = 85\text{A}, -di/dt = 150\text{A}/\mu\text{s}$ $V_R = 100\text{V}, V_{GS} = 0\text{V}$		1.6	200 ns
$Q_{RM}$			20	$\mu\text{C}$
$I_{RM}$				A

Note 1: Pulse test,  $t \leq 300\mu\text{s}$ , duty cycle,  $d \leq 2\%$ .

### TO-264 AA Outline

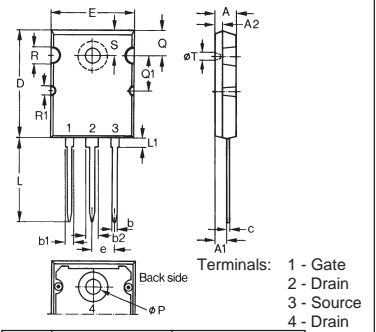

Dim.	Millimeter		Inches	
	Min.	Max.	Min.	Max.
A	4.82	5.13	.190	.202
A1	2.54	2.89	.100	.114
A2	2.00	2.10	.079	.083
b	1.12	1.42	.044	.056
b1	2.39	2.69	.094	.106
b2	2.90	3.09	.114	.122
c	0.53	0.83	.021	.033
D	25.91	26.16	1.020	1.030
E	19.81	19.96	.780	.786
e	5.46 BSC		.215 BSC	
J	0.00	0.25	.000	.010
K	0.00	0.25	.000	.010
L	20.32	20.83	.800	.820
L1	2.29	2.59	.090	.102
P	3.17	3.66	.125	.144
Q	6.07	6.27	.239	.247
Q1	8.38	8.69	.330	.342
R	3.81	4.32	.150	.170
R1	1.78	2.29	.070	.090
S	6.04	6.30	.238	.248
T	1.57	1.83	.062	.072

### PLUS247™ Outline

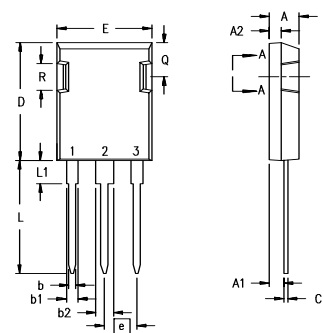

Terminals: 1 - Gate  
2 - Drain  
3 - Source

Dim.	Millimeter		Inches	
	Min.	Max.	Min.	Max.
A	4.83	5.21	.190	.205
A1	2.29	2.54	.090	.100
A2	1.91	2.16	.075	.085
b	1.14	1.40	.045	.055
b1	1.91	2.13	.075	.084
b2	2.92	3.12	.115	.123
C	0.61	0.80	.024	.031
D	20.80	21.34	.819	.840
E	15.75	16.13	.620	.635
e	5.45 BSC		.215 BSC	
L	19.81	20.32	.780	.800
L1	3.81	4.32	.150	.170
Q	5.59	6.20	.220	0.244
R	4.32	4.83	.170	.190

IXYS Reserves the Right to Change Limits, Test Conditions, and Dimensions.

IXYS MOSFETs and IGBTs are covered by one or more of the following U.S. patents:	4,835,592	4,931,844	5,049,961	5,237,481	6,162,665	6,404,065 B1	6,683,344	6,727,585	7,005,734 B2	7,157,338B2
	4,860,072	5,017,508	5,063,307	5,381,025	6,259,123 B1	6,534,343	6,710,405 B2	6,759,692	7,063,975 B2	
	4,881,106	5,034,796	5,187,117	5,486,715	6,306,728 B1	6,583,505	6,710,463	6,771,478 B2	7,071,537	

Fig. 1. Output Characteristics @  $T_J = 25^\circ\text{C}$

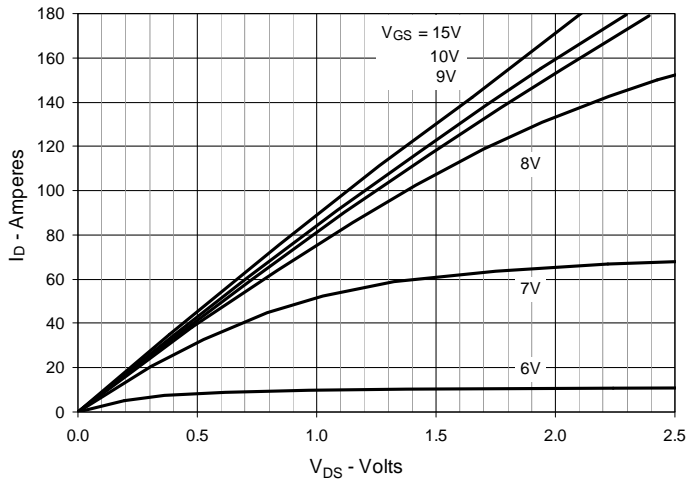

Fig. 2. Extended Output Characteristics @  $T_J = 25^\circ\text{C}$

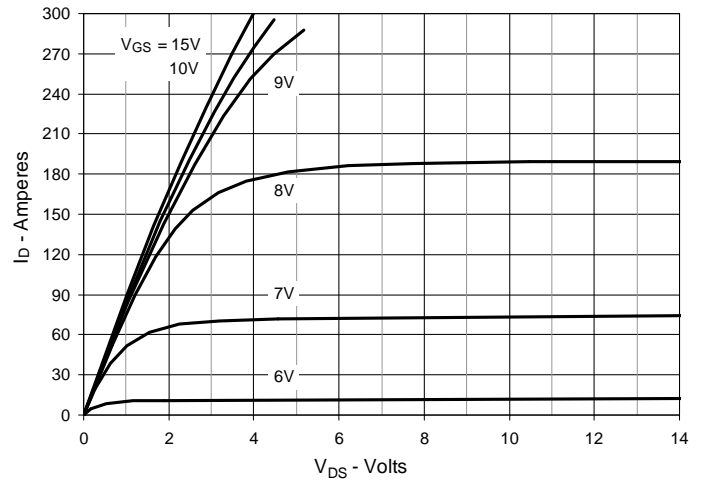

Fig. 3. Output Characteristics @  $T_J = 150^\circ\text{C}$

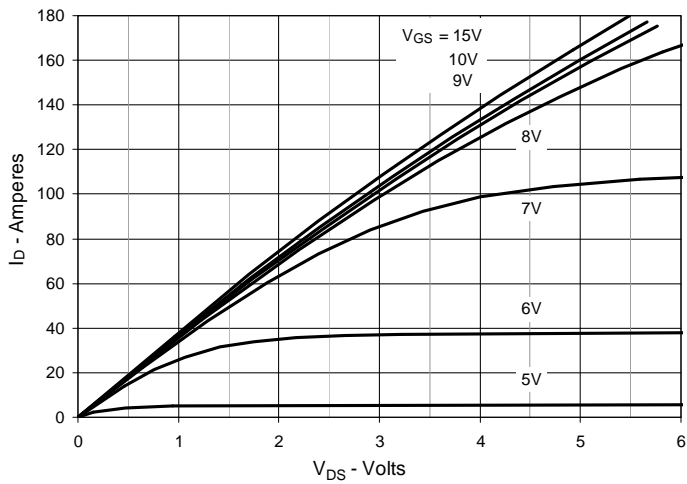

Fig. 4.  $R_{DS(on)}$  Normalized to  $I_D = 85\text{A}$  Value vs. Junction Temperature

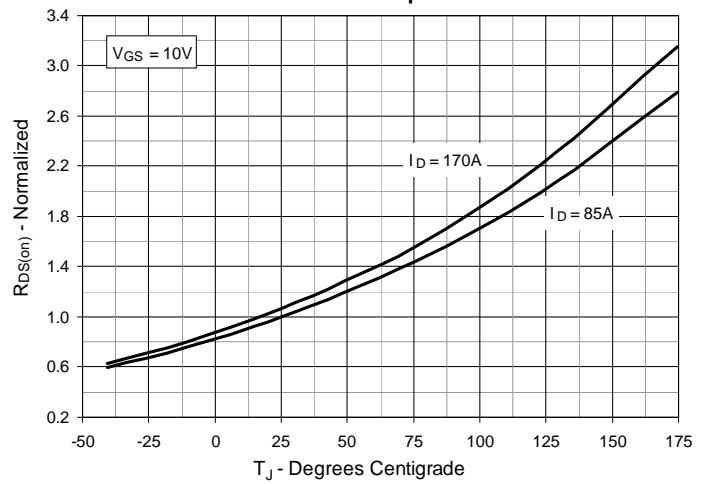

Fig. 5.  $R_{DS(on)}$  Normalized to  $I_D = 85\text{A}$  Value vs. Drain Current

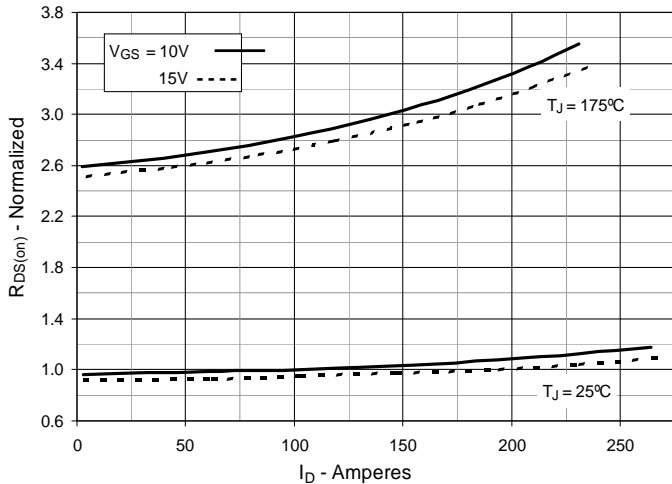
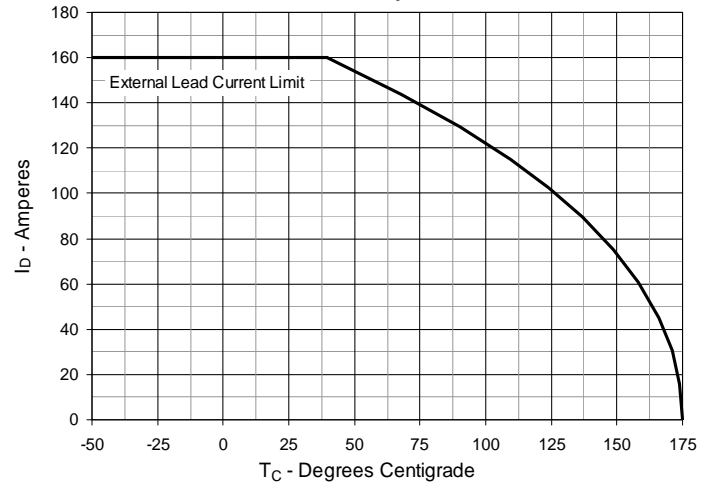
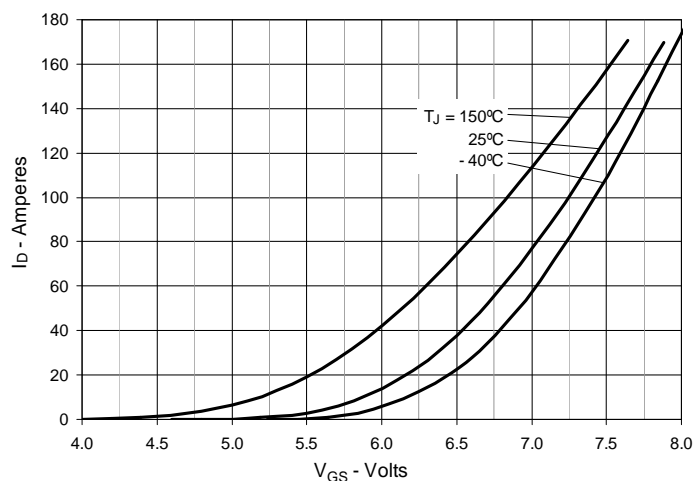

Fig. 6. Maximum Drain Current vs. Case Temperature



**Fig. 7. Input Admittance**



**Fig. 8. Transconductance**

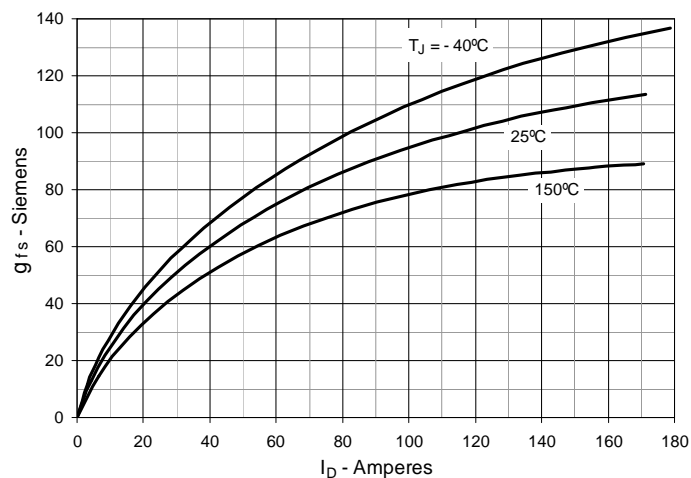

**Fig. 9. Forward Voltage Drop of Intrinsic Diode**

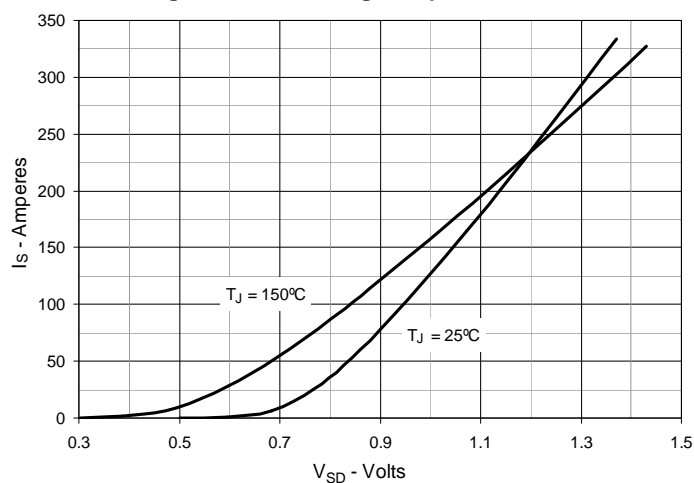

**Fig. 10. Gate Charge**

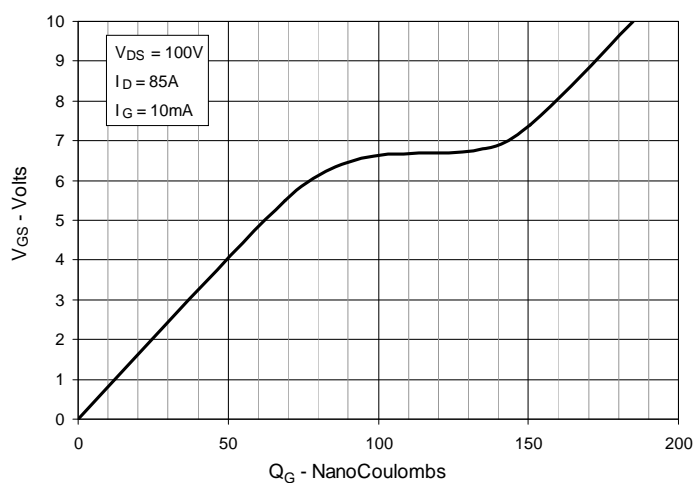

**Fig. 11. Capacitance**

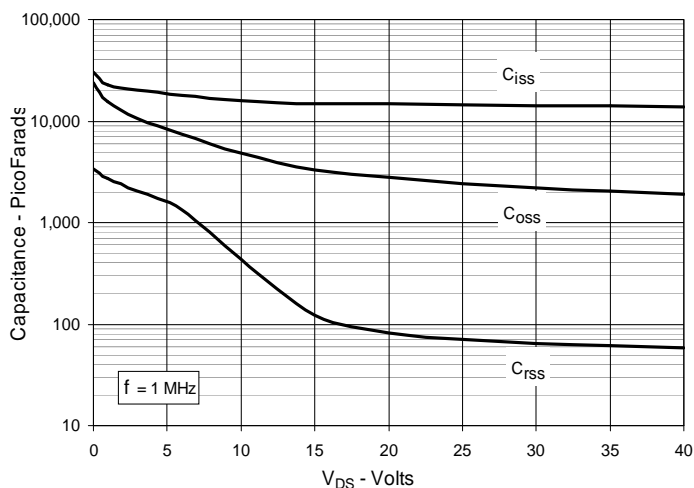

**Fig. 12. Forward-Bias Safe Operating Area**

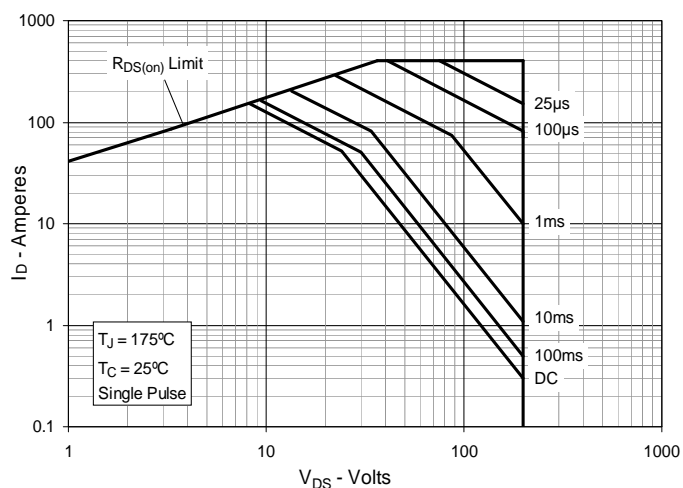
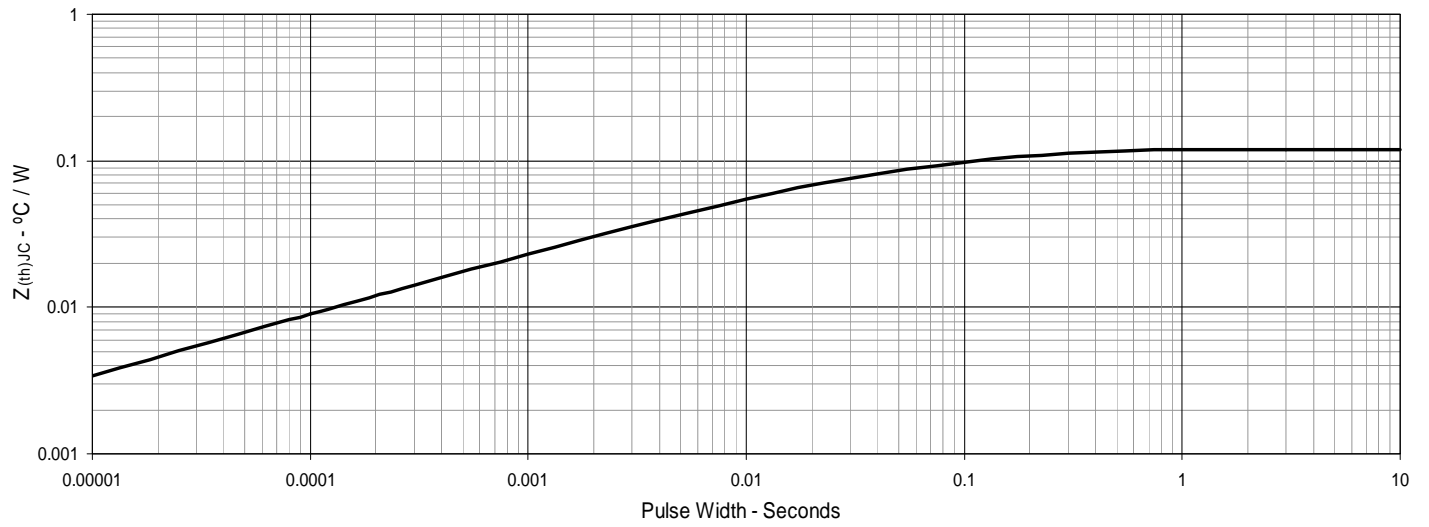

Fig. 13. Maximum Transient Thermal Impedance





---

Disclaimer Notice - Information furnished is believed to be accurate and reliable. However, users should independently evaluate the suitability of and test each product selected for their own applications. Littelfuse products are not designed for, and may not be used in, all applications. Read complete Disclaimer Notice at [www.littelfuse.com/disclaimer-electronics](http://www.littelfuse.com/disclaimer-electronics).