

HiPerFET™

Power MOSFETs

Q-Class

N-Channel Enhancement Mode
Avalanche Rated, Low Q_g , High dv/dt

IXFH/IXFT 24N50Q
IXFH/IXFT 26N50Q

V_{DSS}	I_{D25}	$R_{DS(on)}$
500 V	24 A	0.23 Ω
500 V	26 A	0.20 Ω

$t_{rr} \leq 250$ ns

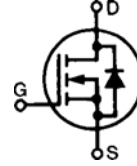

Symbol	Test Conditions	Maximum Ratings	
V_{DSS}	$T_J = 25^\circ\text{C}$ to 150°C	500	V
V_{DGR}	$T_J = 25^\circ\text{C}$ to 150°C ; $R_{GS} = 1$ M Ω	500	V
V_{GS}	Continuous	± 20	V
V_{GSM}	Transient	± 30	V
I_{D25}	$T_C = 25^\circ\text{C}$	24N50Q	24 A
		26N50Q	26 A
I_{DM}	$T_C = 25^\circ\text{C}$, Note 1	24N50Q	96 A
		26N50Q	104 A
I_{AR}	$T_C = 25^\circ\text{C}$	24N50Q	24 A
		26N50Q	26 A
E_{AR}	$T_C = 25^\circ\text{C}$	30	mJ
E_{AS}	$T_C = 25^\circ\text{C}$	1.5	J
dv/dt	$I_S \leq I_{DM}$, $di/dt \leq 100$ A/ μs , $V_{DD} \leq V_{DSS}$, $T_J \leq 150^\circ\text{C}$, $R_G = 2$ Ω	5	V/ns
P_D	$T_C = 25^\circ\text{C}$	300	W
T_J		-55 ... +150	$^\circ\text{C}$
T_{JM}		150	$^\circ\text{C}$
T_{stg}		-55 ... +150	$^\circ\text{C}$
T_L	1.6 mm (0.063 in) from case for 10 s	300	$^\circ\text{C}$
M_d	Mounting torque	1.13/10	Nm/lb.in.
Weight	TO-247	6	g
	TO-268	4	g

TO-247 AD (IXFH)

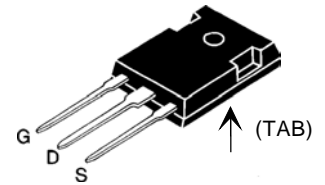

TO-268 (D3) (IXFT) Case Style

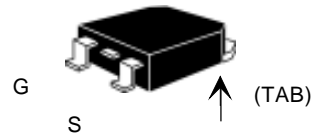

G = Gate, D = Drain,
S = Source, TAB = Drain

Features

- IXYS advanced low Q_g process
- International standard packages
- Low $R_{DS(on)}$
- Unclamped Inductive Switching (UIS) rated
- Fast switching
- Molding epoxies meet UL 94 V-0 flammability classification

Advantages

- Easy to mount
- Space savings
- High power density

Symbol	Test Conditions	Characteristic Values ($T_J = 25^\circ\text{C}$, unless otherwise specified)		
		min.	typ.	max.
V_{DSS}	$V_{GS} = 0$ V, $I_D = 250$ μA	500		V
$V_{GS(th)}$	$V_{DS} = V_{GS}$, $I_D = 4$ mA	2.5		V
I_{GSS}	$V_{GS} = \pm 20$ V $_{DC}$, $V_{DS} = 0$			± 100 nA
I_{DSS}	$V_{DS} = V_{DSS}$, $V_{GS} = 0$ V	$T_J = 25^\circ\text{C}$		25 μA
		$T_J = 125^\circ\text{C}$		1 mA
$R_{DS(on)}$	$V_{GS} = 10$ V, $I_D = 0.5$ I_{D25} Note 2	24N50Q		0.23 Ω
		26N50Q		0.20 Ω

Symbol	Test Conditions	Characteristic Values		
		$(T_J = 25^\circ\text{C}, \text{ unless otherwise specified})$		
		min.	typ.	max.
g_{fs}	$V_{DS} = 10\text{ V}; I_D = 0.5 \cdot I_{D25}$, Note 2	14	24	S
C_{iss}	$V_{GS} = 0\text{ V}, V_{DS} = 25\text{ V}, f = 1\text{ MHz}$		3900	pF
C_{oss}			500	pF
C_{rss}			130	pF
$t_{d(on)}$	$V_{GS} = 10\text{ V}, V_{DS} = 0.5 \cdot V_{DSS}, I_D = 0.5 \cdot I_{D25}$ $R_G = 2\ \Omega$ (External),		28	ns
t_r			30	ns
$t_{d(off)}$			55	ns
t_f			16	ns
$Q_{g(on)}$	$V_{GS} = 10\text{ V}, V_{DS} = 0.5 \cdot V_{DSS}, I_D = 0.5 \cdot I_{D25}$		95	nC
Q_{gs}			27	nC
Q_{gd}			40	nC
R_{thJC}	(TO-247)			0.42 KW
R_{thCK}			0.25	

Source-Drain Diode		Characteristic Values		
		$(T_J = 25^\circ\text{C}, \text{ unless otherwise specified})$		
Symbol	Test Conditions	min.	typ.	max.
I_S	$V_{GS} = 0\text{ V}$	24N50Q 26N50Q		24 26 A
I_{SM}	Repetitive; Note 1	24N50Q 26N50Q		96 104 A
V_{SD}	$I_F = I_S, V_{GS} = 0\text{ V},$ Pulse test, $t \leq 300\ \mu\text{s}$, duty cycle $d \leq 2\%$			1.3 V
t_{rr}	$I_F = I_S, -di/dt = 100\text{ A}/\mu\text{s}, V_R = 100\text{ V}$		0.85	250 ns
Q_{RM}				μC
I_{RM}			8	A

Note 1. Pulse width limited by T_{JM}
 2. Pulse test, $t \leq 300\ \mu\text{s}$, duty cycle $d \leq 2\%$

Min Recommended Footprint

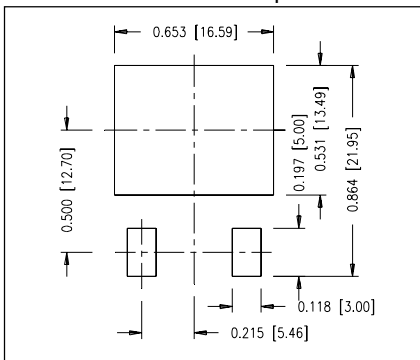

TO-247 AD Outline

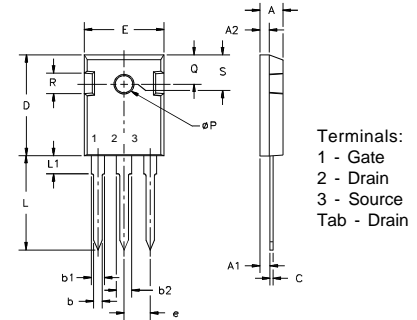

Dim.	Millimeter		Inches	
	Min.	Max.	Min.	Max.
A	4.7	5.3	.185	.209
A ₁	2.2	2.54	.087	.102
A ₂	2.2	2.6	.059	.098
b	1.0	1.4	.040	.055
b ₁	1.65	2.13	.065	.084
b ₂	2.87	3.12	.113	.123
C	.4	.8	.016	.031
D	20.80	21.46	.819	.845
E	15.75	16.26	.610	.640
e	5.20	5.72	0.205	0.225
L	19.81	20.32	.780	.800
L1		4.50		.177
ØP	3.55	3.65	.140	.144
Q	5.89	6.40	0.232	0.252
R	4.32	5.49	.170	.216
S	6.15	BSC	242	BSC

TO-268 Outline

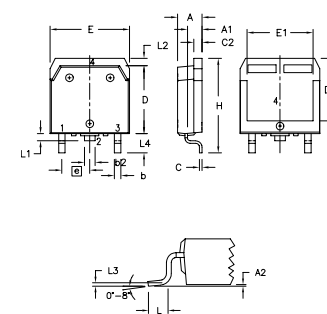

Dim.	Millimeter		Inches	
	Min.	Max.	Min.	Max.
A	4.9	5.1	.193	.201
A ₁	2.7	2.9	.106	.114
A ₂	.02	.25	.001	.010
b	1.15	1.45	.045	.057
b ₁	1.9	2.1	.75	.83
b ₂	.4	.65	.016	.026
D	13.80	14.00	.543	.551
E	15.85	16.05	.624	.632
E ₁	13.3	13.6	.524	.535
e	5.45	BSC	.215	BSC
H	18.70	19.10	.736	.752
L	2.40	2.70	.094	.106
L1	1.20	1.40	.047	.055
L2	1.00	1.15	.039	.045
L3	0.25	BSC	.010	BSC
L4	3.80	4.10	.150	.161

IXYS reserves the right to change limits, test conditions, and dimensions.

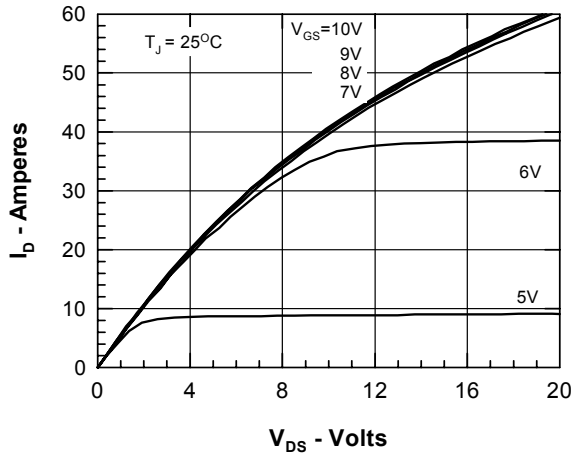

Fig.1 Output Characteristics @ $T_J = 25^\circ\text{C}$

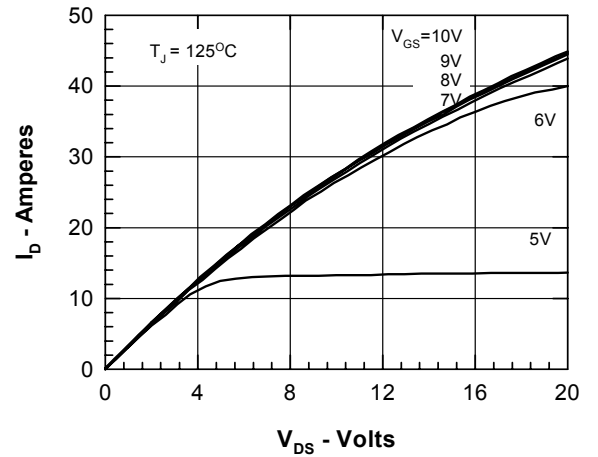

Fig.2 Output Characteristics @ $T_J = 125^\circ\text{C}$

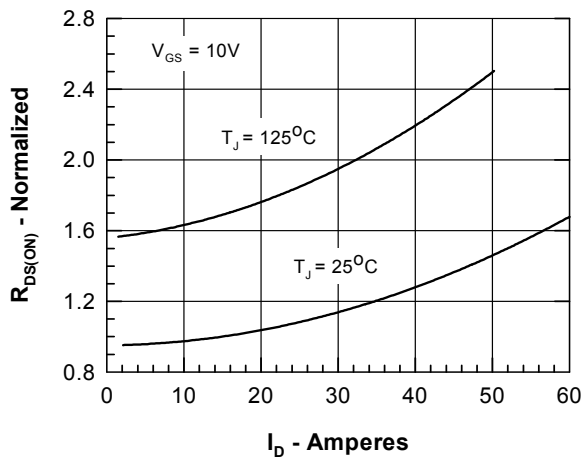

Fig.3 $R_{DS(on)}$ vs. Drain Current

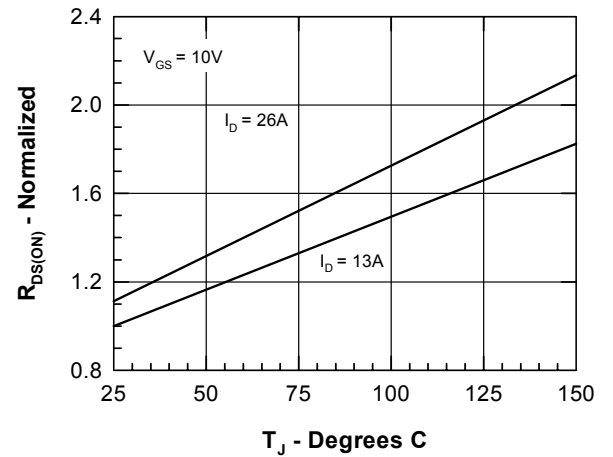

Fig.4 Temperature Dependence of Drain to Source Resistance

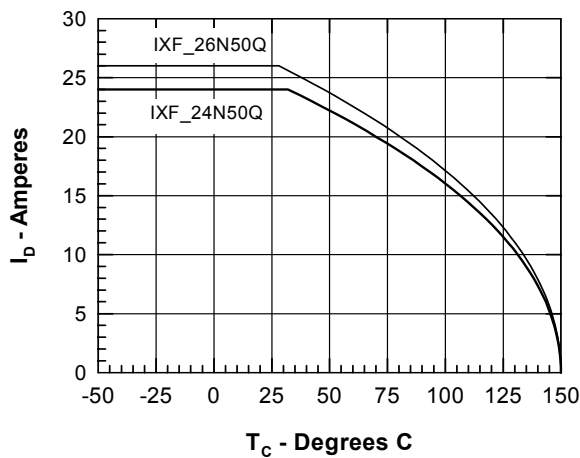

Fig.5 Drain Current vs. Case Temperature

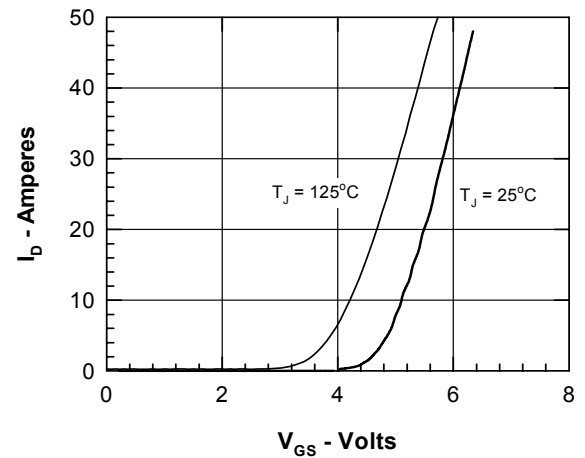

Fig.6 Drain Current vs. Gate Source Voltage

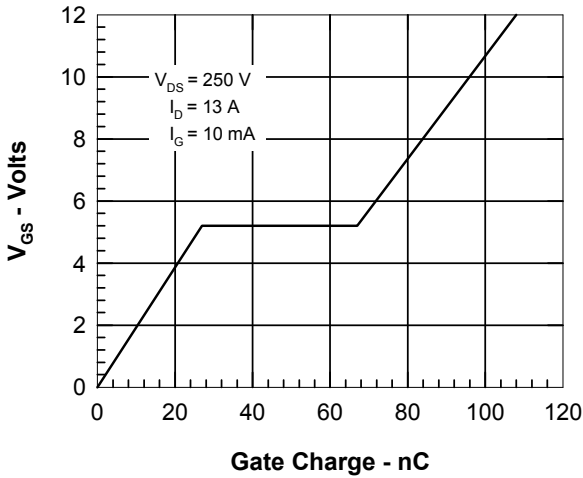

Fig.7 Gate Charge Characteristic Curve

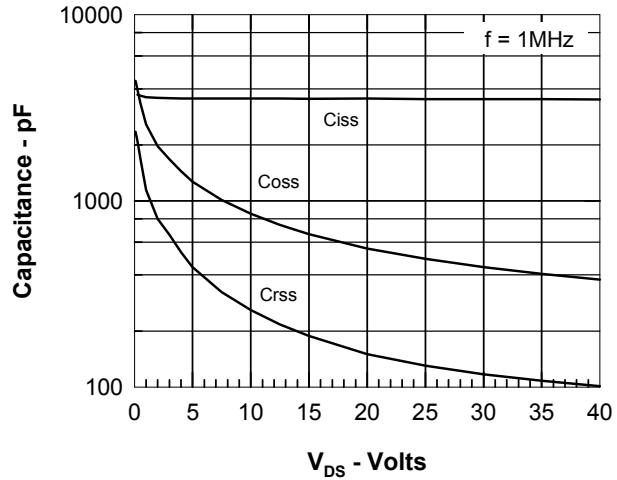

Fig.8 Capacitance Curves

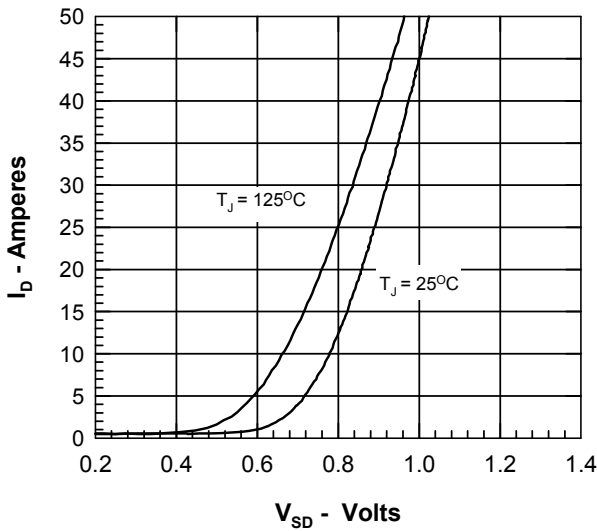

Fig.9 Drain Current vs Drain to Source Voltage

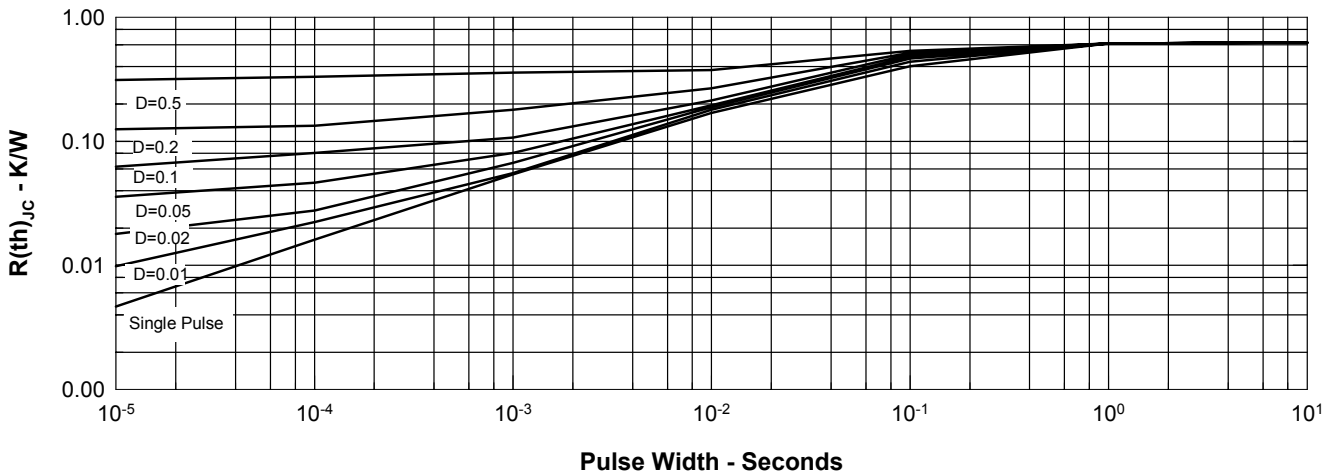

Fig.10 Transient Thermal Impedance

IXYS reserves the right to change limits, test conditions, and dimensions.



Disclaimer Notice - Information furnished is believed to be accurate and reliable. However, users should independently evaluate the suitability of and test each product selected for their own applications. Littelfuse products are not designed for, and may not be used in, all applications. Read complete Disclaimer Notice at www.littelfuse.com/disclaimer-electronics.