

**Q3-Class
HiperFET™
Power MOSFET**

**IXFT44N50Q3
IXFH44N50Q3**

V_{DSS} = 500V
I_{D25} = 44A
R_{DS(on)} ≤ 140mΩ
t_{rr} ≤ 250ns

N-Channel Enhancement Mode
 Avalanche Rated
 Fast Intrinsic Rectifier

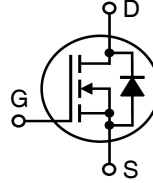

**TO-268
(IXFT)**

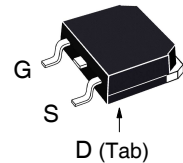

**TO-247
(IXFH)**

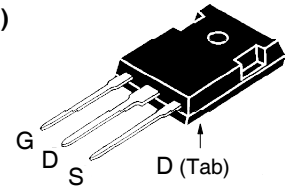

G = Gate D = Drain
 S = Source Tab = Drain

Symbol	Test Conditions	Maximum Ratings	
V _{DSS}	T _J = 25°C to 150°C	500	V
V _{DGR}	T _J = 25°C to 150°C, R _{GS} = 1MΩ	500	V
V _{GSS}	Continuous	± 30	V
V _{GSM}	Transient	± 40	V
I _{D25}	T _C = 25°C	44	A
I _{DM}	T _C = 25°C, Pulse Width Limited by T _{JM}	130	A
I _A	T _C = 25°C	44	A
E _{AS}	T _C = 25°C	1.5	J
dv/dt	I _S ≤ I _{DM} , V _{DD} ≤ V _{DSS} , T _J ≤ 150°C	50	V/ns
P _D	T _C = 25°C	830	W
T _J		-55 ... +150	°C
T _{JM}		150	°C
T _{stg}		-55 ... +150	°C
T _L	Maximum Lead Temperature for Soldering	300	°C
T _{SOLD}	1.6 mm (0.062in.) from Case for 10s	260	°C
M _d	Mounting Torque (TO-247)	1.13 / 10	Nm/lb.in.
Weight	TO-268	4.0	g
	TO-247	6.0	g

Symbol	Test Conditions (T _J = 25°C Unless Otherwise Specified)	Characteristic Values		
		Min.	Typ.	Max.
BV _{DSS}	V _{GS} = 0V, I _D = 1mA	500		V
V _{GS(th)}	V _{DS} = V _{GS} , I _D = 4mA	3.5		6.5 V
I _{GSS}	V _{GS} = ±30V, V _{DS} = 0V			±100 nA
I _{DSS}	V _{DS} = V _{DSS} , V _{GS} = 0V T _J = 125°C			25 μA 1 mA
R _{DS(on)}	V _{GS} = 10V, I _D = 0.5 • I _{D25} , Note 1			140 mΩ

Features

- Low Intrinsic Gate Resistance
- International Standard Packages
- Low Package Inductance
- Avalanche Rated
- Fast Intrinsic Rectifier
- Low R_{DS(on)} and Q_G

Advantages

- High Power Density
- Easy to Mount
- Space Savings

Applications

- DC-DC Converters
- Battery Chargers
- Switch-Mode and Resonant-Mode Power Supplies
- DC Choppers
- Temperature and Lighting Controls

Symbol	Test Conditions ($T_J = 25^\circ\text{C}$ Unless Otherwise Specified)	Characteristic Values		
		Min.	Typ.	Max.
g_{fs}	$V_{DS} = 20\text{V}, I_D = 0.5 \cdot I_{D25}$, Note 1	17	28	S
C_{iss}	} $V_{GS} = 0\text{V}, V_{DS} = 25\text{V}, f = 1\text{MHz}$		4800	pF
C_{oss}			625	pF
C_{rss}			56	pF
R_{Gi}	Gate Input Resistance		0.13	Ω
$t_{d(on)}$	} Resistive Switching Times $V_{GS} = 10\text{V}, V_{DS} = 0.5 \cdot V_{DSS}, I_D = 0.5 \cdot I_{D25}$ $R_G = 2\Omega$ (External)		30	ns
t_r			13	ns
$t_{d(off)}$			37	ns
t_f			9	ns
$Q_{g(on)}$	} $V_{GS} = 10\text{V}, V_{DS} = 0.5 \cdot V_{DSS}, I_D = 0.5 \cdot I_{D25}$		93	nC
Q_{gs}			34	nC
Q_{gd}			44	nC
R_{thJC}				0.15 $^\circ\text{C/W}$
R_{thCS}	TO-247		0.21	$^\circ\text{C/W}$

Source-Drain Diode

Symbol	Test Conditions ($T_J = 25^\circ\text{C}$ Unless Otherwise Specified)	Characteristic Values		
		Min.	Typ.	Max.
I_S	$V_{GS} = 0\text{V}$			44 A
I_{SM}	Repetitive, Pulse Width Limited by T_{JM}			176 A
V_{SD}	$I_F = I_S, V_{GS} = 0\text{V}$, Note 1			1.4 V
t_{rr}	} $I_F = 22\text{A}, -di/dt = 100\text{A}/\mu\text{s}$ $V_R = 100\text{V}, V_{GS} = 0\text{V}$			250 ns
I_{RM}			13.2	A
Q_{RM}			1.4	μC

Note 1. Pulse test, $t \leq 300\mu\text{s}$, duty cycle, $d \leq 2\%$.

IXYS Reserves the Right to Change Limits, Test Conditions, and Dimensions.

IXYS MOSFETs and IGBTs are covered	4,835,592	4,931,844	5,049,961	5,237,481	6,162,665	6,404,065 B1	6,683,344	6,727,585	7,005,734 B2	7,157,338B2
by one or more of the following U.S. patents:	4,860,072	5,017,508	5,063,307	5,381,025	6,259,123 B1	6,534,343	6,710,405 B2	6,759,692	7,063,975 B2	
	4,881,106	5,034,796	5,187,117	5,486,715	6,306,728 B1	6,583,505	6,710,463	6,771,478 B2	7,071,537	

Fig. 1. Output Characteristics @ $T_J = 25^\circ\text{C}$

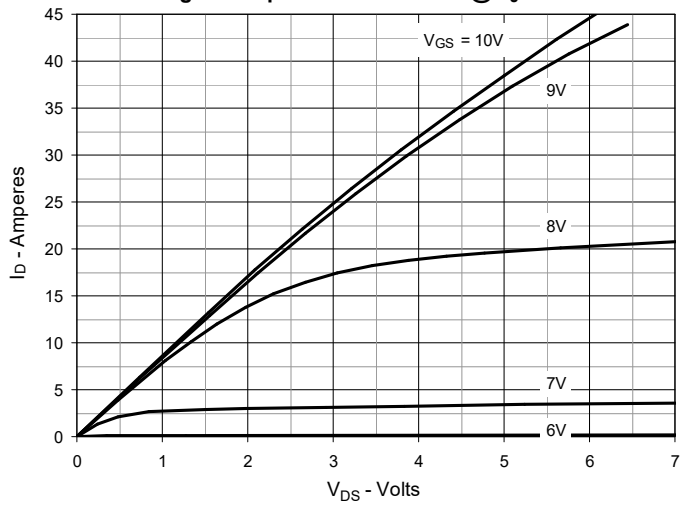

Fig. 2. Extended Output Characteristics @ $T_J = 25^\circ\text{C}$

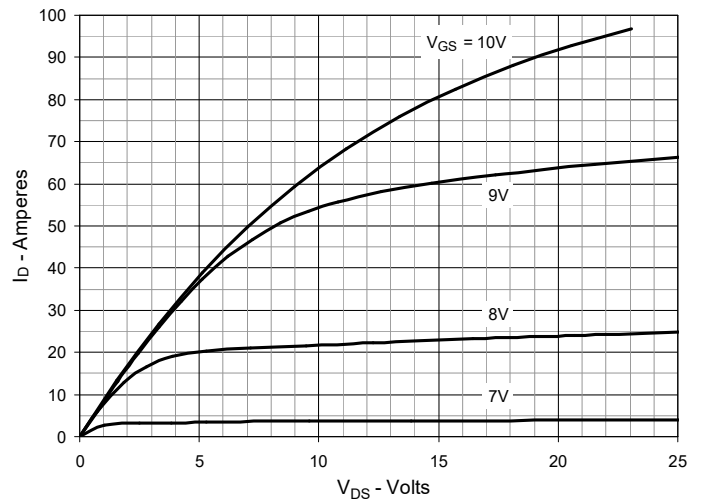

Fig. 3. Output Characteristics @ $T_J = 125^\circ\text{C}$

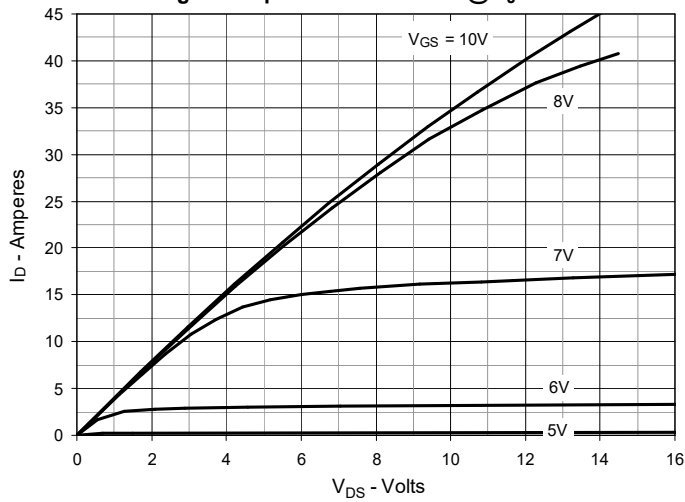

Fig. 4. $R_{DS(on)}$ Normalized to $I_D = 22\text{A}$ Value vs. Junction Temperature

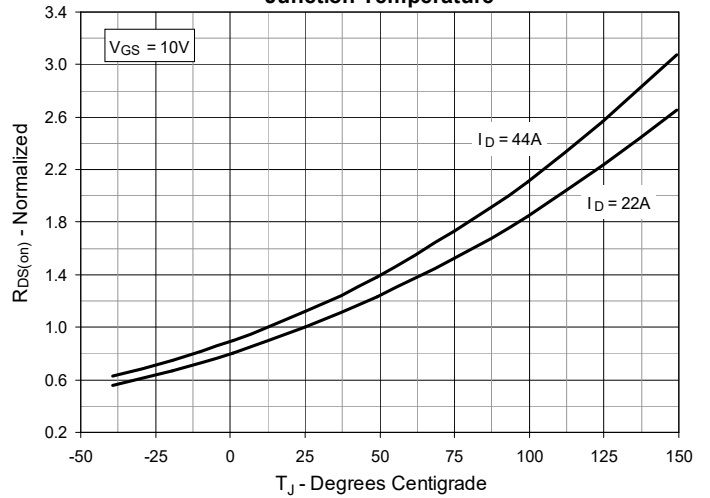

Fig. 5. $R_{DS(on)}$ Normalized to $I_D = 22\text{A}$ Value vs. Drain Current

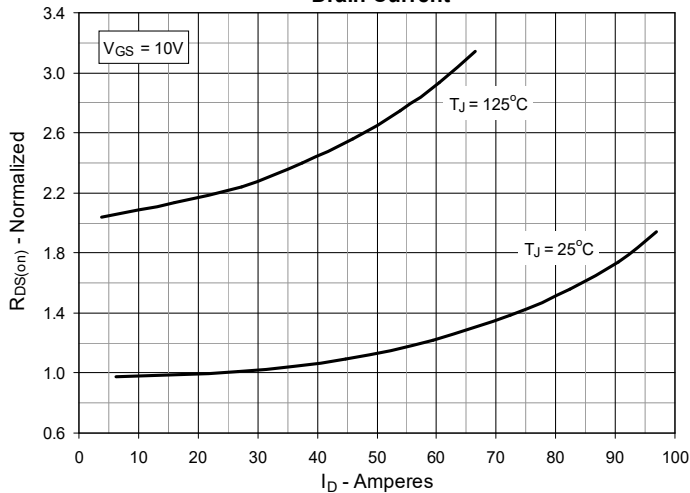

Fig. 6. Maximum Drain Current vs. Case Temperature

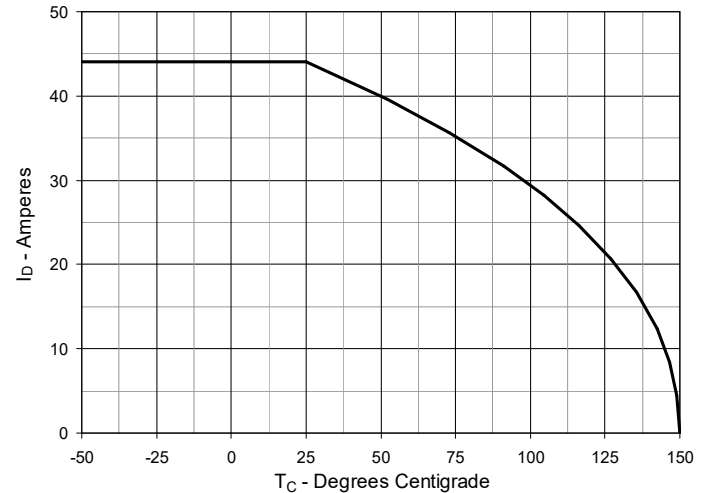

Fig. 7. Input Admittance

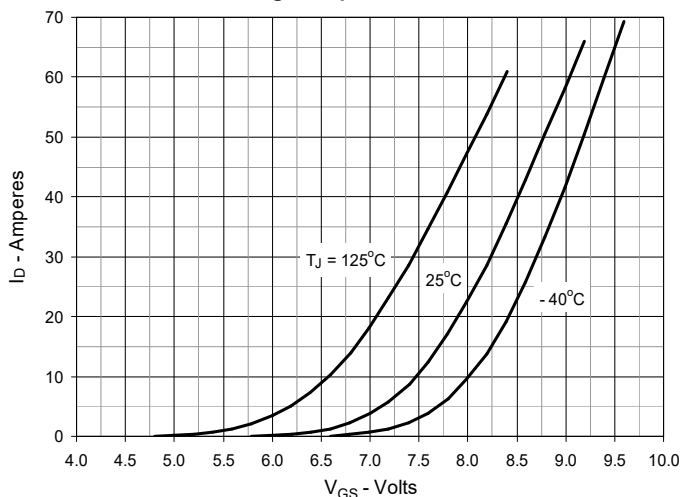

Fig. 8. Transconductance

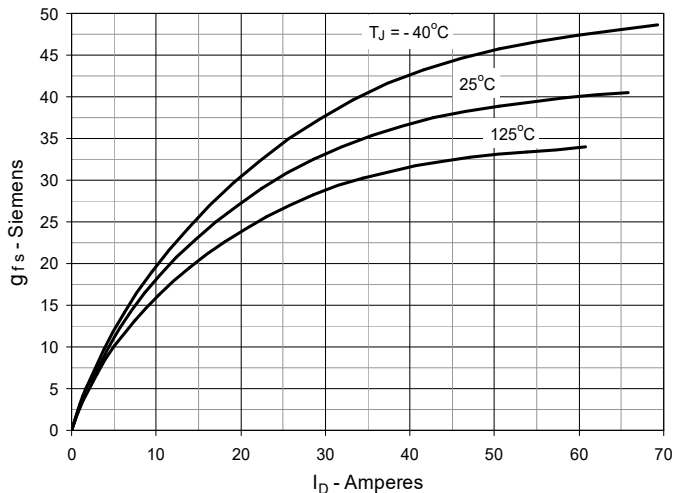

Fig. 9. Forward Voltage Drop of Intrinsic Diode

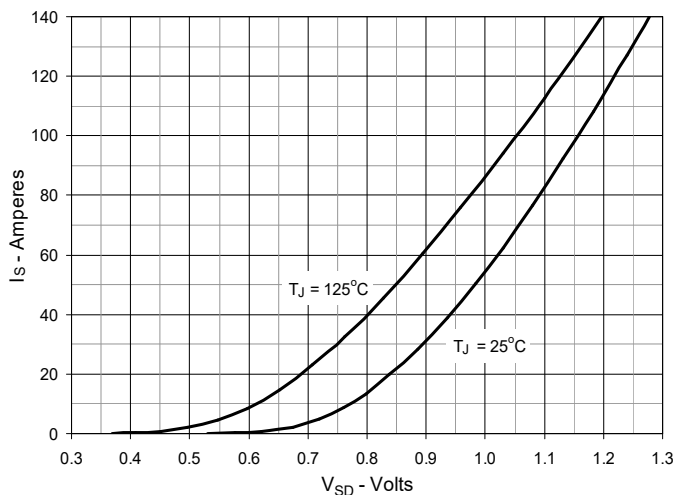

Fig. 10. Gate Charge

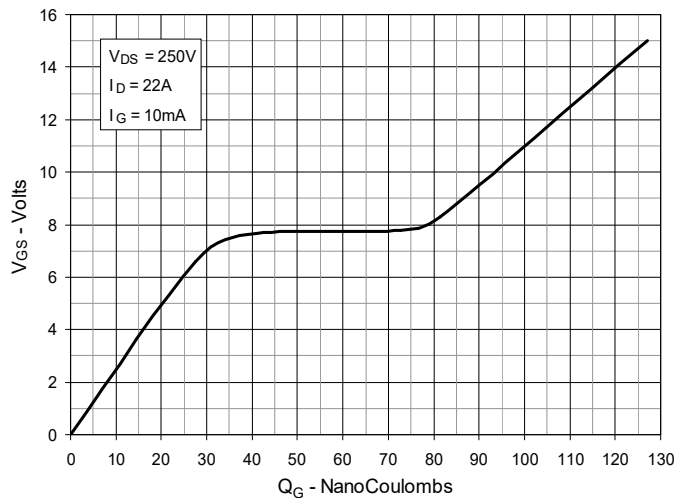

Fig. 11. Capacitance

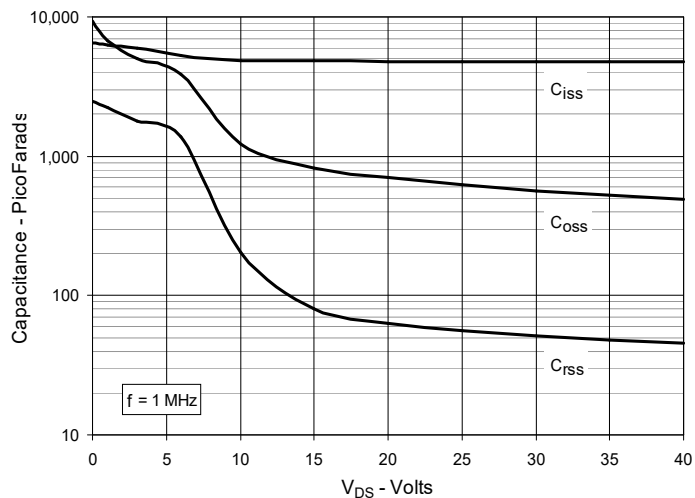

Fig. 12. Forward-Bias Safe Operating Area

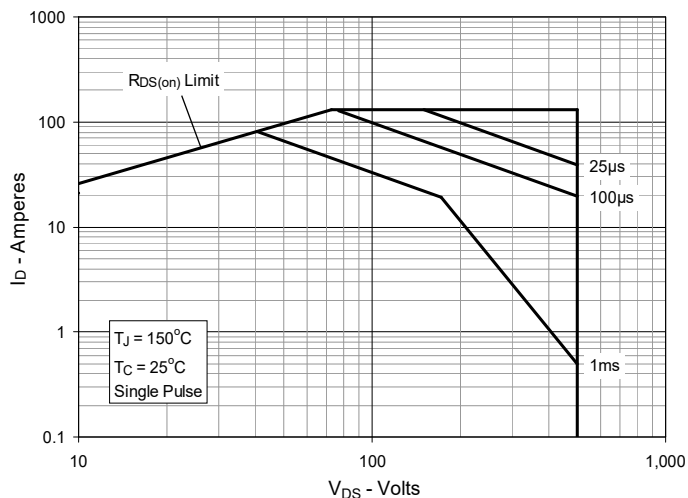
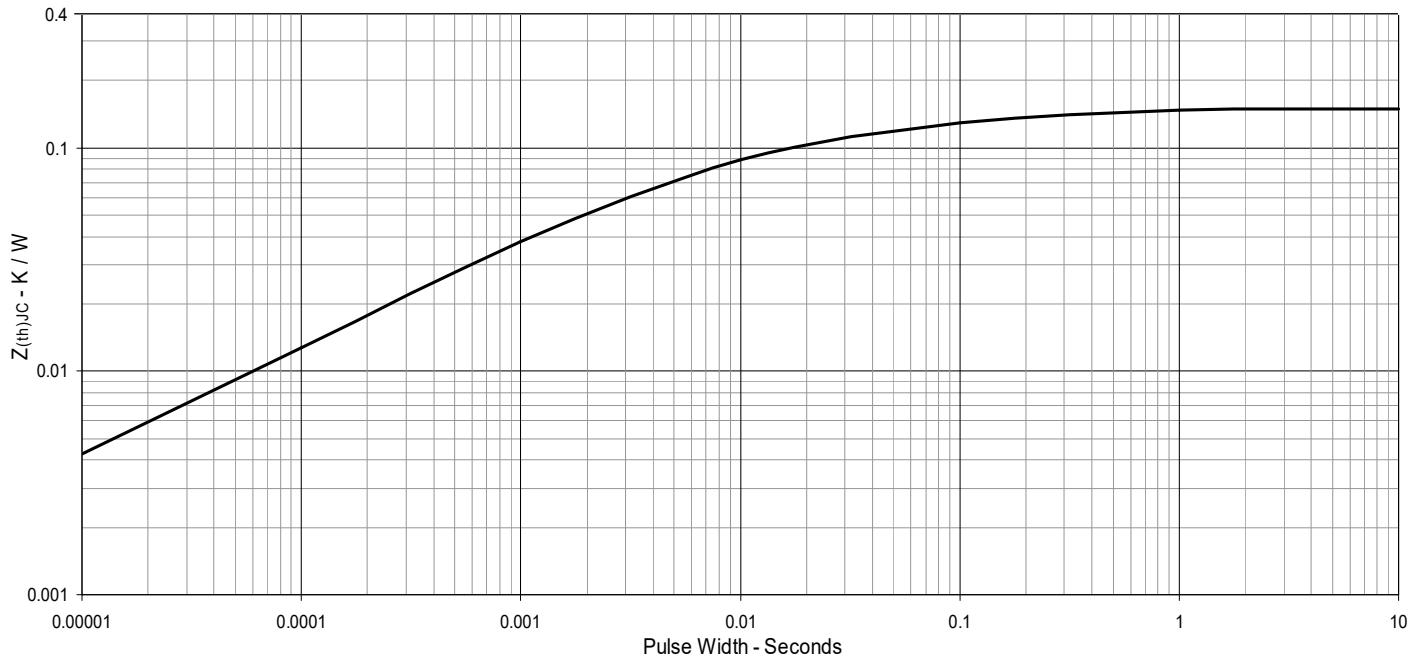
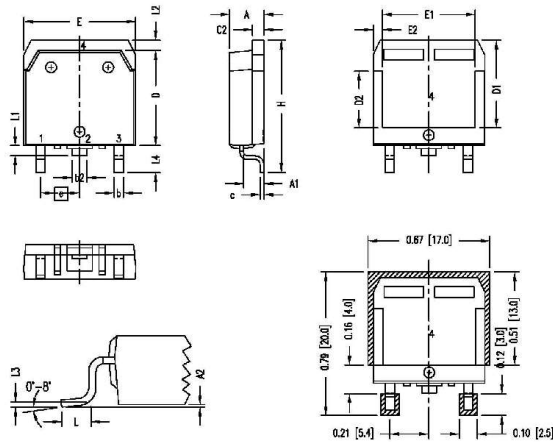

Fig. 13 Maximum Transient Thermal Impedance



TO-268 Outline



- 1 - Gate**
- 2,4 - Drain**
- 3 - Source**

SYMBOL	INCHES		MILLIMETERS	
	MIN	MAX	MIN	MAX
A	.193	.201	4.90	5.10
A1	.106	.114	2.70	2.90
A2	.001	.010	0.02	0.25
b	.045	.057	1.15	1.45
b2	.075	.083	1.90	2.10
C	.016	.026	0.40	0.65
C2	.057	.063	1.45	1.60
D	.543	.551	13.80	14.00
D1	.488	.500	12.40	12.70
D2	.320	.335	8.13	8.50
E	.624	.632	15.85	16.05
E1	.524	.535	13.30	13.60
E2	.045	.055	1.14	1.39
e	.215 BSC		5.45 BSC	
H	.736	.752	18.70	19.10
L	.094	.106	2.40	2.70
L1	.047	.055	1.20	1.40
L2	.039	.045	1.00	1.15
L3	.010 BSC		0.25 BSC	
L4	.150	.161	3.80	4.10

NOTE: ALL METAL SURFACE ARE MATTE PURE TIN PLATED EXCEPT TRIM AREA
Pd PLATING THICKNESS (4 - 20 um)

TO-247 Outline

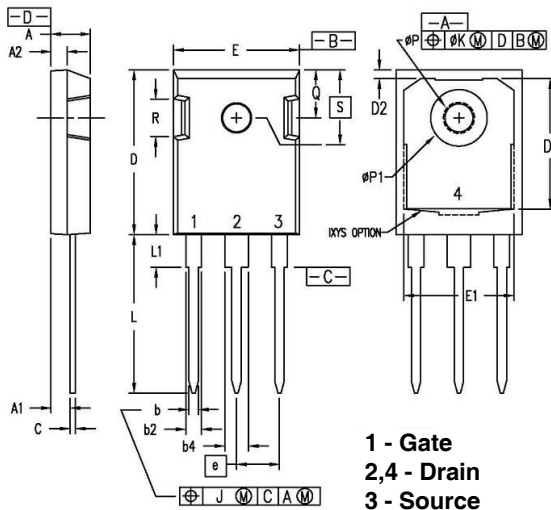

- 1 - Gate**
- 2,4 - Drain**
- 3 - Source**

SYM	INCHES		MILLIMETERS	
	MIN	MAX	MIN	MAX
A	.190	.205	4.83	5.21
A1	.090	.100	2.29	2.54
A2	.075	.085	1.91	2.16
b	.045	.055	1.14	1.40
b2	.075	.087	1.91	2.20
b4	.115	.126	2.92	3.20
C	.024	.031	0.61	0.80
D	.819	.840	20.80	21.34
D1	.650	.690	16.51	17.53
D2	.035	.050	0.89	1.27
E	.620	.635	15.75	16.13
E1	.545	.565	13.84	14.35
e	.215 BSC		5.45 BSC	
J	--	.010	--	0.25
K	--	.025	--	0.64
L	.780	.810	19.81	20.57
L1	.150	.170	3.81	4.32
ØP	.140	.144	3.55	3.65
ØP1	.275	.290	6.99	7.37
Q	.220	.244	5.59	6.20
R	.170	.190	4.32	4.83
S	.242 BSC		6.15 BSC	

NOTE: This drawing will meet all dimensions requirement of JEDEC outlines TO-247 AD (R-PSIP-F3)



Disclaimer Notice - Information furnished is believed to be accurate and reliable. However, users should independently evaluate the suitability of and test each product selected for their own applications. Littelfuse products are not designed for, and may not be used in, all applications. Read complete Disclaimer Notice at www.littelfuse.com/disclaimer-electronics.
