

PolarHV™ HiPerFET Power MOSFET

IXFB 82N60P

$V_{DSS} = 600 \text{ V}$
 $I_{D25} = 82 \text{ A}$
 $R_{DS(on)} \leq 75 \text{ m}\Omega$
 $t_{rr} \leq 200 \text{ ns}$

N-Channel Enhancement Mode
 Avalanche Rated
 Fast Intrinsic Diode



Symbol	Test Conditions	Maximum Ratings	
V_{DSS}	$T_J = 25^\circ\text{C}$ to 150°C	600	V
V_{DGR}	$T_J = 25^\circ\text{C}$ to 150°C ; $R_{GS} = 1 \text{ M}\Omega$	600	V
V_{GSS}	Continuous	± 30	V
V_{GSM}	Transient	± 40	V
I_{D25}	$T_C = 25^\circ\text{C}$	82	A
I_{DRMS}	External lead current limit	75	A
I_{DM}	$T_C = 25^\circ\text{C}$, pulse width limited by T_{JM}	200	A
I_{AR}	$T_C = 25^\circ\text{C}$	82	A
E_{AR}	$T_C = 25^\circ\text{C}$	100	mJ
E_{AS}	$T_C = 25^\circ\text{C}$	5	J
dv/dt	$I_S \leq I_{DM}$, $di/dt \leq 100 \text{ A}/\mu\text{s}$, $V_{DD} \leq V_{DSS}$, $T_J \leq 150^\circ\text{C}$, $R_G = 2 \Omega$	20	V/ns
P_D	$T_C = 25^\circ\text{C}$	1250	W
T_J		-55 ... +150	$^\circ\text{C}$
T_{JM}		150	$^\circ\text{C}$
T_{stg}		-55 ... +150	$^\circ\text{C}$
T_L	1.6 mm (0.062 in.) from case for 10 s	300	$^\circ\text{C}$
T_{SOLD}	Plastic body for 10 s	260	$^\circ\text{C}$
F_C	Mounting force	30..120/7.5...2.7	N/lb
Weight		10	g

PLUS264™ (IXFB)

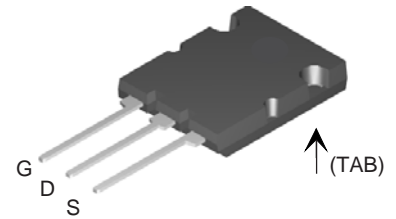

G = Gate D = Drain
 S = Source TAB = Drain

Features

- International standard packages
- Fast recovery diode
- Unclamped Inductive Switching (UIS) rated
- Low package inductance
 - easy to drive and to protect

Advantages

- Plus 264™ package for clip or spring
- Space savings
- High power density

Symbol	Test Conditions	Characteristic Values		
		Min.	Typ.	Max.
BV_{DSS}	$V_{GS} = 0 \text{ V}$, $I_D = 3 \text{ mA}$	600		V
$V_{GS(th)}$	$V_{DS} = V_{GS}$, $I_D = 8 \text{ mA}$	3.0		5.0 V
I_{GSS}	$V_{GS} = \pm 30 \text{ V}_{DC}$, $V_{DS} = 0$			$\pm 200 \text{ nA}$
I_{DSS}	$V_{DS} = V_{DSS}$ $V_{GS} = 0 \text{ V}$			25 μA 2000 μA
$R_{DS(on)}$	$V_{GS} = 10 \text{ V}$, $I_D = 0.5 I_{D25}$, Note 1			75 $\text{m}\Omega$

Symbol	Test Conditions	Characteristic Values ($T_J = 25^\circ\text{C}$, unless otherwise specified)		
		Min.	Typ.	Max.
g_{fs}	$V_{DS} = 20\text{ V}; I_D = 0.5 I_{D25}$, Note 1	50	80	S
C_{iss}	$V_{GS} = 0\text{ V}, V_{DS} = 25\text{ V}, f = 1\text{ MHz}$		23	nF
C_{oss}			1490	pF
C_{rss}			200	pF
$t_{d(on)}$	$V_{GS} = 10\text{ V}, V_{DS} = 0.5 V_{DSS}, I_D = 0.5 I_{D25}$ $R_G = 1\ \Omega$ (External)		28	ns
t_r			23	ns
$t_{d(off)}$			79	ns
t_f			24	ns
$Q_{g(on)}$	$V_{GS} = 10\text{ V}, V_{DS} = 0.5 V_{DSS}, I_D = 0.5 I_{D25}$		240	nC
Q_{gs}			96	nC
Q_{gd}			67	nC
R_{thJC}			0.10	$^\circ\text{C/W}$
R_{thCS}		0.13		$^\circ\text{C/W}$

Source-Drain Diode

Symbol	Test Conditions	Characteristic Values ($T_J = 25^\circ\text{C}$, unless otherwise specified)		
		Min.	Typ.	Max.
I_S	$V_{GS} = 0\text{ V}$			82 A
I_{SM}	Repetitive			200 A
V_{SD}	$I_F = I_S, V_{GS} = 0\text{ V}$, Note 1			1.5 V
t_{rr}	$I_F = 25\text{ A}, -di/dt = 100\text{ A}/\mu\text{s}$ $V_R = 100\text{ V}$			200 ns
Q_{RM}			0.6	μC
I_{RM}			6.0	A

Notes:

1. Pulse test, $t \leq 300\ \mu\text{s}$, duty cycle $d \leq 2\%$

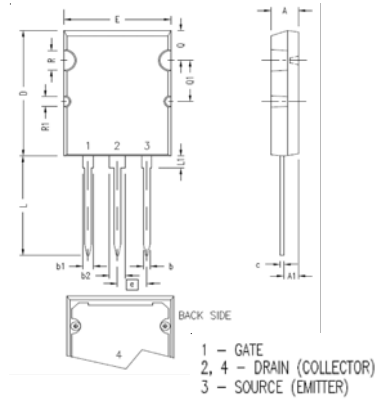
PLUS264™ (IXFB) Outline

SYM	INCHES		MILLIMETERS	
	MIN	MAX	MIN	MAX
A	.185	.209	4.70	5.31
A1	.102	.118	2.59	3.00
b	.037	.055	0.94	1.40
b1	.087	.102	2.21	2.59
b2	.110	.126	2.79	3.20
c	.017	.029	0.43	0.74
D	1.007	1.047	25.58	26.59
E	.760	.799	19.30	20.29
e	.215 BSC		5.46 BSC	
L	.779	.842	19.79	21.39
L1	.087	.102	2.21	2.59
Q	.240	.256	6.10	6.50
Q1	.330	.346	8.38	8.79
$\varnothing R$.155	.187	3.94	4.75
$\varnothing R1$.085	.093	2.16	2.36

**Fig. 1. Output Characteristics
@ 25°C**

**Fig. 2. Extended Output Characteristics
@ 25°C**

**Fig. 3. Output Characteristics
@ 125°C**

**Fig. 4. $R_{DS(on)}$ Normalized to $I_D = 41A$ Value
vs. Junction Temperature**

**Fig. 5. $R_{DS(on)}$ Normalized to $I_D = 41A$ Value
vs. Drain Current**

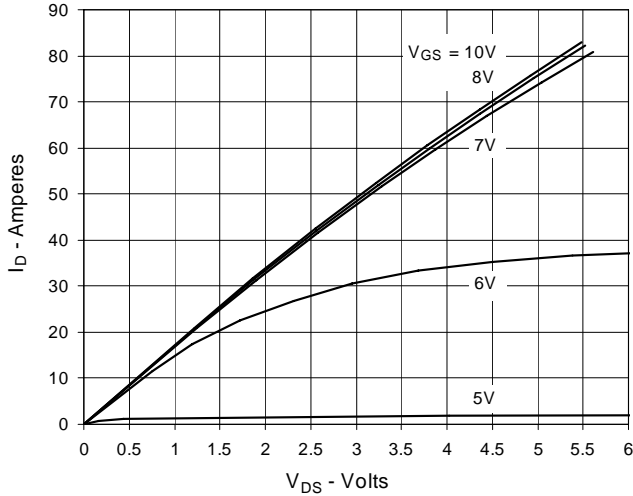
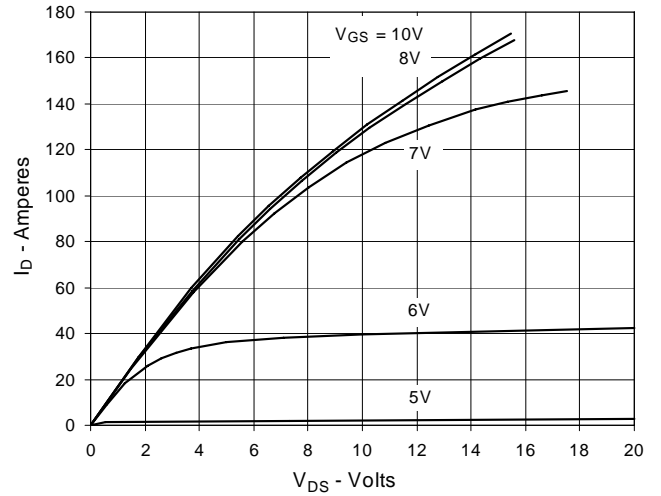
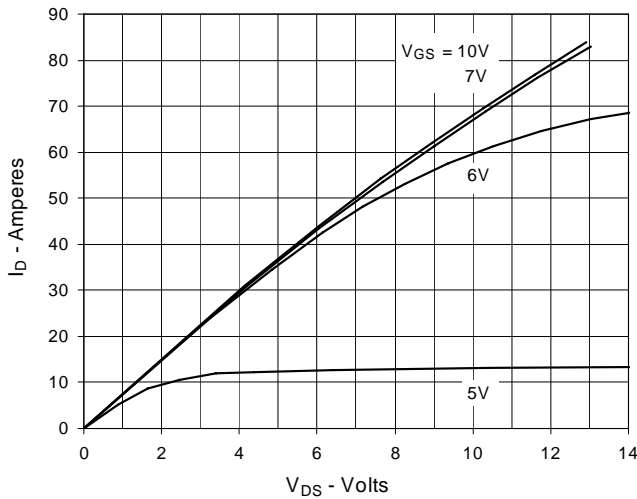
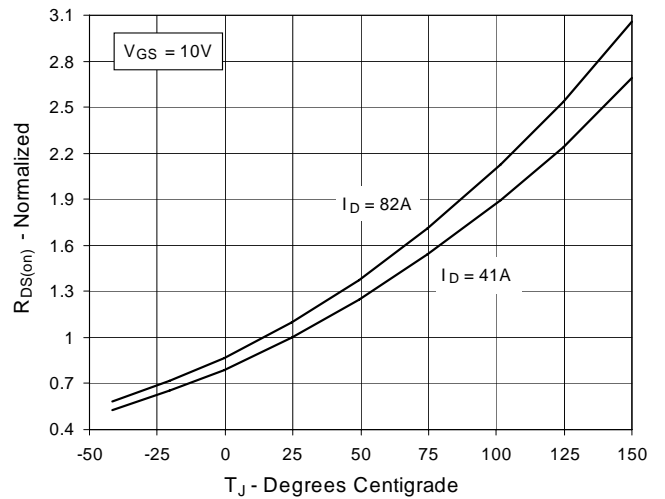
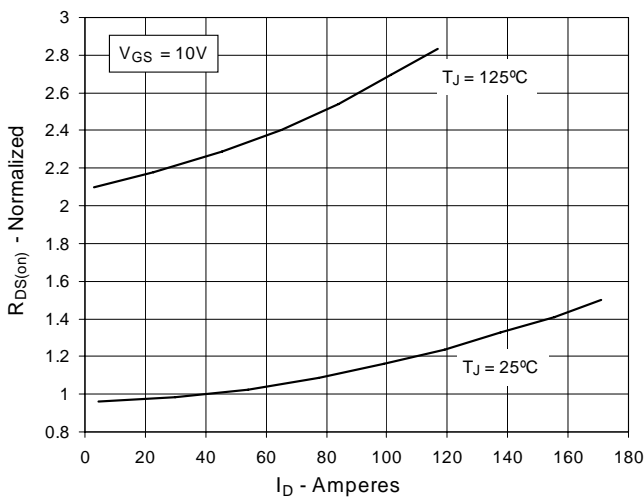
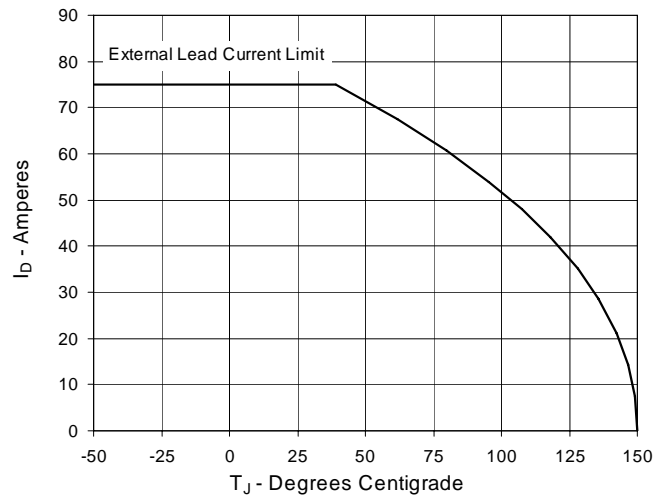
**Fig. 6. Maximum Drain Current vs.
Case Temperature**

Fig. 7. Input Admittance

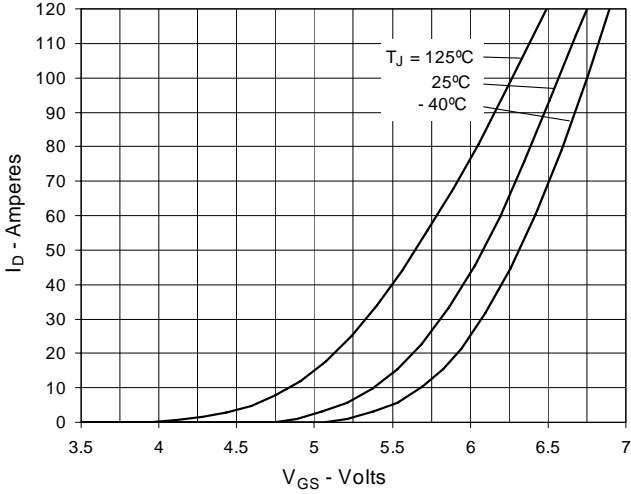

Fig. 8. Transconductance

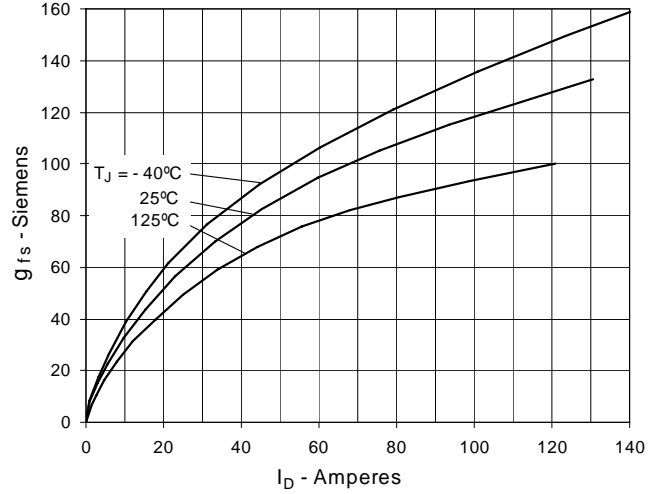

Fig. 9. Forward Voltage Drop of Intrinsic Diode

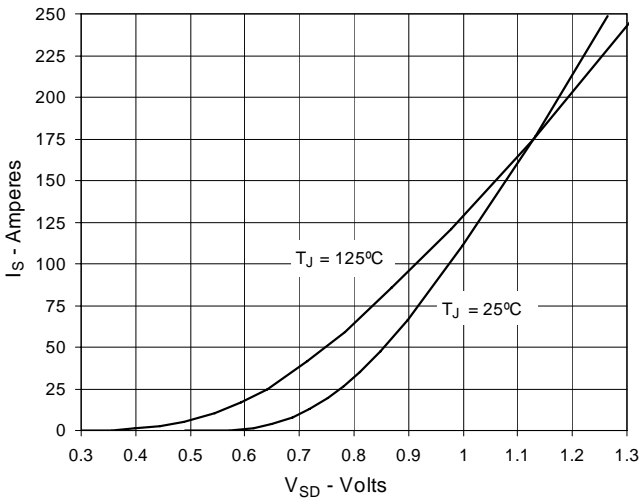

Fig. 10. Gate Charge

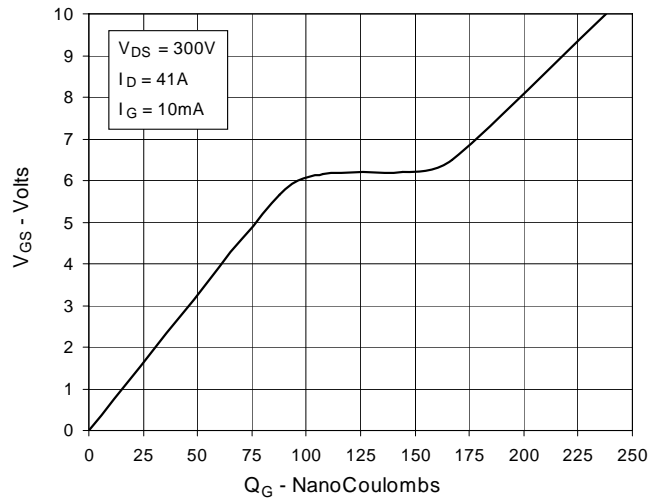

Fig. 11. Capacitance

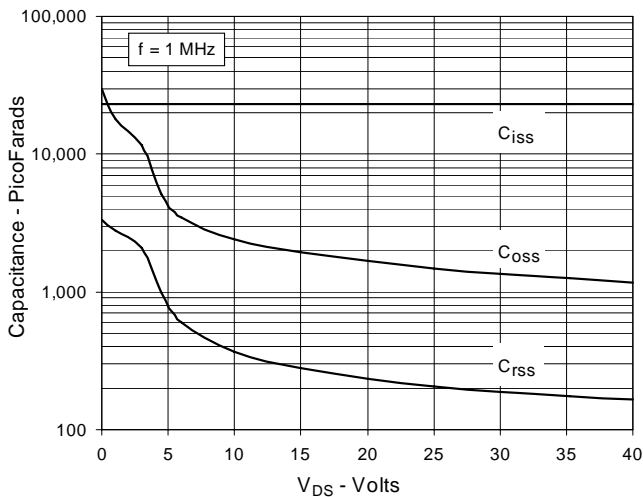

Fig. 12. Forward-Bias Safe Operating Area

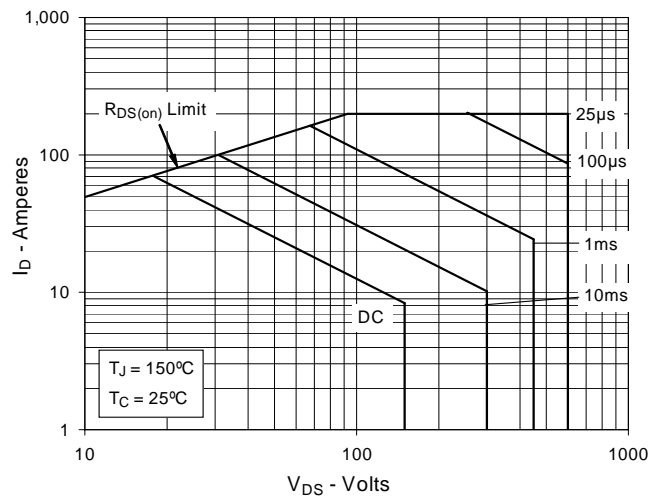
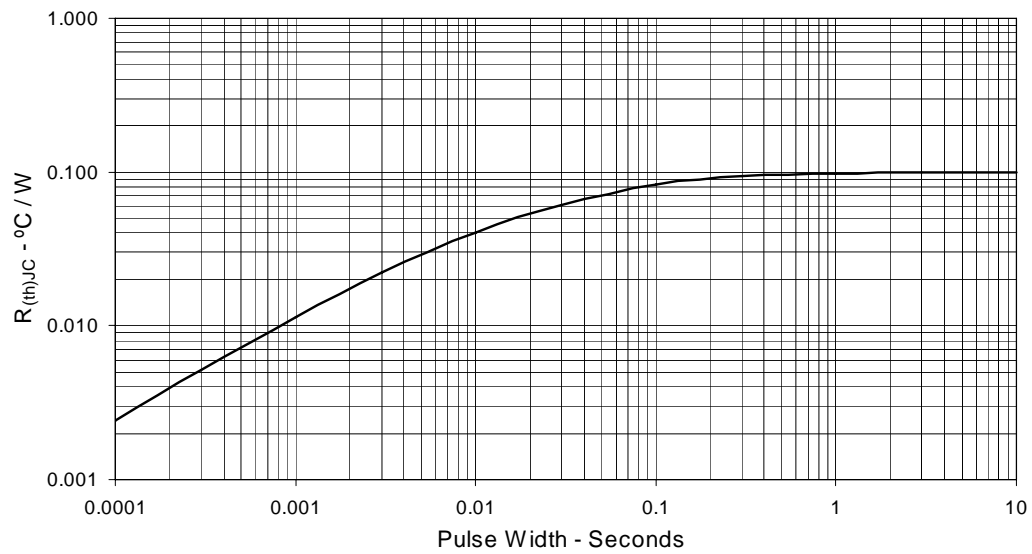

Fig. 13. Maximum Transient Thermal Resistance



Disclaimer Notice - Information furnished is believed to be accurate and reliable. However, users should independently evaluate the suitability of and test each product selected for their own applications. Littelfuse products are not designed for, and may not be used in, all applications. Read complete Disclaimer Notice at www.littelfuse.com/disclaimer-electronics.