

HiPerFET™ Power MOSFETs Q-Class

IXFH 21N50Q
IXFT 21N50Q

V_{DSS} = 500 V
I_{D25} = 21 A
R_{DS(on)} = 0.25 Ω

t_{rr} ≤ 250 ns

N-Channel Enhancement Mode
Avalanche Rated, Low Q_g, High dv/dt

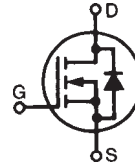

Symbol	Test Conditions	Maximum Ratings	
V _{DSS}	T _J = 25°C to 150°C	500	V
V _{DGR}	T _J = 25°C to 150°C; R _{GS} = 1 MΩ	500	V
V _{GS}	Continuous	±30	V
V _{GSM}	Transient	±40	V
I _{D25}	T _C = 25°C	21	A
I _{DM}	T _C = 25°C, pulse width limited by T _{JM}	84	A
I _{AR}	T _C = 25°C	21	A
E _{AR}	T _C = 25°C	30	mJ
E _{AS}		1.5	mJ
dv/dt	I _S ≤ I _{DM} , di/dt ≤ 100 A/μs, V _{DD} ≤ V _{DSS} , T _J ≤ 150°C, R _G = 2 Ω	15	V/ns
P _D	T _C = 25°C	280	W
T _J		-55 to +150	°C
T _{JM}		150	°C
T _{stg}		-55 to +150	°C
T _L	1.6 mm (0.063 in) from case for 10 s	300	°C
M _d	Mounting torque	1.13/10	Nm/lb.in.
Weight	TO-247	6	g
	TO-268	4	g

TO-247 AD (IXFH)

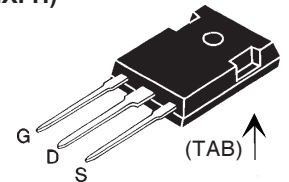

TO-268 (D3) (IXFT)

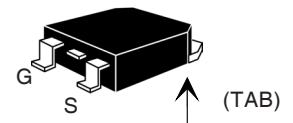

G = Gate D = Drain
S = Source TAB = Drain

Features

- ¹ IXYS advanced low Q_g process
- ¹ Low gate charge and capacitances
 - easier to drive
 - faster switching
- ¹ International standard packages
- ¹ Low R_{DS(on)}
- ¹ Rated for unclamped Inductive load switching (UIS) rated
- ¹ Molding epoxies meet UL 94 V-0 flammability classification

Advantages

- ¹ Easy to mount
- ¹ Space savings
- ¹ High power density

Symbol	Test Conditions	Characteristic Values (T _J = 25°C, unless otherwise specified)		
		min.	typ.	max.
V _{DSS}	V _{GS} = 0 V, I _D = 250 μA	500		V
V _{GS(th)}	V _{DS} = V _{GS} , I _D = 4 mA	2.5		V
I _{GSS}	V _{GS} = ±30 V _{DC} , V _{DS} = 0			±100 nA
I _{DSS}	V _{DS} = V _{DSS} V _{GS} = 0 V	T _J = 25°C		25 μA
		T _J = 125°C		1 mA
R _{DS(on)}	V _{GS} = 10 V, I _D = 0.5 I _{D25} Pulse test, t ≤ 300 μs, duty cycle d ≤ 2 %			0.25 Ω

Symbol	Test Conditions	Characteristic Values ($T_J = 25^\circ\text{C}$, unless otherwise specified)		
		min.	typ.	max.
g_{fs}	$V_{DS} = 20\text{ V}; I_D = 0.5 \cdot I_{D25}$, pulse test	14	21	S
C_{iss}	$V_{GS} = 0\text{ V}, V_{DS} = 25\text{ V}, f = 1\text{ MHz}$		3000	pF
C_{oss}			420	pF
C_{rss}			110	pF
$t_{d(on)}$	$V_{GS} = 10\text{ V}, V_{DS} = 0.5 \cdot V_{DSS}, I_D = 0.5 \cdot I_{D25}$ $R_G = 2.0\ \Omega$ (External),		25	ns
t_r			28	ns
$t_{d(off)}$			51	ns
t_f			12	ns
$Q_{g(on)}$	$V_{GS} = 10\text{ V}, V_{DS} = 0.5 \cdot V_{DSS}, I_D = 0.5 \cdot I_{D25}$		84	nC
Q_{gs}			20	nC
Q_{gd}			35	nC
R_{thJC}	(TO-247)			0.45 K/W
R_{thCK}			0.25	K/W

Source-Drain Diode		Characteristic Values ($T_J = 25^\circ\text{C}$, unless otherwise specified)		
Symbol	Test Conditions	min.	typ.	max.
I_S	$V_{GS} = 0\text{ V}$			21 A
I_{SM}	Repetitive; pulse width limited by T_{JM}			84 A
V_{SD}	$I_F = I_S, V_{GS} = 0\text{ V}$, Pulse test, $t \leq 300\ \mu\text{s}$, duty cycle $d \leq 2\%$			1.3 V
t_{rr}	$I_F = I_S, -di/dt = 100\text{ A}/\mu\text{s}, V_R = 100\text{ V}$			250 ns
Q_{RM}			0.85	μC
I_{RM}			8	A

TO-247 AD (IXFH) Outline

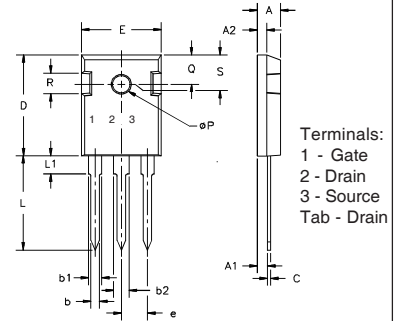

Dim.	Millimeter		Inches	
	Min.	Max.	Min.	Max.
A	4.7	5.3	.185	.209
A ₁	2.2	2.54	.087	.102
A ₂	2.2	2.6	.059	.098
b	1.0	1.4	.040	.055
b ₁	1.65	2.13	.065	.084
b ₂	2.87	3.12	.113	.123
C	.4	.8	.016	.031
D	20.80	21.46	.819	.845
E	15.75	16.26	.610	.640
e	5.20	5.72	0.205	0.225
L	19.81	20.32	.780	.800
L ₁		4.50		.177
ØP	3.55	3.65	.140	.144
Q	5.89	6.40	0.232	0.252
R	4.32	5.49	.170	.216
S		BSC	.242	BSC

TO-268 Outline

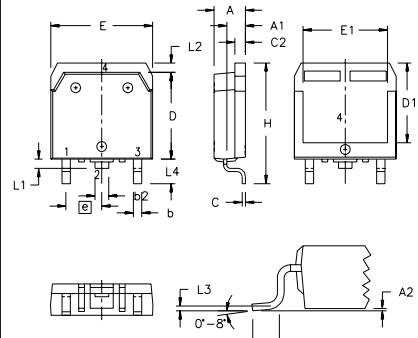

Terminals: 1 - Gate
2 - Drain
3 - Source
Tab - Drain

SYM	INCHES		MILLIMETERS	
	MIN	MAX	MIN	MAX
A	.193	.201	4.90	5.10
A ₁	.106	.114	2.70	2.90
A ₂	.001	.010	0.02	0.25
b	.045	.057	1.15	1.45
b ₂	.075	.083	1.90	2.10
C	.016	.026	0.40	0.65
C ₂	.057	.063	1.45	1.60
D	.543	.551	13.80	14.00
D ₁	.488	.500	12.40	12.70
E	.624	.632	15.85	16.05
E ₁	.524	.535	13.30	13.60
e	.215	BSC	5.45	BSC
H	.736	.752	18.70	19.10
L	.094	.106	2.40	2.70
L ₁	.047	.055	1.20	1.40
L ₂	.039	.045	1.00	1.15
L ₃	.010	BSC	0.25	BSC
L ₄	.150	.161	3.80	4.10

IXYS reserves the right to change limits, test conditions, and dimensions.

IXYS MOSFETs and IGBTs are covered by one or more of the following U.S. patents:

4,850,072	4,931,844	5,034,796	5,063,307	5,237,481	5,381,025	6,404,065B1	6,162,665	6,534,343	6,583,505
4,835,592	4,881,106	5,017,508	5,049,961	5,187,117	5,486,715	6,306,728B1	6,259,123B1	6,306,728B1	6,683,344

Fig. 1. Output Characteristics
@ 25°C

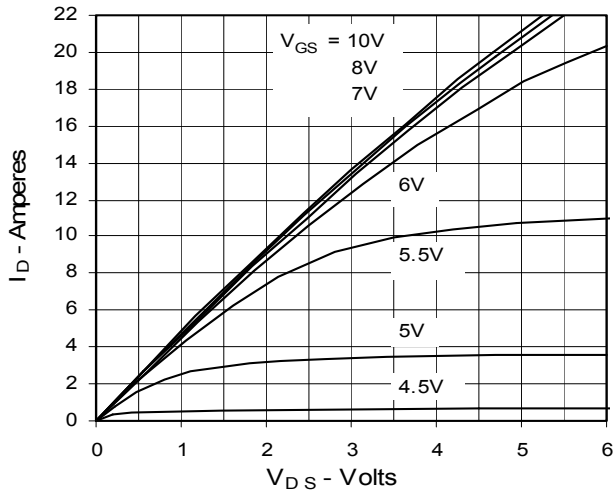

Fig. 2. Extended Output Characteristics
@ 25°C

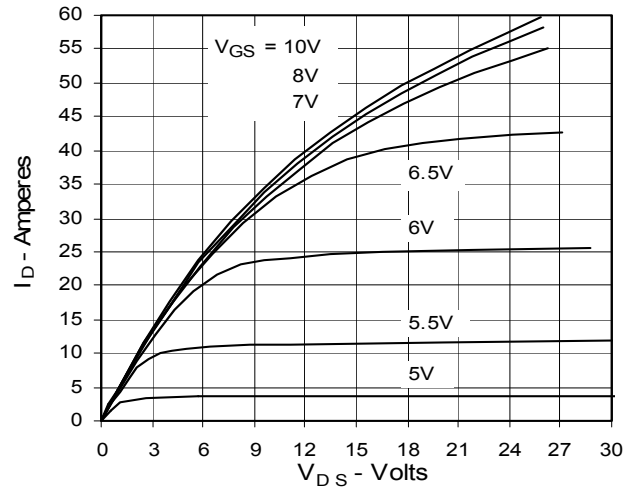

Fig. 3. Output Characteristics
@ 125°C

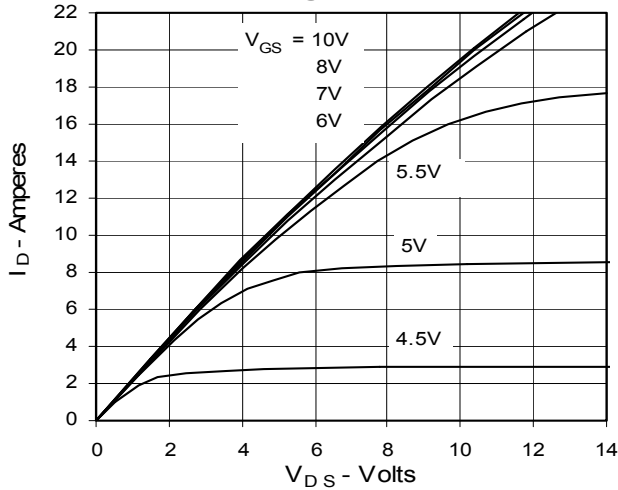

Fig. 4. $R_{DS(on)}$ Normalized to 0.5 I_{D25} Value vs. Junction Temperature

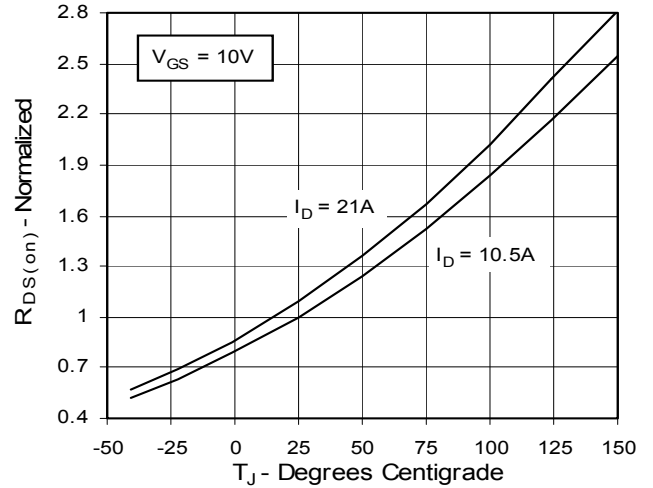

Fig. 5. $R_{DS(on)}$ Normalized to 0.5 I_{D25} Value vs. I_D

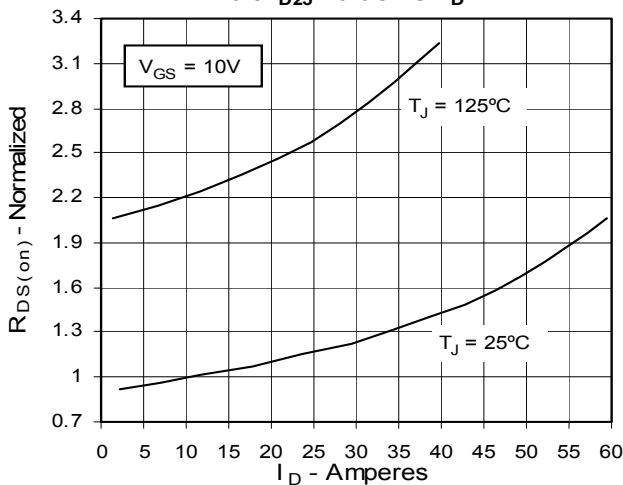

Fig. 6. Drain Current vs. Case Temperature

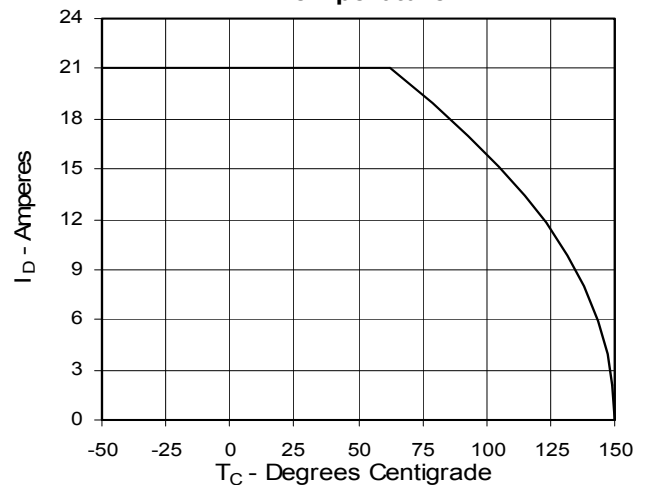

Fig. 7. Input Admittance

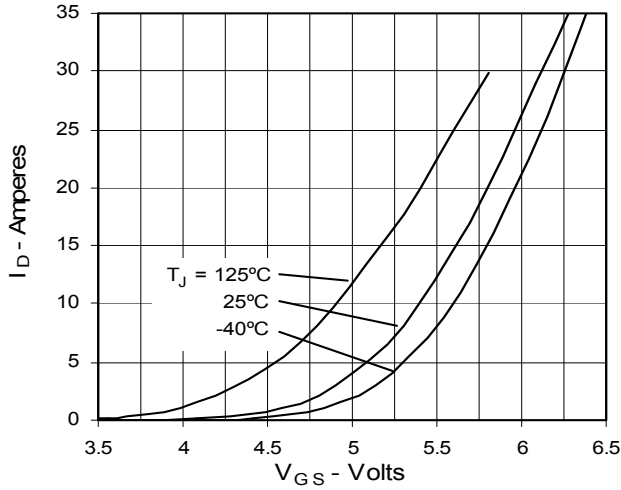

Fig. 8. Transconductance

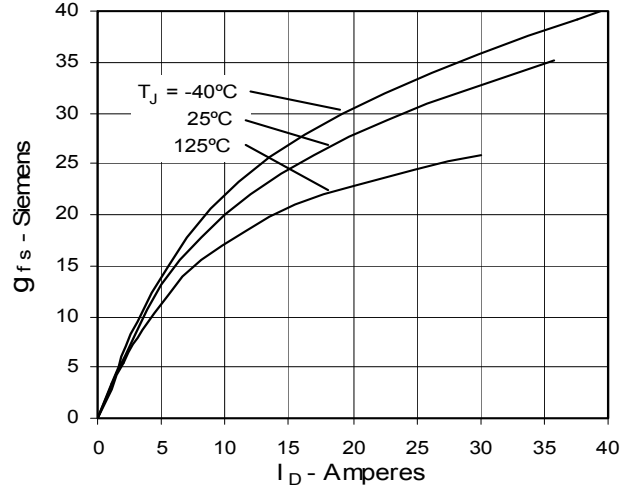

Fig. 9. Source Current vs. Source-To-Drain Voltage

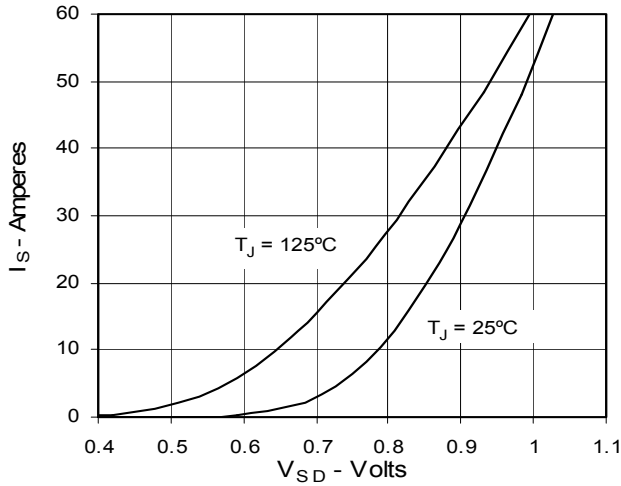

Fig. 10. Gate Charge

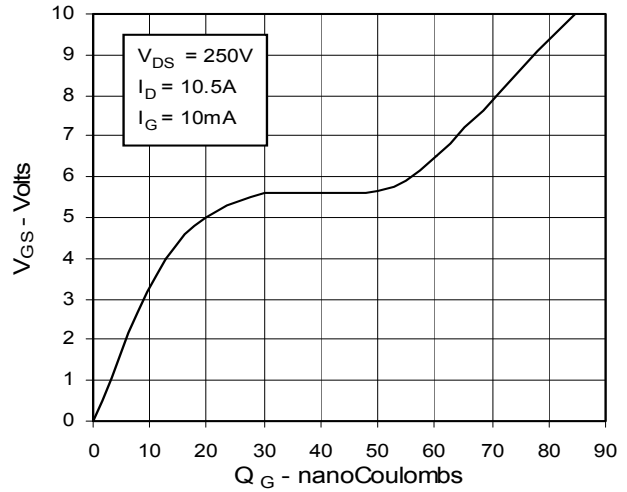

Fig. 11. Capacitance

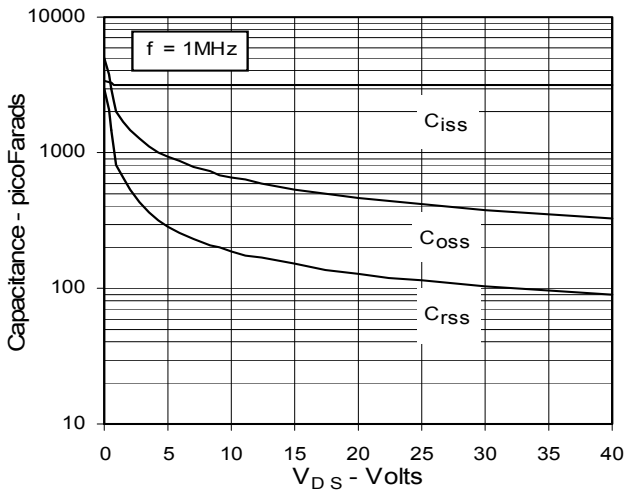
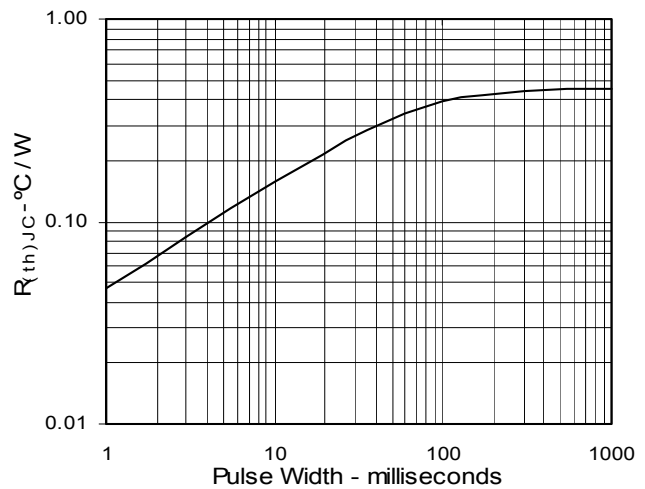

Fig. 12. Maximum Transient Thermal Resistance



IXYS reserves the right to change limits, test conditions, and dimensions.

IXYS MOSFETs and IGBTs are covered by one or more of the following U.S. patents:

4,850,072	4,931,844	5,034,796	5,063,307	5,237,481	5,381,025	6,404,065B1	6,162,665	6,534,343	6,583,505
4,835,592	4,881,106	5,017,508	5,049,961	5,187,117	5,486,715	6,306,728B1	6,259,123B1	6,306,728B1	6,683,344



Disclaimer Notice - Information furnished is believed to be accurate and reliable. However, users should independently evaluate the suitability of and test each product selected for their own applications. Littelfuse products are not designed for, and may not be used in, all applications. Read complete Disclaimer Notice at www.littelfuse.com/disclaimer-electronics.