

HiperFET™ Power MOSFETs

IXFK180N10 IXFX180N10

$V_{DSS} = 100V$
 $I_{D25} = 180A$
 $R_{DS(on)} \leq 8m\Omega$

Single MOSFET Die

N-Channel Enhancement Mode
 Avalanche Rated
 Fast Intrinsic Diode

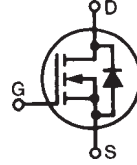

Symbol	Test Conditions	Maximum Ratings	
V_{DSS}	$T_J = 25^\circ C$ to $150^\circ C$	100	V
V_{DGR}	$T_J = 25^\circ C$ to $150^\circ C$, $R_{GS} = 1M\Omega$	100	V
V_{GSS}	Continuous	± 20	V
V_{GSM}	Transient	± 30	V
I_{D25}	$T_C = 25^\circ C$ (Chip Capabiltty)	180	A
I_{LRMS}	Leads Current Limit, RMS	160	A
I_{DM}	$T_C = 25^\circ C$, Pulse Width Limited by T_{JM}	720	A
I_A	$T_C = 25^\circ C$	180	A
E_{AS}	$T_C = 25^\circ C$	3	J
dV/dt	$I_S \leq I_{DM}$, $V_{DD} \leq V_{DSS}$, $T_J \leq 150^\circ C$	5	V/ns
P_D	$T_C = 25^\circ C$	560	W
T_J		-55 ... +150	$^\circ C$
T_{JM}		150	$^\circ C$
T_{stg}		-55 ... +150	$^\circ C$
T_L	1.6mm (0.062 in.) from Case for 10s	300	$^\circ C$
T_{SOLD}	Plastic Body for 10s	260	$^\circ C$
M_d	Mounting Force (PLUS247) Mounting Torque (TO-264)	20..120/4.5..27 1.13/10	N/lb. Nm/lb.in.
Weight	PLUS247	6	g
	TO-264	10	g

TO-264 (IXFK)

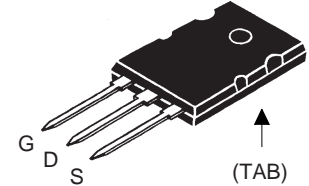

PLUS247 (IXFX)

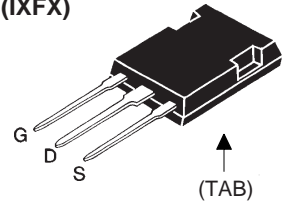

G = Gate D = Drain
 S = Source TAB = Drain

Features

- International Standard Packages
- High Current Handling Capability
- Avalanche Rated
- Low $R_{DS(on)}$ HDMOS™ Process
- Fast intrinsic diode
- Low Package Inductance

Advantages

- Easy to Mount
- Space Savings
- High Power Density

Applications

- DC-DC Converters
- Battery Chargers
- Switched-Mode and Resonant-Mode Power Supplies
- DC Choppers
- AC Motor Drives
- Temperature and Lighting Controls

Symbol	Test Conditions ($T_J = 25^\circ C$, Unless Otherwise Specified)	Characteristic Values		
		Min.	Typ.	Max.
BV_{DSS}	$V_{GS} = 0V$, $I_D = 3mA$	100		V
$V_{GS(th)}$	$V_{DS} = V_{GS}$, $I_D = 8mA$	2.0		V
I_{GSS}	$V_{GS} = \pm 20V$, $V_{DS} = 0V$			± 100 nA
I_{DSS}	$V_{DS} = V_{DSS}$ $V_{GS} = 0V$ $T_J = 125^\circ C$			100 μA 2 mA
$R_{DS(on)}$	$V_{GS} = 10V$, $I_D = 0.5 \cdot I_{D25}$, Note 1			8 m Ω

Symbol	Test Conditions ($T_J = 25^\circ\text{C}$, Unless Otherwise Specified)	Characteristic Values		
		Min.	Typ.	Max.
g_{fs}	$V_{DS} = 10\text{V}$, $I_D = 60\text{A}$, Note 1	45	76	S
C_{iss}	$V_{GS} = 0\text{V}$, $V_{DS} = 25\text{V}$, $f = 1\text{MHz}$		10.90	nF
C_{oss}			3.55	nF
C_{rss}			1.94	nF
$t_{d(on)}$	Resistive Switching Times $V_{GS} = 10\text{V}$, $V_{DS} = 0.5 \cdot V_{DSS}$, $I_D = 0.5 \cdot I_{D25}$ $R_G = 1\Omega$ (External)		50	ns
t_r			90	ns
$t_{d(off)}$			140	ns
t_f			65	ns
$Q_{g(on)}$		$V_{GS} = 10\text{V}$, $V_{DS} = 0.5 \cdot V_{DSS}$, $I_D = 0.5 \cdot I_{D25}$		390
Q_{gs}			55	nC
Q_{gd}			195	nC
R_{thJC}			0.22	$^\circ\text{C/W}$
R_{thCS}		0.15		$^\circ\text{C/W}$

Source-Drain Diode

Symbol	Test Conditions ($T_J = 25^\circ\text{C}$, Unless Otherwise Specified)	Characteristic Values		
		Min.	Typ.	Max.
I_S	$V_{GS} = 0\text{V}$			180 A
I_{SM}	Repetitive, Pulse Width Limited by T_{JM}			720 A
V_{SD}	$I_F = 100\text{A}$, $V_{GS} = 0\text{V}$, Note 1			1.5 V
t_{rr}	$I_F = 90\text{A}$, $-di/dt = 100\text{A}/\mu\text{s}$ $V_R = 50\text{V}$, $V_{GS} = 0\text{V}$		1.1	250 ns
Q_{RM}				μC
I_{RM}			13	A

Note 1: Pulse Test, $t \leq 300\mu\text{s}$; Duty Cycle, $d \leq 2\%$.

TO-264 (IXFK) Outline



1 - GATE
2, 4 - DRAIN (COLLECTOR)
3 - SOURCE (EMITTER)

SYM	INCHES		MILLIMETERS	
	MIN	MAX	MIN	MAX
A	.185	.209	4.70	5.31
A1	.102	.118	2.59	3.00
b	.037	.055	0.94	1.40
b1	.087	.102	2.21	2.59
b2	.110	.126	2.79	3.20
c	.017	.029	0.43	0.74
D	1.007	1.047	25.58	26.59
E	.760	.799	19.30	20.29
e	.215BSC		5.46 BSC	
J	.000	.010	0.00	0.25
K	.000	.010	0.00	0.25
L	.779	.842	19.79	21.39
L1	.087	.102	2.21	2.59
$\varnothing P$.122	.138	3.10	3.51
Q	.240	.256	6.10	6.50
Q1	.330	.346	8.38	8.79
$\varnothing R$.155	.187	3.94	4.75
$\varnothing R1$.085	.093	2.16	2.36
S	.243	.253	6.17	6.43

PLUS 247™ (IXFX) Outline

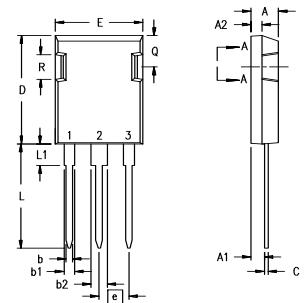

Terminals: 1 - Gate
2 - Drain (Collector)
3 - Source (Emitter)
4 - Drain (Collector)

Dim.	Millimeter		Inches	
	Min.	Max.	Min.	Max.
A	4.83	5.21	.190	.205
A ₁	2.29	2.54	.090	.100
A ₂	1.91	2.16	.075	.085
b	1.14	1.40	.045	.055
b ₁	1.91	2.13	.075	.084
b ₂	2.92	3.12	.115	.123
C	0.61	0.80	.024	.031
D	20.80	21.34	.819	.840
E	15.75	16.13	.620	.635
e	5.45 BSC		.215 BSC	
L	19.81	20.32	.780	.800
L1	3.81	4.32	.150	.170
Q	5.59	6.20	.220	0.244
R	4.32	4.83	.170	.190

IXYS Reserves the Right to Change Limits, Test Conditions, and Dimensions.

IXYS MOSFETs and IGBTs are covered by one or more of the following U.S. patents:	4,835,592	4,931,844	5,049,961	5,237,481	6,162,665	6,404,065 B1	6,683,344	6,727,585	7,005,734 B2	7,157,338B2
	4,850,072	5,017,508	5,063,307	5,381,025	6,259,123 B1	6,534,343	6,710,405 B2	6,759,692	7,063,975 B2	
	4,881,106	5,034,796	5,187,117	5,486,715	6,306,728 B1	6,583,505	6,710,463	6,771,478 B2	7,071,537	

Fig. 1. Output Characteristics @ 25°C

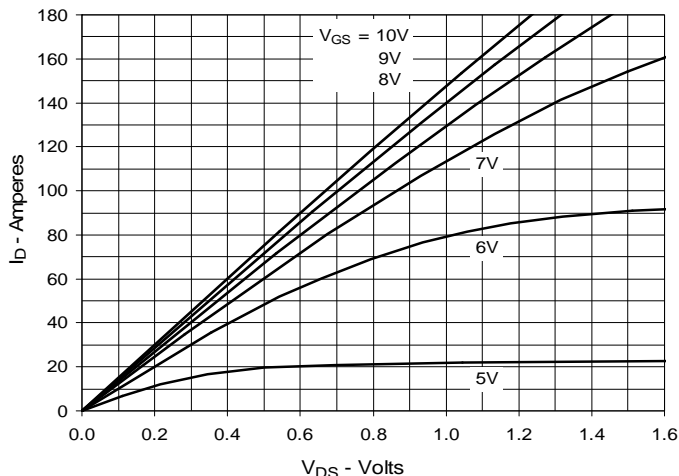

Fig. 2. Extended Output Characteristics @ 25°C

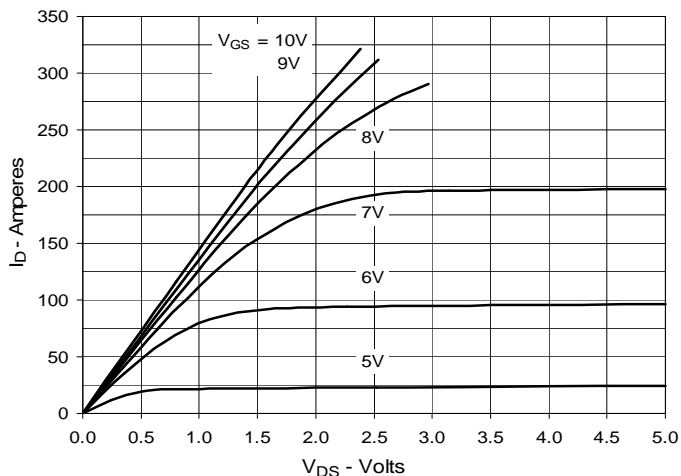

Fig. 3. Output Characteristics @ 125°C

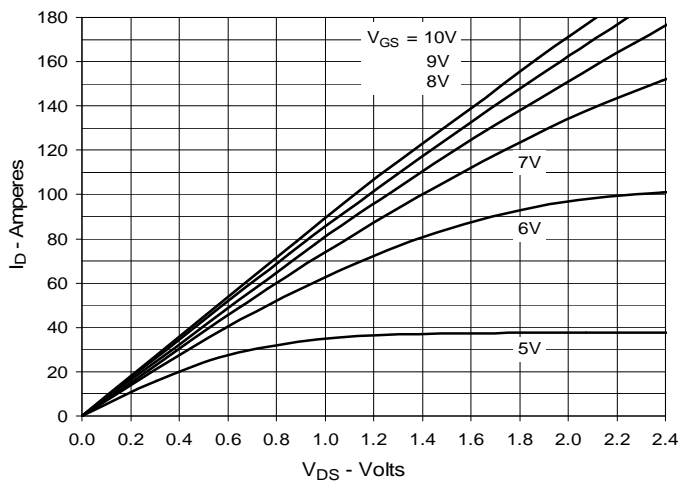

Fig. 4. $R_{DS(on)}$ Normalized to $I_D = 90A$ Value vs. Junction Temperature

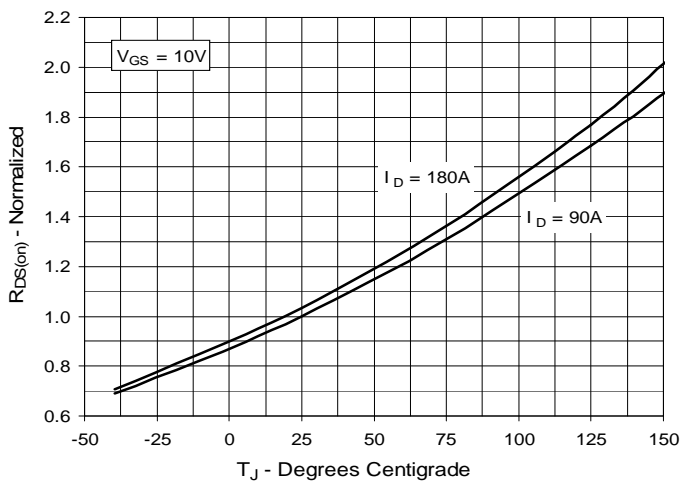

Fig. 5. $R_{DS(on)}$ Normalized to $I_D = 90A$ Value vs. Drain Current

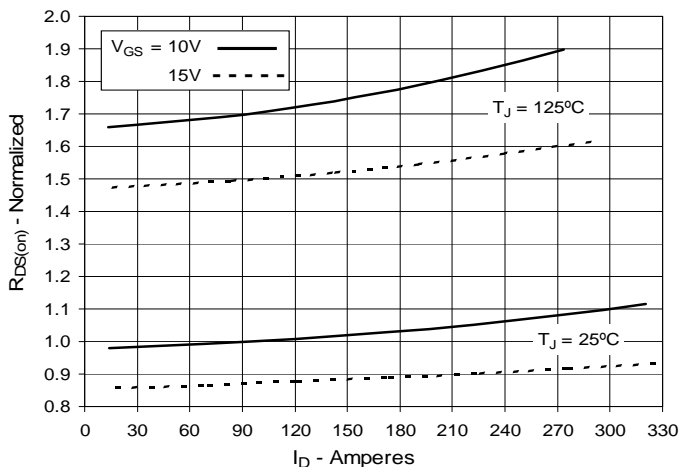

Fig. 6. Maximum Drain Current vs. Case Temperature

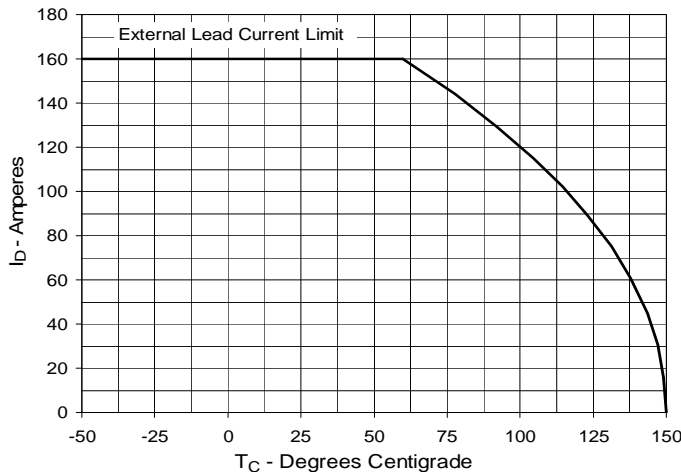

Fig. 7. Input Admittance

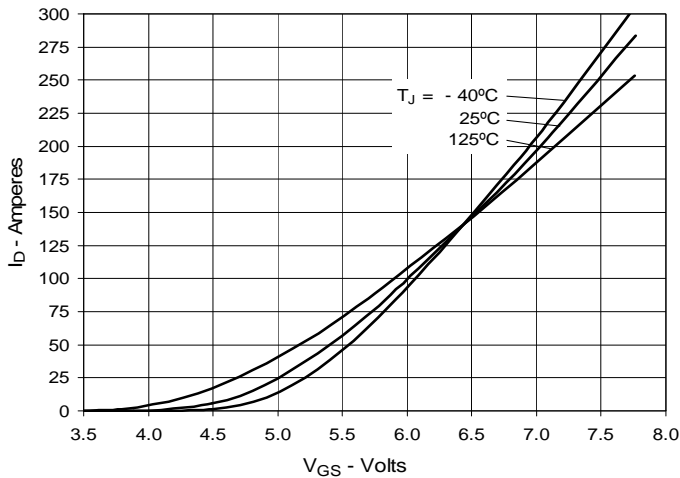

Fig. 8. Transconductance

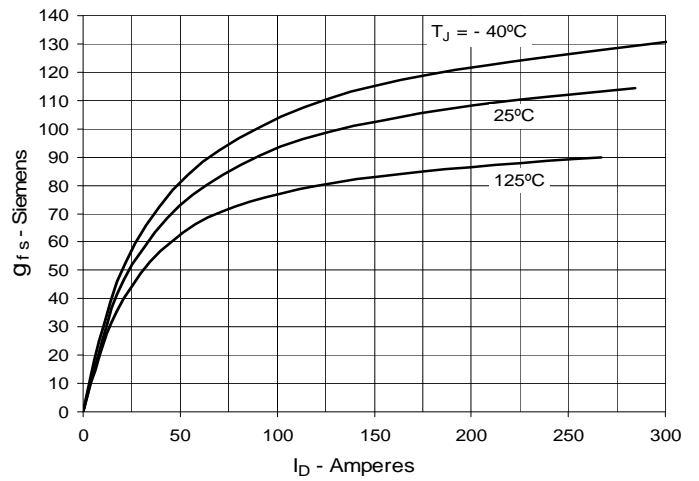

Fig. 9. Forward Voltage Drop of Intrinsic Diode

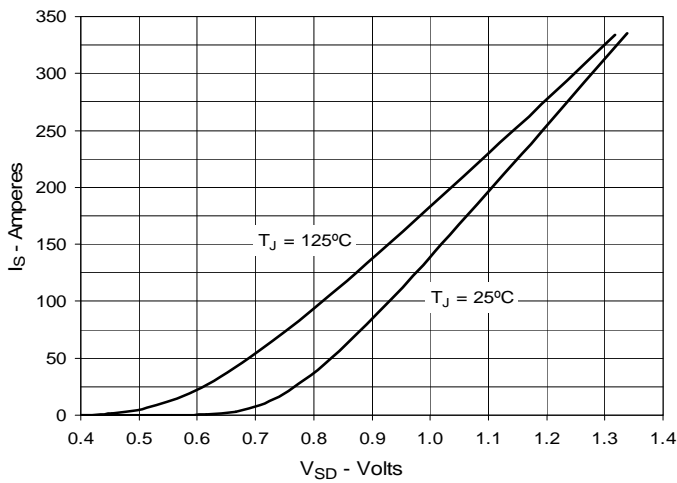

Fig. 10. Gate Charge

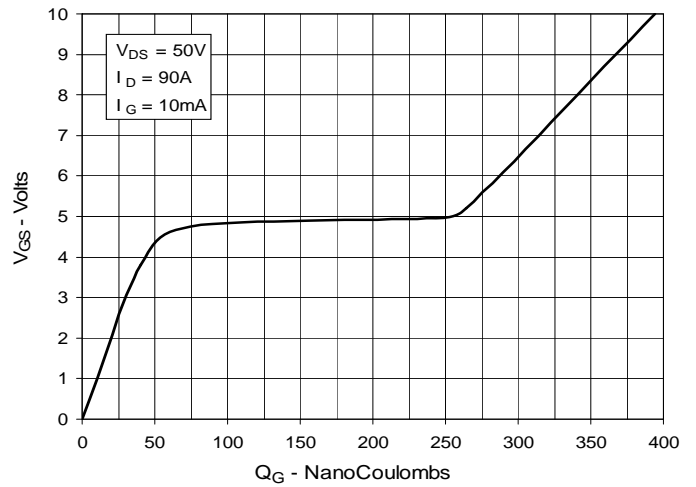

Fig. 11. Capacitance

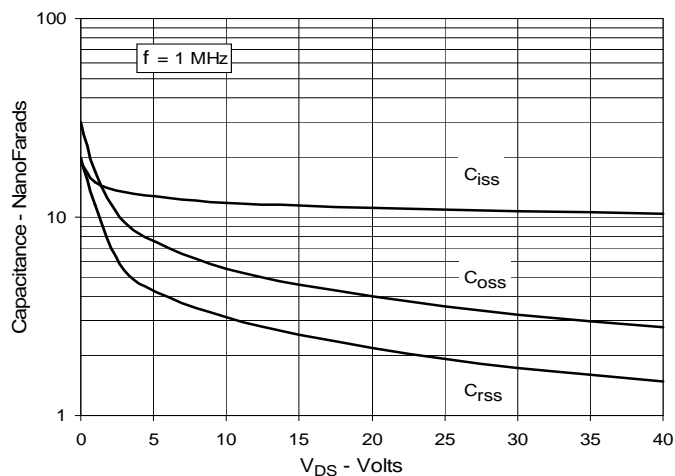

Fig. 12. Maximum Transient Thermal Impedance

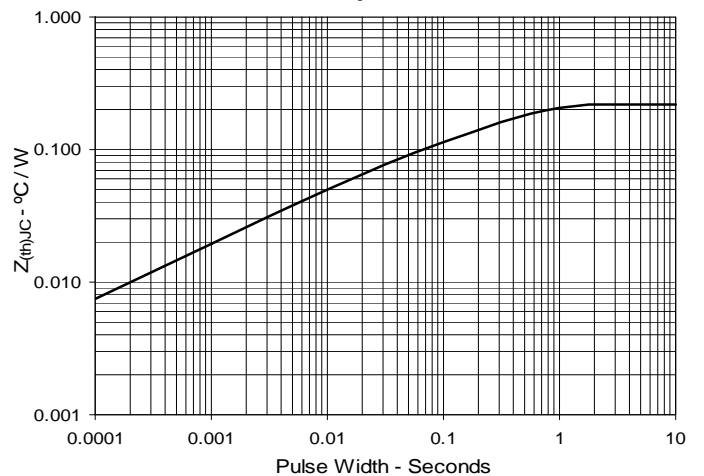

Fig. 13. Forward-Bias Safe Operating Area
@ $T_C = 25^\circ\text{C}$

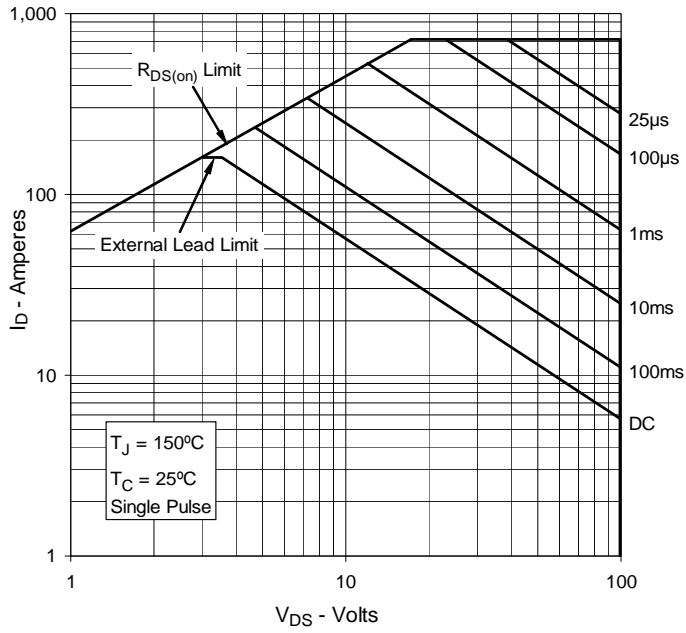
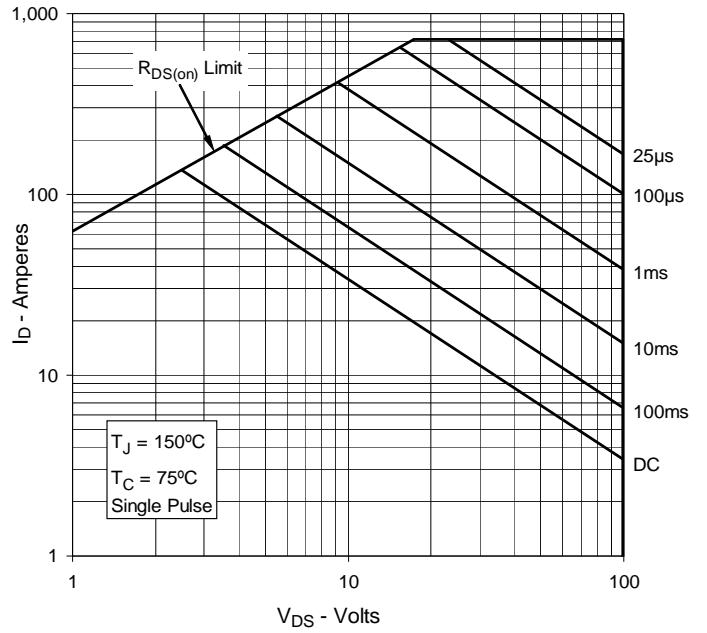

Fig. 14. Forward-Bias Safe Operating Area
@ $T_C = 75^\circ\text{C}$





Disclaimer Notice - Information furnished is believed to be accurate and reliable. However, users should independently evaluate the suitability of and test each product selected for their own applications. Littelfuse products are not designed for, and may not be used in, all applications. Read complete Disclaimer Notice at www.littelfuse.com/disclaimer-electronics.