

HiPerFET™ Power MOSFET Q2-Class

IXFR14N100Q2

N-Channel Enhancement Mode
Avalanche Rated, High dv/dt, Low Q_g
Low intrinsic R_g, low t_{rr}

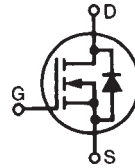

$$\begin{aligned} V_{DSS} &= 1000V \\ I_{D25} &= 9.5A \\ R_{DS(on)} &\leq 1.1\Omega \\ t_{rr} &\leq 300ns \end{aligned}$$

Symbol	Test Conditions	Maximum Ratings	
V _{DSS}	T _J = 25°C to 150°C	1000	V
V _{DGR}	T _J = 25°C to 150°C, R _{GS} = 1MΩ	1000	V
V _{GSS}	Continuous	± 30	V
V _{GSM}	Transient	± 40	V
I _{D25}	T _C = 25°C	9.5	A
I _{DM}	T _C = 25°C, Pulse Width Limited by T _{JM}	56	A
I _A	T _C = 25°C	14	A
E _{AS}	T _C = 25°C	2.5	J
dv/dt	I _S ≤ I _{DM} , V _{DD} ≤ V _{DSS} , T _J ≤ 150°C	20	V/ns
P _D	T _C = 25°C	200	W
T _J		-55 ... +150	°C
T _{JM}		150	°C
T _{stg}		-55 ... +150	°C
T _L	Maximum Lead Temperature for Soldering	300	°C
T _{SOLD}	Plastic Body for 10s	260	°C
V _{ISOL}	50/60 Hz, RMS, 1 minute	2500	V~
F _C	Mounting Force	20..120/4.5..27	N/lb.
Weight		5	g

ISOPLUS247
E153432

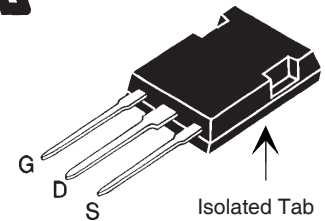

G = Gate D = Drain
S = Source

Features

- Double Metal Process for Low Gate Resistance
- International Standard Package
- Epoxy Meet UL 94 V-0, Flammability Classification
- Low R_{ds(on)}, Low Q_g
- Avalanche Energy and Current Rated
- Fast Intrinsic Rectifier

Applications

- DC-DC Converters
- Switched-Mode and Resonant-Mode Power Supplies, >500kHz Switching
- DC Choppers
- Pulse Generation
- Laser Drivers

Advantages

- Easy to Mount
- Space Savings
- High Power Density

Symbol	Test Conditions (T _J = 25°C, Unless Otherwise Specified)	Characteristic Values		
		Min.	Typ.	Max.
BV _{DSS}	V _{GS} = 0V, I _D = 250μA	1000		V
V _{GS(th)}	V _{DS} = V _{GS} , I _D = 4mA	3.0		5.5 V
I _{GSS}	V _{GS} = ± 30V, V _{DS} = 0V			± 200 nA
I _{DSS}	V _{DS} = V _{DSS} V _{GS} = 0V T _J = 125°C			25 μA 1 mA
R _{DS(on)}	V _{GS} = 10V, I _D = 7A, Note 1			1.1 Ω

Symbol	Test Conditions ($T_J = 25^\circ\text{C}$ Unless Otherwise Specified)	Characteristic Values		
		Min.	Typ.	Max.
g_{fs}	$V_{DS} = 10\text{V}, I_D = 7\text{A}, \text{Note 1}$	10	14	S
C_{iss}	$V_{GS} = 0\text{V}, V_{DS} = 25\text{V}, f = 1\text{MHz}$		2800	pF
C_{oss}			287	pF
C_{rss}			100	pF
$t_{d(on)}$	Resistive Switching Times $V_{GS} = 10\text{V}, V_{DS} = 0.5 \cdot V_{DSS}, I_D = 7\text{A}$ $R_G = 2\Omega$ (External)		12	ns
t_r			10	ns
$t_{d(off)}$			28	ns
t_f			12	ns
$Q_{g(on)}$	$V_{GS} = 10\text{V}, V_{DS} = 0.5 \cdot V_{DSS}, I_D = 7\text{A}$		83	nC
Q_{gs}			20	nC
Q_{gd}			40	nC
R_{thJC}				0.62 $^\circ\text{C/W}$
R_{thCS}		0.15		$^\circ\text{C/W}$

Source-Drain Diode		Characteristic Values		
$T_J = 25^\circ\text{C}$ Unless Otherwise Specified)		Min.	Typ.	Max.
I_S	$V_{GS} = 0\text{V}$			14 A
I_{SM}	Repetitive, Pulse Width Limited by T_{JM}			56 A
V_{SD}	$I_F = I_S, V_{GS} = 0\text{V}, \text{Note 1}$			1.5 V
t_{rr}	$I_F = 14\text{A}, -di/dt = 100\text{A}/\mu\text{s}$ $V_R = 100\text{V}, V_{GS} = 0\text{V}$			300 ns
Q_{RM}			0.8	μC
I_{RM}			7	A

ISOPLUS247 (IXFR) Outline

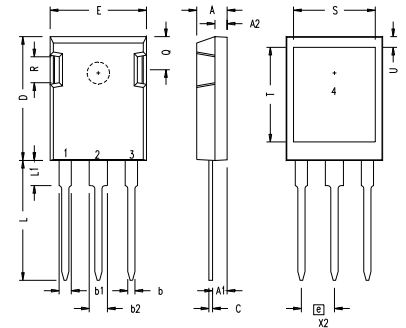

SYM	INCHES		MILLIMETERS	
	MIN	MAX	MIN	MAX
A	.190	.205	4.83	5.21
A1	.090	.100	2.29	2.54
A2	.075	.085	1.91	2.16
b	.045	.055	1.14	1.40
b1	.075	.084	1.91	2.13
b2	.115	.123	2.92	3.12
C	.024	.031	0.61	0.80
D	.819	.840	20.80	21.34
E	.620	.635	15.75	16.13
e	.215 BSC		5.45 BSC	
L	.780	.800	19.81	20.32
L1	.150	.170	3.81	4.32
Q	.220	.244	5.59	6.20
R	.170	.190	4.32	4.83
S	.520	.540	13.21	13.72
T	.620	.640	15.75	16.26
U	.065	.080	1.65	2.03

- 1 - GATE
- 2 - DRAIN (COLLECTOR)
- 3 - SOURCE (EMITTER)
- 4 - NO CONNECTION

NOTE: This drawing will meet all dimensions requirement of JEDEC outline TO-247AD except screw hole.

Note 1: Pulse test, $t \leq 300\mu\text{s}$; duty cycle, $d \leq 2\%$.

IXYS Reserves the Right to Change Limits, Test Conditions, and Dimensions.

IXYS MOSFETs and IGBTs are covered by one or more of the following U.S. patents:	4,835,592	4,931,844	5,049,961	5,237,481	6,162,665	6,404,065 B1	6,683,344	6,727,585	7,005,734 B2	7,157,338B2
	4,850,072	5,017,508	5,063,307	5,381,025	6,259,123 B1	6,534,343	6,710,405 B2	6,759,692	7,063,975 B2	
	4,881,106	5,034,796	5,187,117	5,486,715	6,306,728 B1	6,583,505	6,710,463	6,771,478 B2	7,071,537	

**Fig. 1. Output Characteristics
@ 25°C**

**Fig. 2. Extended Output Characteristics
@ 25°C**

**Fig. 3. Output Characteristics
@ 125°C**

**Fig. 4. $R_{DS(on)}$ Normalized to 0.5 I_{D25} Value vs.
Junction Temperature**

Fig. 5. $R_{DS(on)}$ Normalized to 0.5 I_{D25} Value vs. I_D

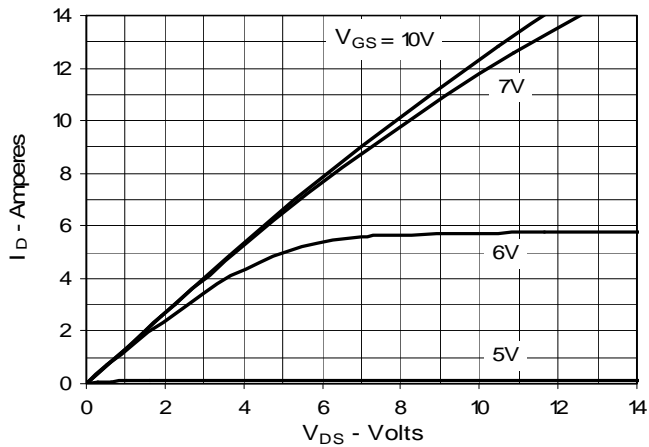
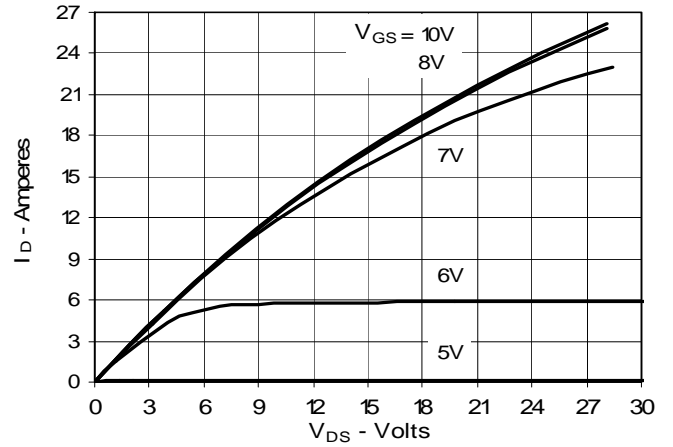
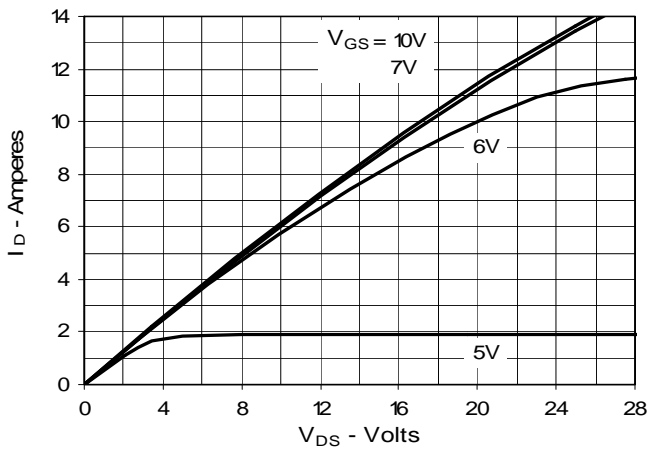
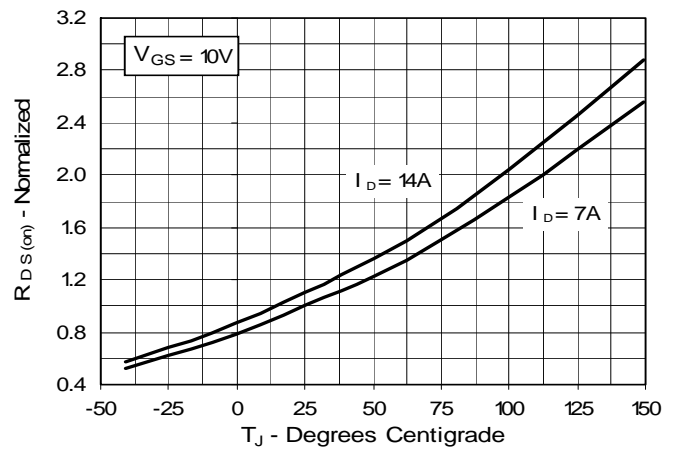
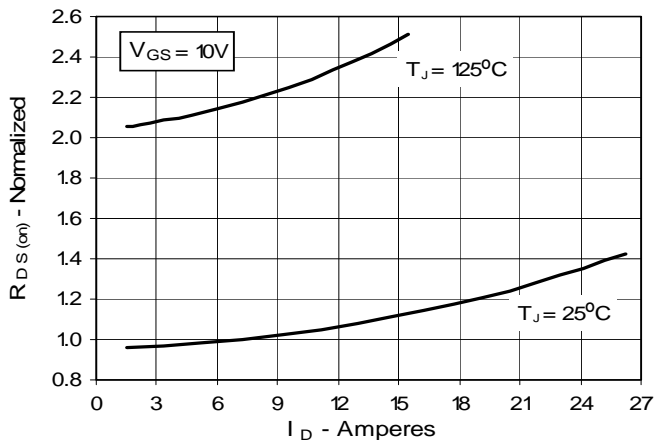
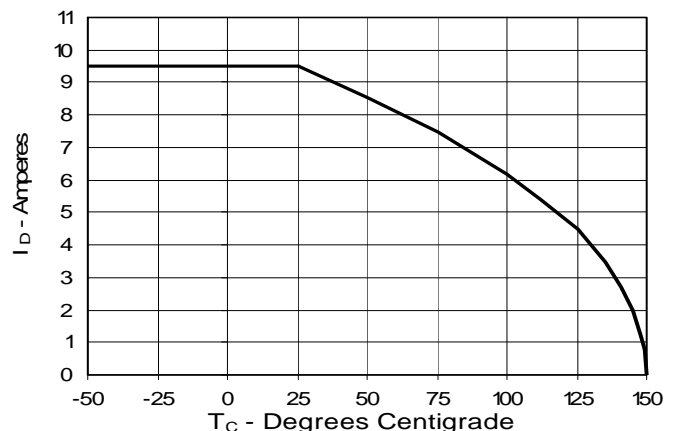
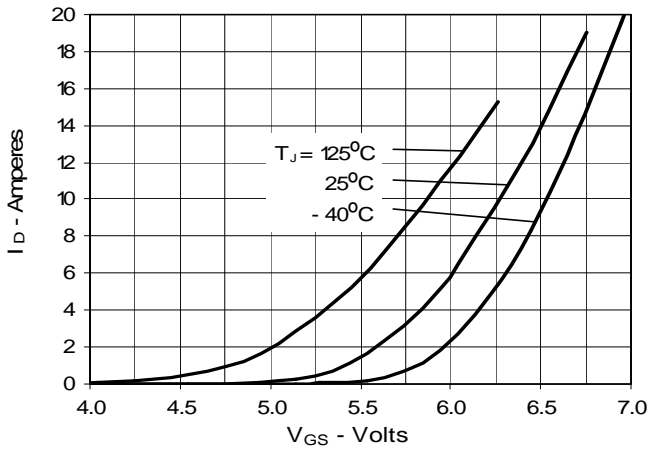
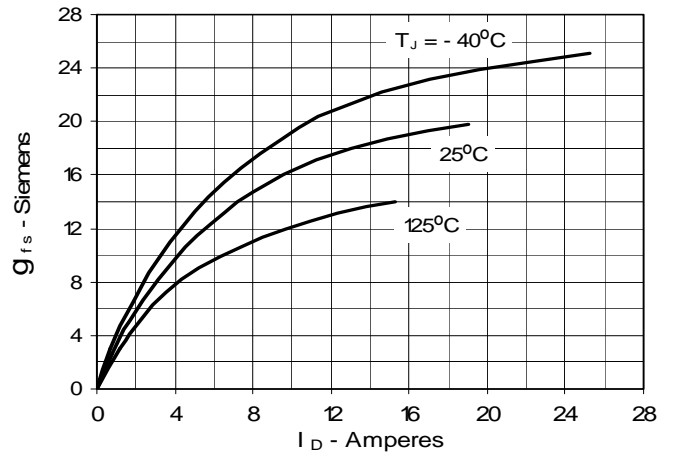
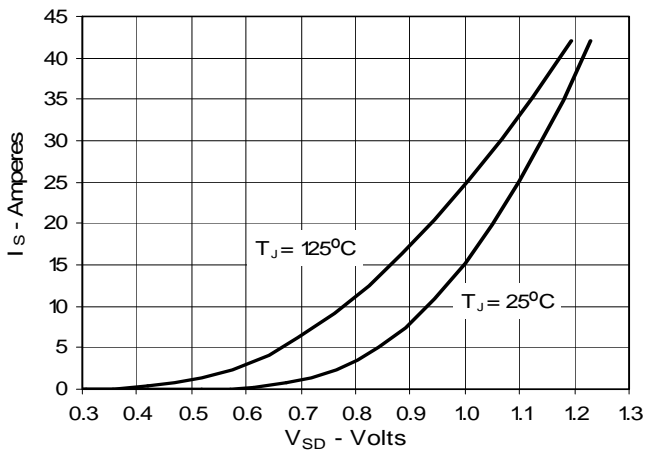
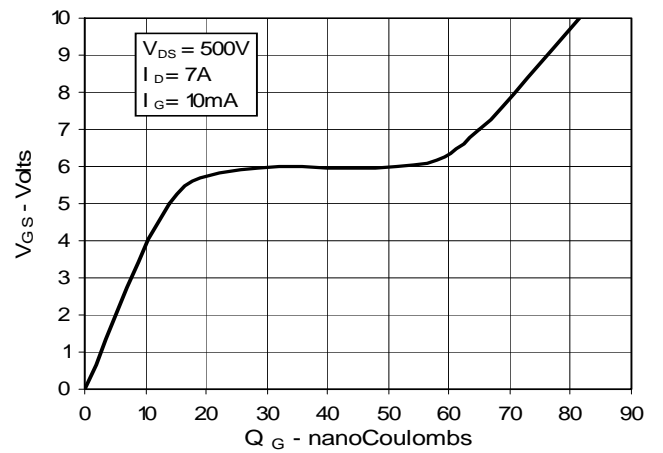
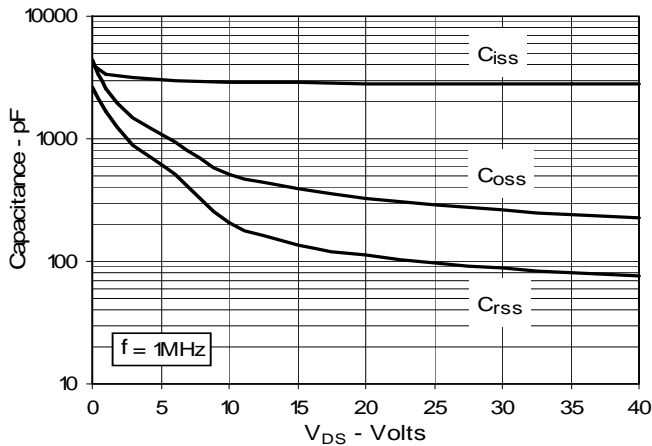
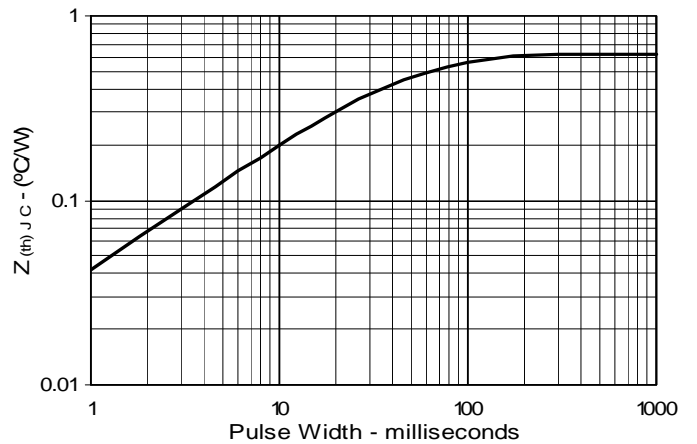
Fig. 6. Drain Current vs. Case Temperature

Fig. 7. Input Admittance

Fig. 8. Transconductance

Fig. 9. Source Current vs. Source-To-Drain Voltage

Fig. 10. Gate Charge

Fig. 11. Capacitance

Fig. 12. Maximum Transient Thermal Impedance



Disclaimer Notice - Information furnished is believed to be accurate and reliable. However, users should independently evaluate the suitability of and test each product selected for their own applications. Littelfuse products are not designed for, and may not be used in, all applications. Read complete Disclaimer Notice at www.littelfuse.com/disclaimer-electronics.