

PolarHV™ HiPerFET

Power MOSFET

ISOPLUS247™

(Electrically Isolated Back Surface)

IXFR 48N60P

$V_{DSS} = 600 \text{ V}$
 $I_{D25} = 32 \text{ A}$
 $R_{DS(on)} \leq 150 \text{ m}\Omega$
 $t_{rr} \leq 200 \text{ ns}$

N-Channel Enhancement Mode
 Avalanche Rated
 Fast Intrinsic Diode

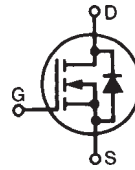

Symbol	Test Conditions	Maximum Ratings	
V_{DSS}	$T_J = 25^\circ\text{C}$ to 150°C	600	V
V_{DGR}	$T_J = 25^\circ\text{C}$ to 150°C ; $R_{GS} = 1 \text{ M}\Omega$	600	V
V_{GSS}	Continuous	± 30	V
V_{GSM}	Transient	± 40	V
I_{D25}	$T_C = 25^\circ\text{C}$	32	A
I_{DM}	$T_C = 25^\circ\text{C}$, pulse width limited by T_{JM}	110	A
I_{AR}	$T_C = 25^\circ\text{C}$	32	A
E_{AR}	$T_C = 25^\circ\text{C}$	70	mJ
E_{AS}	$T_C = 25^\circ\text{C}$	2.0	J
dv/dt	$I_S \leq I_{DM}$, $di/dt \leq 100 \text{ A}/\mu\text{s}$, $V_{DD} \leq V_{DSS}$, $T_J \leq 150^\circ\text{C}$, $R_G = 4 \Omega$	20	V/ns
P_D	$T_C = 25^\circ\text{C}$	300	W
T_J		-55 ... +150	$^\circ\text{C}$
T_{JM}		150	$^\circ\text{C}$
T_{stg}		-55 ... +150	$^\circ\text{C}$
T_L	1.6 mm (0.062 in.) from case for 10 s	300	$^\circ\text{C}$
V_{ISOL}	50/60 Hz, RMS, 1 minute	2500	V~
F_C	Mounting Force	20..120 / 4.5..26	N/lb.
Weight		5	g

ISOPLUS247 (IXFR)
 E153432

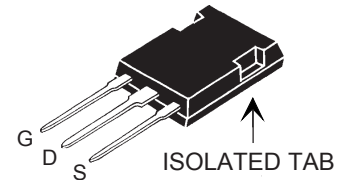

G = Gate D = Drain
 S = Source

Features

- † International standard isolated package
- † UL recognized package
- † Silicon chip on Direct-Copper-Bond substrate
 - High power dissipation
 - Isolated mounting surface
 - 2500V electrical isolation
- † Unclamped Inductive Switching (UIS) rated
 - † Low package inductance
 - easy to drive and to protect
- † Fast intrinsic diode

Advantages

- † Easy to mount
- † Space savings
- † High power density

Symbol	Test Conditions	Characteristic Values		
		Min.	Typ.	Max.
BV_{DSS}	$V_{GS} = 0 \text{ V}$, $I_D = 250 \mu\text{A}$	600		V
$V_{GS(th)}$	$V_{DS} = V_{GS}$, $I_D = 8 \text{ mA}$	3.0		5.0 V
I_{GSS}	$V_{GS} = \pm 30 \text{ V}_{DC}$, $V_{DS} = 0$			$\pm 200 \text{ nA}$
I_{DSS}	$V_{DS} = V_{DSS}$, $V_{GS} = 0 \text{ V}$			25 μA 1000 μA
$R_{DS(on)}$	$V_{GS} = 10 \text{ V}$, $I_D = I_T$			150 $\text{m}\Omega$

Symbol	Test Conditions	Characteristic Values ($T_J = 25^\circ\text{C}$, unless otherwise specified)		
		Min.	Typ.	Max.
g_{fs}	$V_{DS} = 20\text{ V}; I_D = I_T$, Notes 1, 2	35	53	S
C_{iss}	$V_{GS} = 0\text{ V}, V_{DS} = 25\text{ V}, f = 1\text{ MHz}$		8860	pF
C_{oss}			850	pF
C_{rss}			60	pF
$t_{d(on)}$	$V_{DS} = 0.5 V_{DSS}, I_D = I_T, V_{GS} = 10\text{ V}$ $R_G = 2\ \Omega$ (External)		30	ns
t_r			25	ns
$t_{d(off)}$			85	ns
t_f			22	ns
$Q_{g(on)}$	$V_{GS} = 10\text{ V}, V_{DS} = 0.5 V_{DSS}, I_D = I_T$		150	nC
Q_{gs}			50	nC
Q_{gd}			50	nC
R_{thJC}			0.42	$^\circ\text{C/W}$
R_{thCS}		0.15		$^\circ\text{C/W}$

Source-Drain Diode

Symbol	Test Conditions	Characteristic Values ($T_J = 25^\circ\text{C}$, unless otherwise specified)		
		Min.	Typ.	Max.
I_S	$V_{GS} = 0\text{ V}$			32 A
I_{SM}	Repetitive			110 A
V_{SD}	$I_F = I_S, V_{GS} = 0\text{ V}$, Note 1			1.5 V
t_{rr}	$I_F = 20\text{ A}, -di/dt = 100\text{ A}/\mu\text{s}$ $V_R = 480\text{ V}$			200 ns
Q_{RM}			0.8	μC
I_{RM}			6.0	A

Notes:

1. Pulse test, $t \leq 300\ \mu\text{s}$, duty cycle $d \leq 2\%$;
2. Test current $I_T = 24\text{ A}$.

ISOPLUS247 Outline

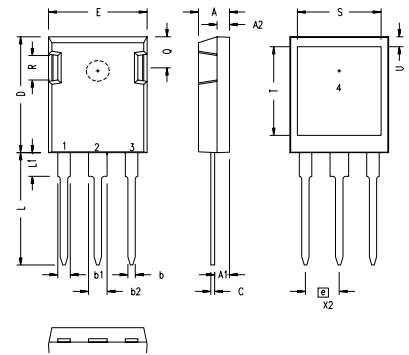

SYM	INCHES		MILLIMETERS	
	MIN	MAX	MIN	MAX
A	.190	.205	4.83	5.21
A1	.090	.100	2.29	2.54
A2	.075	.085	1.91	2.16
b	.045	.055	1.14	1.40
b1	.075	.084	1.91	2.13
b2	.115	.123	2.92	3.12
C	.024	.031	0.61	0.80
D	.819	.840	20.80	21.34
E	.620	.635	15.75	16.13
e	.215 BSC		5.45 BSC	
L	.780	.800	19.81	20.32
L1	.150	.170	3.81	4.32
Q	.220	.244	5.59	6.20
R	.170	.190	4.32	4.83
S	.520	.540	13.21	13.72
T	.620	.640	15.75	16.26
U	.065	.080	1.65	2.03

- 1 - GATE
- 2 - DRAIN (COLLECTOR)
- 3 - SOURCE (EMITTER)
- 4 - NO CONNECTION

NOTE: This drawing will meet all dimensions requirement of JEDEC outline TO-247AD except screw hole.

Fig. 1. Output Characteristics
@ 25°C

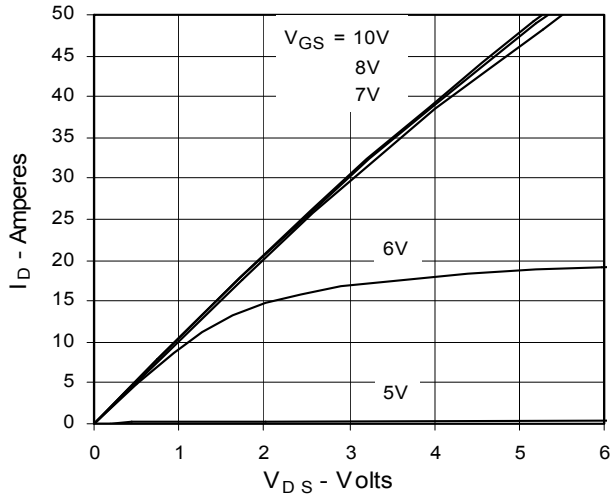

Fig. 2. Extended Output Characteristics
@ 25°C

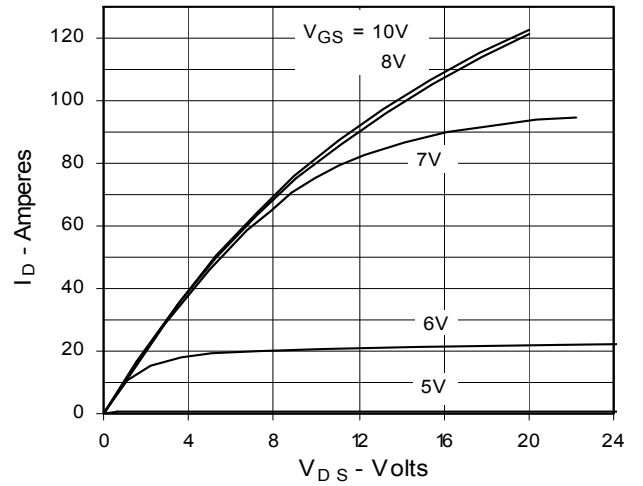

Fig. 3. Output Characteristics
@ 125°C

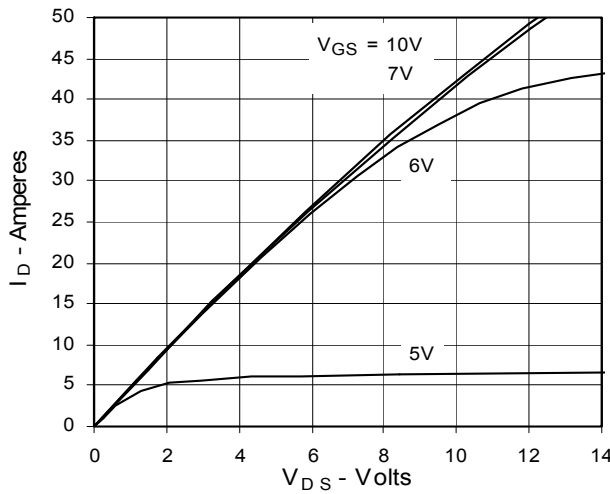

Fig. 4. $R_{DS(on)}$ Normalized to $I_D = 24A$ Value vs. Junction Temperature

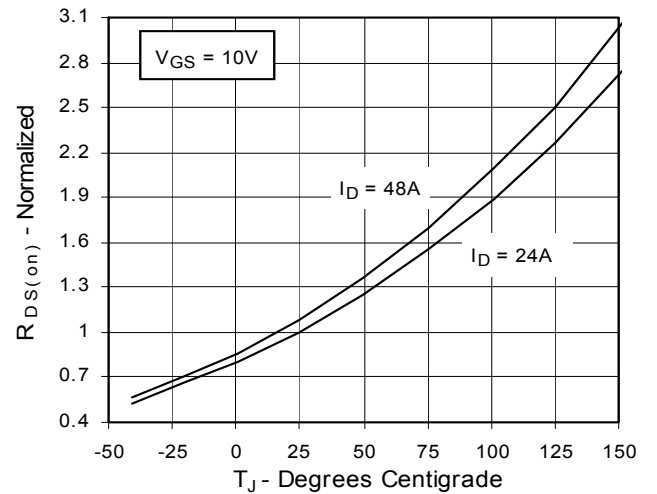

Fig. 5. $R_{DS(on)}$ Normalized to $I_D = 24A$ Value vs. Drain Current

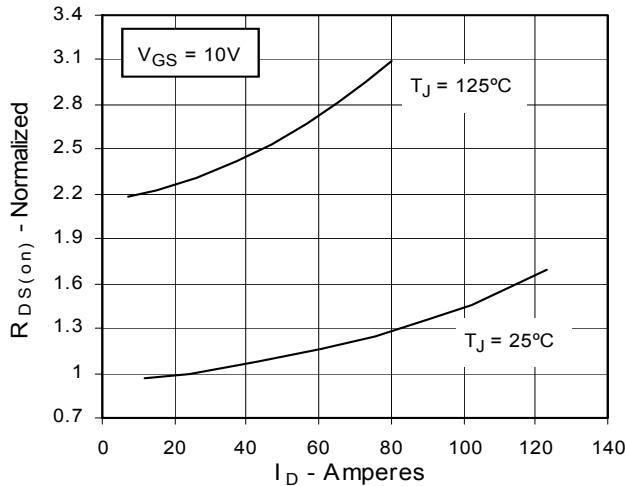

Fig. 6. Drain Current vs. Case Temperature

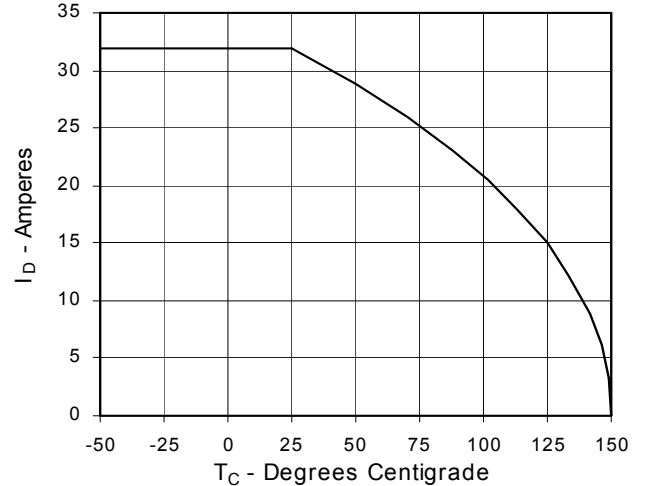

Fig. 7. Input Admittance

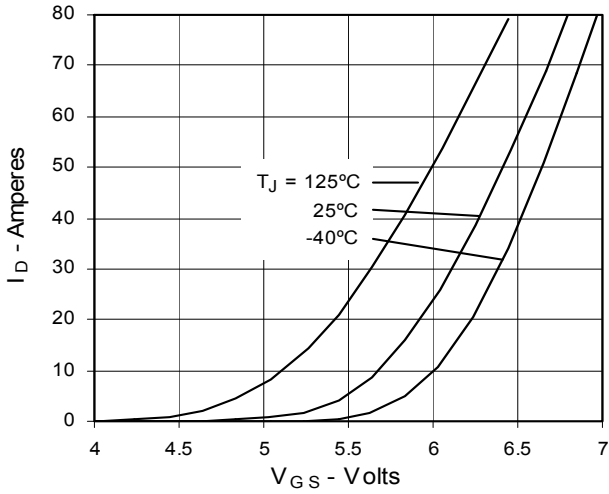

Fig. 8. Transconductance

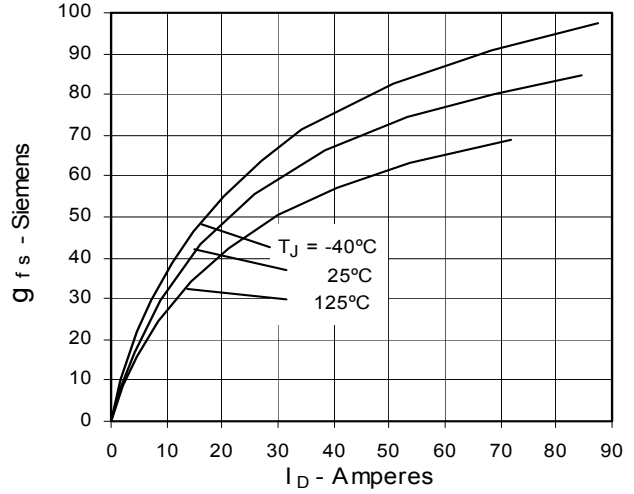

Fig. 9. Source Current vs. Source-To-Drain Voltage

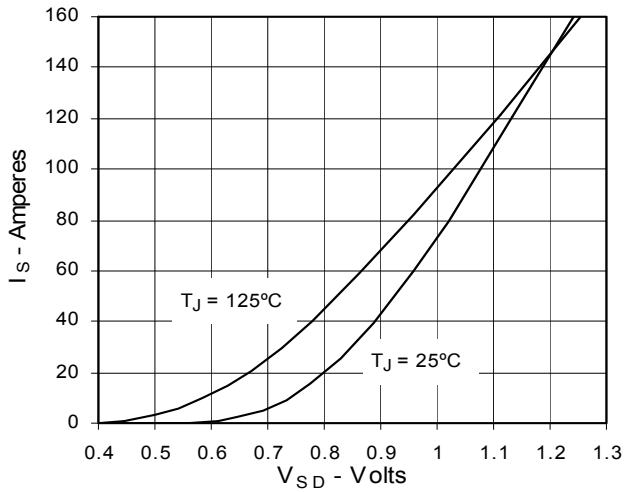

Fig. 10. Gate Charge

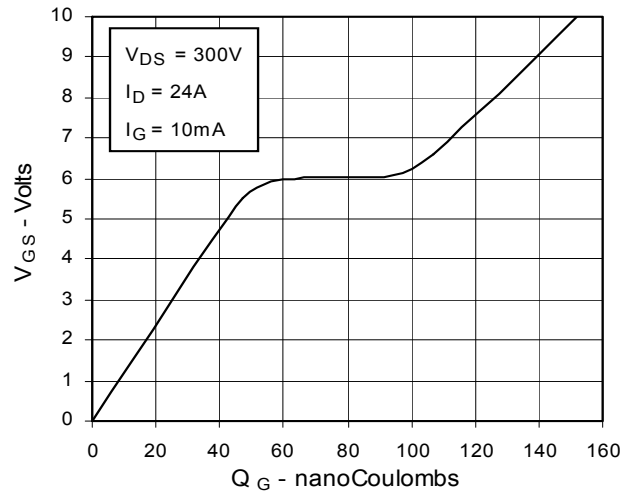

Fig. 11. Capacitance

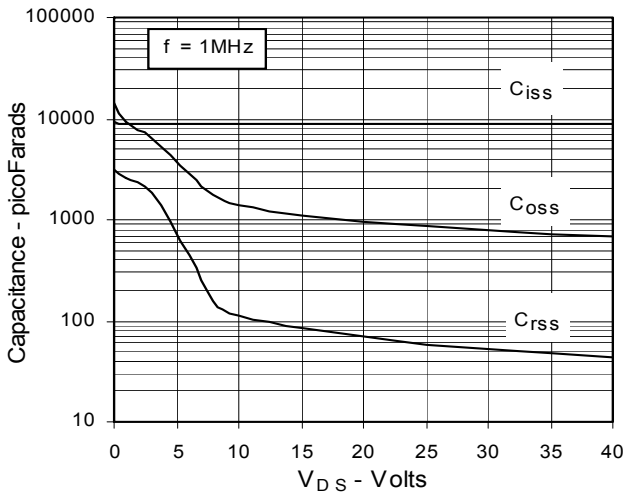
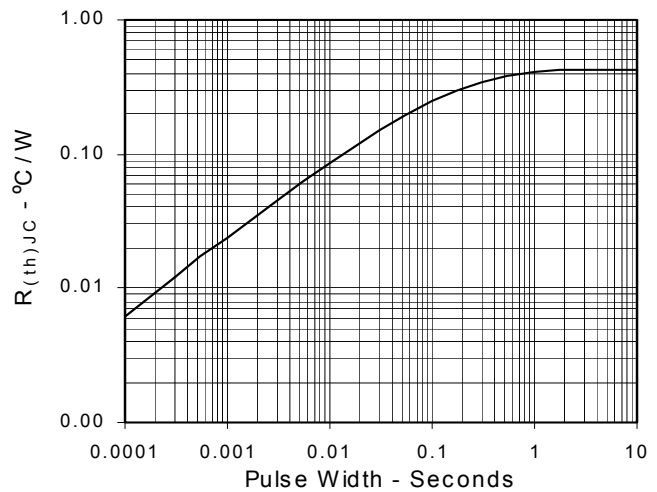

Fig. 13. Maximum Transient Thermal Resistance





Disclaimer Notice - Information furnished is believed to be accurate and reliable. However, users should independently evaluate the suitability of and test each product selected for their own applications. Littelfuse products are not designed for, and may not be used in, all applications. Read complete Disclaimer Notice at www.littelfuse.com/disclaimer-electronics.