

**LinearL2™ Power  
MOSFET w/Extended  
FBSOA**
**IXTK110N20L2  
IXTX110N20L2**
 $V_{DSS} = 200V$   
 $I_{D25} = 110A$   
 $R_{DS(on)} \leq 24m\Omega$ 

 N-Channel Enhancement Mode  
 Guaranteed FBSOA  
 Avalanche Rated

Symbol	Test Conditions	Maximum Ratings	
$V_{DSS}$	$T_J = 25^\circ C$ to $150^\circ C$	200	V
$V_{DGR}$	$T_J = 25^\circ C$ to $150^\circ C$ , $R_{GS} = 1M\Omega$	200	V
$V_{GSS}$	Continuous	$\pm 20$	V
$V_{GSM}$	Transient	$\pm 30$	V
$I_{D25}$	$T_C = 25^\circ C$	110	A
$I_{DM}$	$T_C = 25^\circ C$ , Pulse Width Limited by $T_{JM}$	275	A
$I_A$	$T_C = 25^\circ C$	55	A
$E_{AS}$	$T_C = 25^\circ C$	5	J
$P_D$	$T_C = 25^\circ C$	960	W
$T_J$		-55...+150	$^\circ C$
$T_{JM}$		150	$^\circ C$
$T_{stg}$		-55...+150	$^\circ C$
$T_L$	1.6mm (0.063 in.) from Case for 10s	300	$^\circ C$
$T_{SOLD}$	Plastic Body for 10s	260	$^\circ C$
$M_d$	Mounting Torque (IXTK)	1.13/10	Nm/lb.in.
$F_c$	Mounting Force (IXTX)	20..120 / 4.5..27	N/lb.
<b>Weight</b>	TO-264	10	g
	PLUS247	6	g

TO-264 (IXTK)

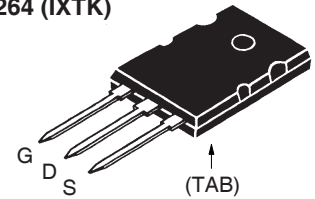

PLUS247(IXTX)

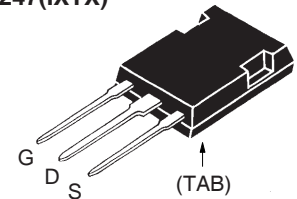
 G = Gate      D = Drain  
 S = Source    TAB = Drain

**Features**

- Designed for Linear Operation
- International Standard Packages
- Avalanche Rated
- Guaranteed FBSOA at  $75^\circ C$

**Advantages**

- Easy to Mount
- Space Savings
- High Power Density

**Applications**

- Solid State Circuit Breakers
- Soft Start Controls
- Linear Amplifiers
- Programmable Loads
- Current Regulators

Symbol	Test Conditions ( $T_J = 25^\circ C$ , Unless Otherwise Specified)	Characteristic Values		
		Min.	Typ.	Max.
$BV_{DSS}$	$V_{GS} = 0V$ , $I_D = 1mA$	200		V
$V_{GS(th)}$	$V_{DS} = V_{GS}$ , $I_D = 3mA$	2.0		V
$I_{GSS}$	$V_{GS} = \pm 20V$ , $V_{DS} = 0V$			$\pm 200$ nA
$I_{DSS}$	$V_{DS} = V_{DSS}$ , $V_{GS} = 0V$ $T_J = 125^\circ C$			50 $\mu A$ 2.5 mA
$R_{DS(on)}$	$V_{GS} = 10V$ , $I_D = 0.5 \cdot I_{D25}$ , Note 1			24 m $\Omega$

Symbol	Test Conditions ( $T_J = 25^\circ\text{C}$ , Unless Otherwise Specified)	Characteristic Values			
		Min.	Typ.	Max.	
$g_{fs}$	$V_{DS} = 10\text{V}$ , $I_D = 0.5 \cdot I_{D25}$ , Note 1	55	75	95	S
$C_{iss}$	$V_{GS} = 0\text{V}$ , $V_{DS} = 25\text{V}$ , $f = 1\text{MHz}$		23		nF
$C_{oss}$			2160		pF
$C_{rss}$			320		pF
$t_{d(on)}$	<b>Resistive Switching Times</b> $V_{GS} = 10\text{V}$ , $V_{DS} = 0.5 \cdot V_{DSS}$ , $I_D = 0.5 \cdot I_{D25}$ $R_G = 1\Omega$ (External)		40		ns
$t_r$			100		ns
$t_{d(off)}$			33		ns
$t_f$			135		ns
$Q_{g(on)}$	$V_{GS} = 10\text{V}$ , $V_{DS} = 0.5 \cdot V_{DSS}$ , $I_D = 0.5 \cdot I_{D25}$		500		nC
$Q_{gs}$			110		nC
$Q_{gd}$			182		nC
$R_{thJC}$				0.13	$^\circ\text{C/W}$
$R_{thCS}$				0.15	$^\circ\text{C/W}$

### Safe-Operating-Area Specification

Symbol	Test Conditions	Characteristic Values			
		Min.	Typ.	Max.	
SOA	$V_{DS} = 200\text{V}$ , $I_D = 2.88\text{A}$ , $T_C = 75^\circ\text{C}$ , $T_p = 5\text{s}$	575			W

### Source-Drain Diode

Symbol	Test Conditions ( $T_J = 25^\circ\text{C}$ , Unless Otherwise Specified)	Characteristic Values			
		Min.	Typ.	Max.	
$I_S$	$V_{GS} = 0\text{V}$			110	A
$I_{SM}$	Repetitive, Pulse Width Limited by $T_{JM}$			440	A
$V_{SD}$	$I_F = 55\text{A}$ , $V_{GS} = 0\text{V}$ , Note 1			1.35	V
$t_{rr}$	$I_F = 55\text{A}$ , $-di/dt = 100\text{A}/\mu\text{s}$ , $V_R = 100\text{V}$ , $V_{GS} = 0\text{V}$		420		ns
$I_{RM}$			39		A
$Q_{RM}$			8.3		$\mu\text{C}$

Note 1. Pulse test,  $t \leq 300\mu\text{s}$ ; duty cycle,  $d \leq 2\%$ .

### ADVANCE TECHNICAL INFORMATION

The product presented herein is under development. The Technical Specifications offered are derived from a subjective evaluation of the design, based upon prior knowledge and experience, and constitute a "considered reflection" of the anticipated result. IXYS reserves the right to change limits, test conditions, and dimensions without notice.

IXYS Reserves the Right to Change Limits, Test Conditions, and Dimensions.

IXYS MOSFETs and IGBTs are covered by one or more of the following U.S. patents: 4,835,592 4,931,844 5,049,961 5,237,481 6,162,665 6,404,065 B1 6,683,344 6,727,585 7,005,734 B2 7,157,338 B2  
4,850,072 5,017,508 5,063,307 5,381,025 6,259,123 B1 6,534,343 6,710,405 B2 6,759,692 7,063,975 B2  
4,881,106 5,034,796 5,187,117 5,486,715 6,306,728 B1 6,583,505 6,710,463 6,771,478 B2 7,071,537

### TO-264 (IXTK) Outline

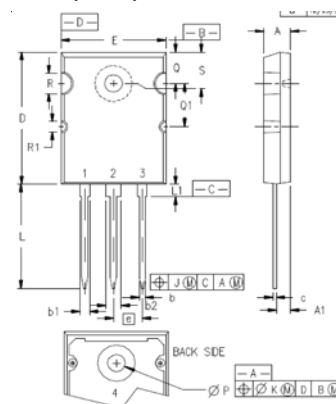

1 - GATE  
2, 4 - DRAIN (COLLECTOR)  
3 - SOURCE (EMITTER)

SYM	INCHES		MILLIMETERS	
	MIN	MAX	MIN	MAX
A	.185	.209	4.70	5.31
A1	.102	.118	2.59	3.00
b	.037	.055	0.94	1.40
b1	.087	.102	2.21	2.59
b2	.110	.126	2.79	3.20
c	.017	.029	0.43	0.74
D	1.007	1.047	25.58	26.59
E	.760	.799	19.30	20.29
e	.215 BSC		5.46 BSC	
J	.000	.010	0.00	0.25
K	.000	.010	0.00	0.25
L	.779	.842	19.79	21.39
L1	.087	.102	2.21	2.59
$\varnothing P$	.122	.138	3.10	3.51
Q	.240	.256	6.10	6.50
Q1	.330	.346	8.38	8.79
$\varnothing R$	.155	.187	3.94	4.75
$\varnothing R1$	.085	.093	2.16	2.36
S	.243	.253	6.17	6.43

### PLUS 247™ (IXTX) Outline

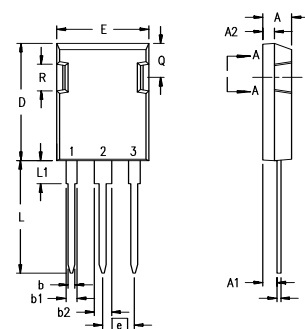

Terminals: 1 - Gate  
2 - Drain (Collector)  
3 - Source (Emitter)  
4 - Drain (Collector)

Dim.	Millimeter		Inches	
	Min.	Max.	Min.	Max.
A	4.83	5.21	.190	.205
A <sub>1</sub>	2.29	2.54	.090	.100
A <sub>2</sub>	1.91	2.16	.075	.085
b	1.14	1.40	.045	.055
b <sub>1</sub>	1.91	2.13	.075	.084
b <sub>2</sub>	2.92	3.12	.115	.123
C	0.61	0.80	.024	.031
D	20.80	21.34	.819	.840
E	15.75	16.13	.620	.635
e	5.45 BSC		.215 BSC	
L	19.81	20.32	.780	.800
L1	3.81	4.32	.150	.170
Q	5.59	6.20	.220	0.244
R	4.32	4.83	.170	.190

**Fig. 1. Output Characteristics**  
@  $T_J = 25^\circ\text{C}$

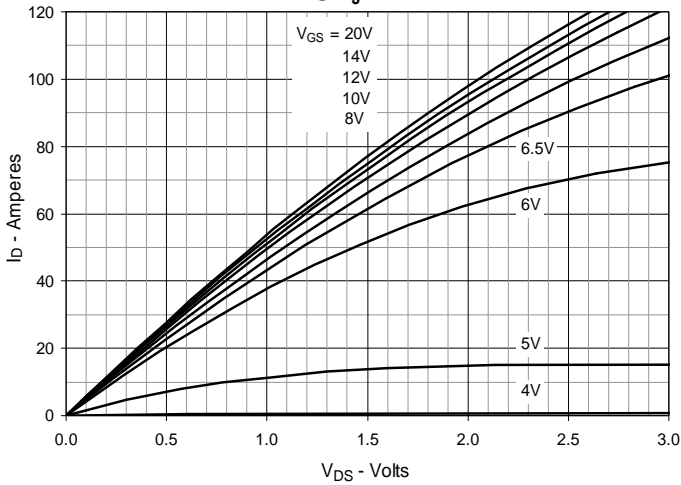

**Fig. 2. Extended Output Characteristics**  
@  $T_J = 25^\circ\text{C}$

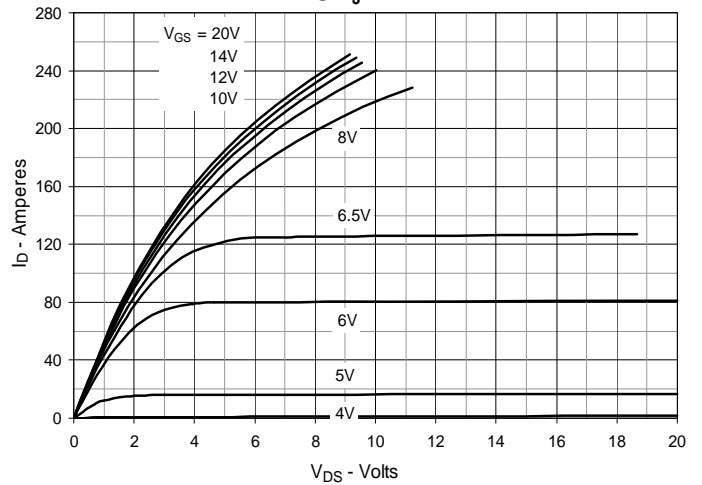

**Fig. 3. Output Characteristics**  
@  $T_J = 125^\circ\text{C}$

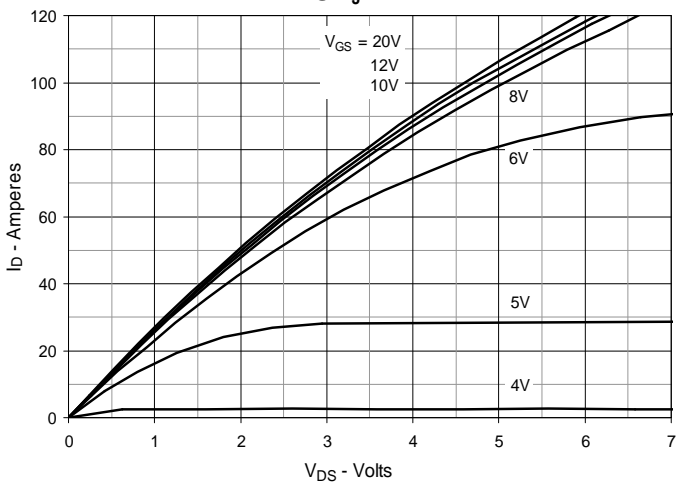

**Fig. 4.  $R_{DS(on)}$  Normalized to  $I_D = 55\text{A}$  Value vs. Junction Temperature**

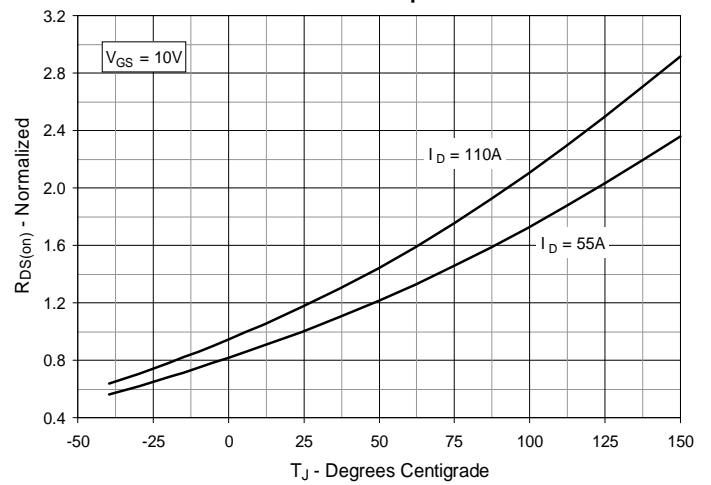

**Fig. 5.  $R_{DS(on)}$  Normalized to  $I_D = 55\text{A}$  Value vs. Drain Current**

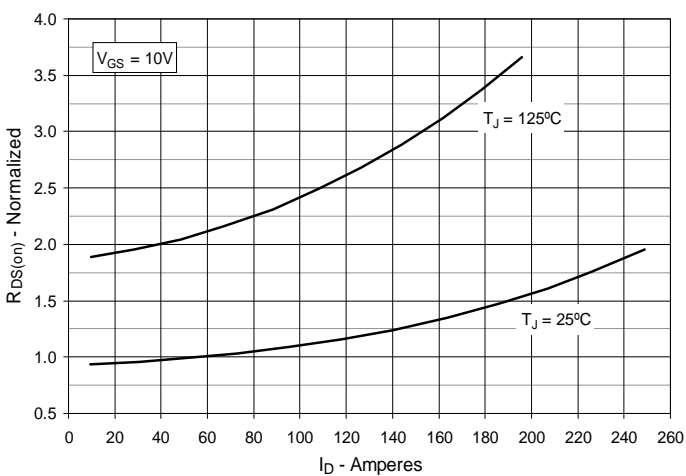

**Fig. 6. Maximum Drain Current vs. Case Temperature**

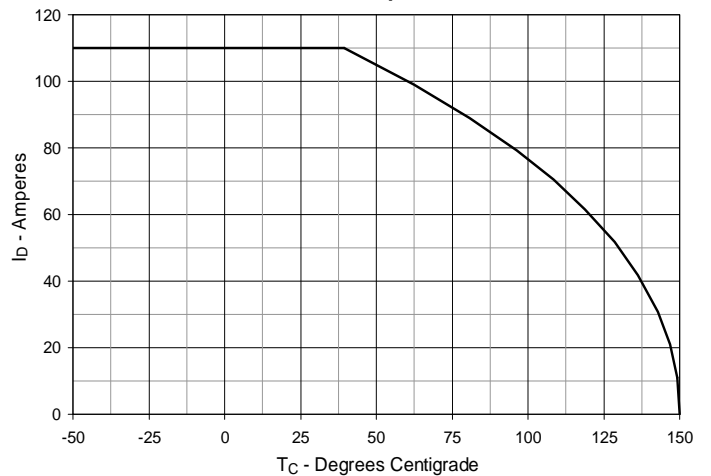

**Fig. 7. Input Admittance**

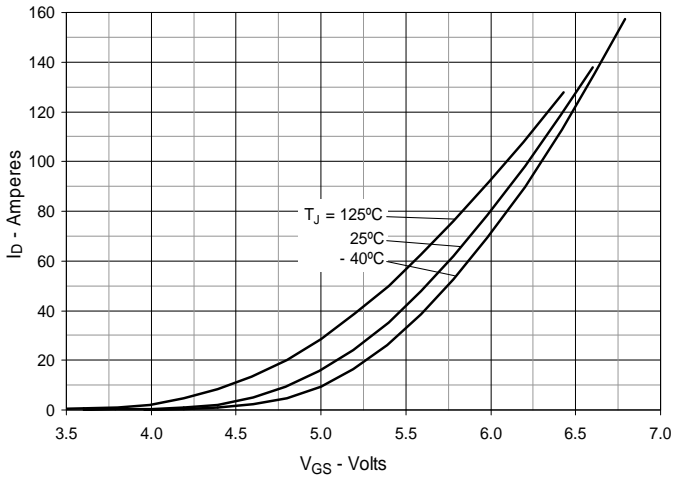

**Fig. 8. Transconductance**

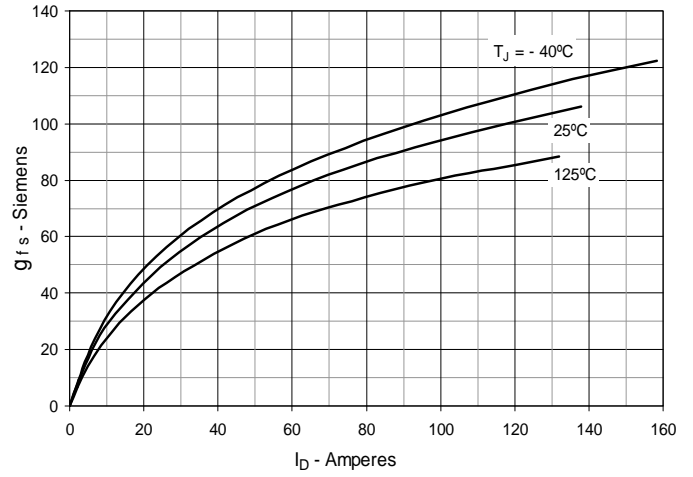

**Fig. 9. Forward Voltage Drop of Intrinsic Diode**

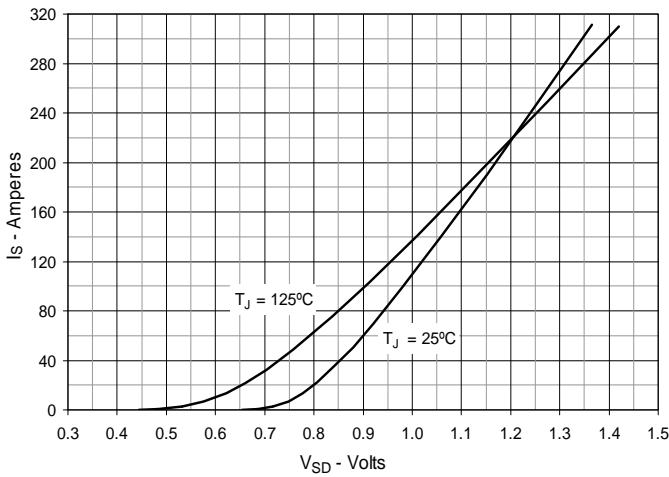

**Fig. 10. Gate Charge**

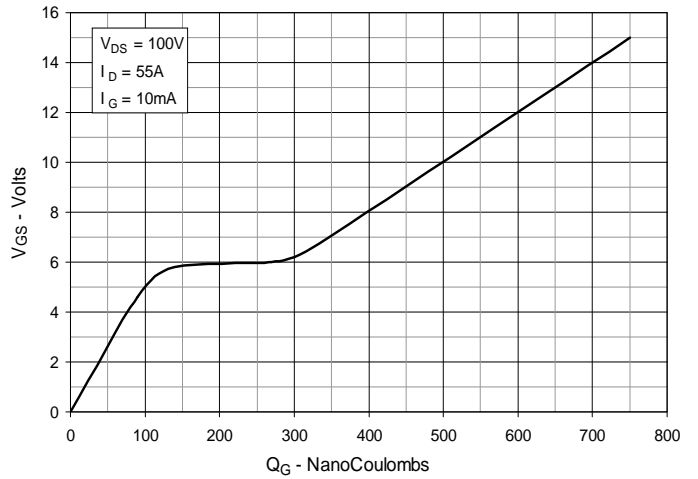

**Fig. 11. Capacitance**

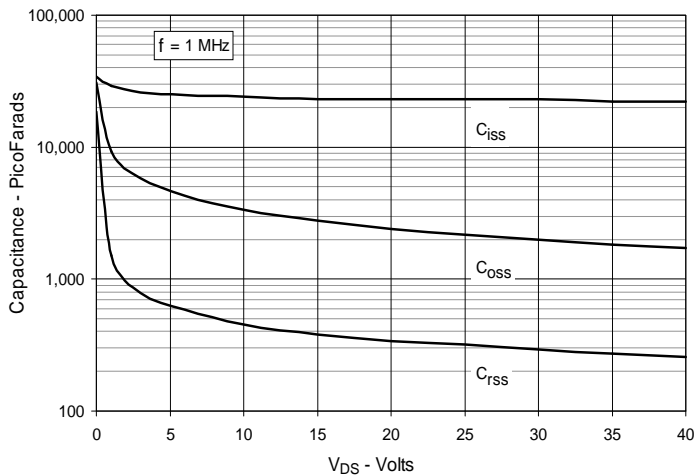

**Fig. 12. Maximum Transient Thermal Impedance**

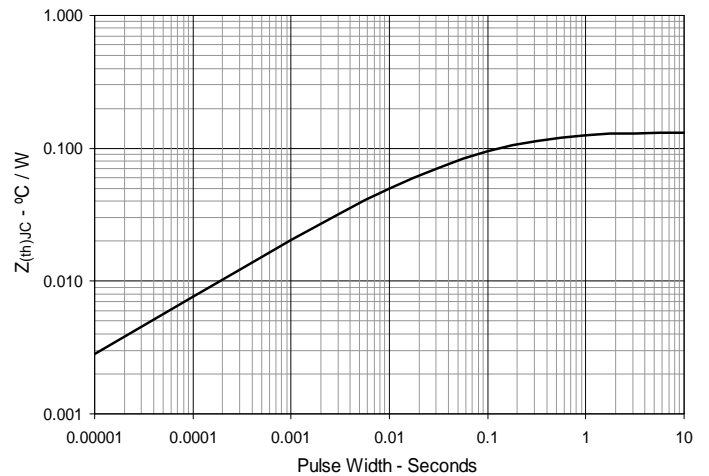

**Fig. 13. Forward-Bias Safe Operating Area**  
**@  $T_C = 25^\circ\text{C}$**

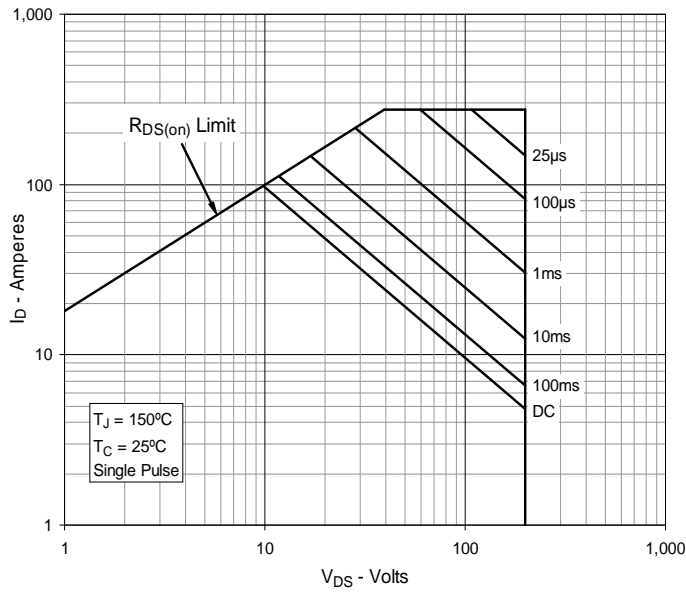

**Fig. 14. Forward-Bias Safe Operating Area**  
**@  $T_C = 75^\circ\text{C}$**

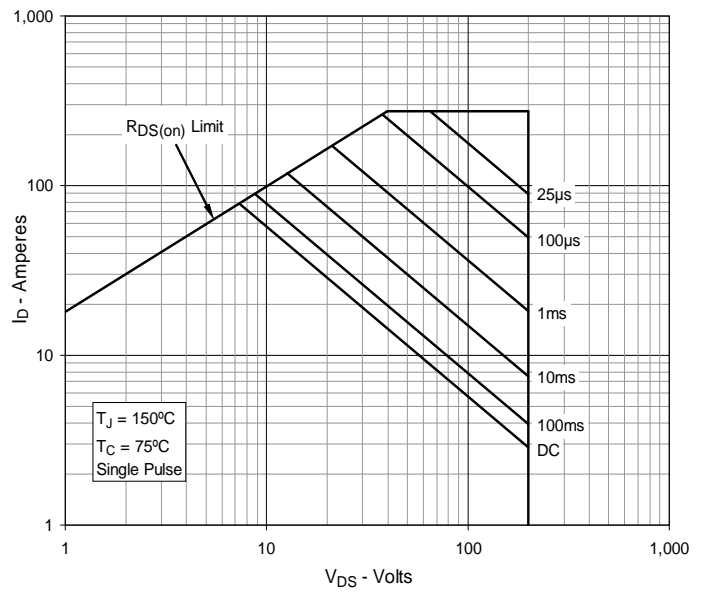



---

Disclaimer Notice - Information furnished is believed to be accurate and reliable. However, users should independently evaluate the suitability of and test each product selected for their own applications. Littelfuse products are not designed for, and may not be used in, all applications. Read complete Disclaimer Notice at [www.littelfuse.com/disclaimer-electronics](http://www.littelfuse.com/disclaimer-electronics).