

**Linear L2™
Power MOSFET
w/ Extended FBSOA**

**IXTA30N25L2
IXTP30N25L2
IXTH30N25L2**

**V_{DSS} = 250V
I_{D25} = 30A
R_{DS(on)} ≤ 140mΩ**

N-Channel Enhancement Mode
Avalanche Rated

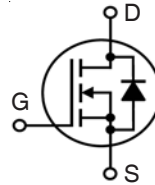

Symbol	Test Conditions	Maximum Ratings	
V _{DSS}	T _J = 25°C to 150°C	250	V
V _{DGR}	T _J = 25°C to 150°C, R _{GS} = 1MΩ	250	V
V _{GSS}	Continuous	±20	V
V _{GSM}	Transient	±30	V
I _{D25}	T _C = 25°C	30	A
I _{DM}	T _C = 25°C, Pulse Width Limited by T _{JM}	65	A
I _A	T _C = 25°C	15	A
E _{AS}	T _C = 25°C	2	J
P _D	T _C = 25°C	355	W
T _J		-55 ... +150	°C
T _{JM}		150	°C
T _{stg}		-55 ... +150	°C
T _L	Maximum Lead Temperature for Soldering	300	°C
T _{SOLD}	Plastic Body for 10s	260	°C
F _C	Mounting Force (TO-263)	10..65 / 2.2..14.6	N/lb
M _d	Mounting Torque (TO-220 & TO-247)	1.13 / 10	Nm/lb.in
Weight	TO-263	2.5	g
	TO-220	3.0	g
	TO-247	6.0	g

TO-263
(IXTA)

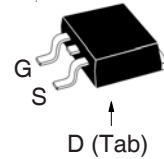

TO-220
(IXTP)

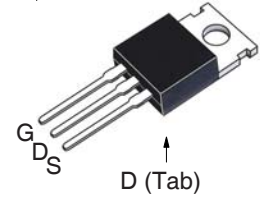

TO-247
(IXTH)

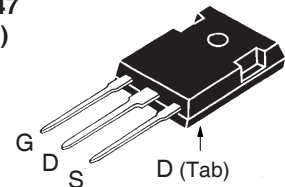

G = Gate D = Drain
S = Source Tab = Drain

Features

- Designed for Linear Operation
- International Standard Packages
- Avalanche Rated
- Molding Epoxies Meet UL 94 V-0 Flammability Classification
- Guaranteed FBSOA at 75°C

Advantages

- Easy to Mount
- Space Savings
- High Power Density

Applications

- Solid State Circuit Breakers
- Soft Start Controls
- Linear Amplifiers
- Programmable Loads
- Current Regulators

Symbol	Test Conditions (T _J = 25°C, Unless Otherwise Specified)	Characteristic Values		
		Min.	Typ.	Max.
BV _{DSS}	V _{GS} = 0V, I _D = 250μA	250		V
V _{GS(th)}	V _{DS} = V _{GS} , I _D = 250μA	2.5		4.5 V
I _{GSS}	V _{GS} = ± 20V, V _{DS} = 0V			±100 nA
I _{DSS}	V _{DS} = V _{DSS} , V _{GS} = 0V T _J = 125°C			5 μA 50 μA
R _{DS(on)}	V _{GS} = 10V, I _D = 0.5 • I _{D25} , Note 1			140 mΩ

Symbol	Test Conditions ($T_J = 25^\circ\text{C}$, Unless Otherwise Specified)	Characteristic Values		
		Min.	Typ.	Max.
g_{fs}	$V_{DS} = 10\text{V}, I_D = 0.5 \cdot I_{D25}$, Note 1	7	11	15 S
C_{iss}	$V_{GS} = 0\text{V}, V_{DS} = 25\text{V}, f = 1\text{MHz}$		3200	pF
C_{oss}			430	pF
C_{rss}			130	pF
$t_{d(on)}$	Resistive Switching Times $V_{GS} = 10\text{V}, 0.5 \cdot V_{DSS}, I_D = 0.5 \cdot I_{D25}$ $R_G = 3\Omega$ (External)		22	ns
t_r			78	ns
$t_{d(off)}$			65	ns
t_f			23	ns
$Q_{g(on)}$	$V_{GS} = 10\text{V}, V_{DS} = 0.5 \cdot V_{DSS}, I_D = 0.5 \cdot I_{D25}$		130	nC
Q_{gs}			22	nC
Q_{gd}			77	nC
R_{thJC}				0.35 $^\circ\text{C/W}$
R_{thCS}	(TO-220)		0.50	$^\circ\text{C/W}$
	(TO-247)		0.21	$^\circ\text{C/W}$

Safe Operating Area Specification

Symbol	Test Conditions ($T_J = 25^\circ\text{C}$, Unless Otherwise Specified)	Characteristic Values		
		Min.	Typ.	Max.
SOA	$V_{DS} = 200\text{V}, I_D = 1.07\text{A}, T_C = 75^\circ\text{C}, t_p = 2\text{s}$	214		W

Source-Drain Diode

Symbol	Test Conditions ($T_J = 25^\circ\text{C}$, Unless Otherwise Specified)	Characteristic Values		
		Min.	Typ.	Max.
I_S	$V_{GS} = 0\text{V}$, Note 1			30 A
I_{SM}	Repetitive, Pulse Width Limited by T_{JM}			120 A
V_{SD}	$I_F = I_S, V_{GS} = 0\text{V}$, Note 1			1.4 V
t_{rr}	$I_F = 15\text{A}, -di/dt = 100\text{A}/\mu\text{s}$ $V_R = 100\text{V}, V_{GS} = 0\text{V}$		315	ns
Q_{RM}			3.1	μC
I_{RM}			19.5	A

Note 1: Pulse test, $t \leq 300\mu\text{s}$, duty cycle, $d \leq 2\%$.

IXYS Reserves the Right to Change Limits, Test Conditions, and Dimensions.

IXYS MOSFETs and IGBTs are covered by one or more of the following U.S. patents:

4,835,592	4,931,844	5,049,961	5,237,481	6,162,665	6,404,065 B1	6,683,344	6,727,585	7,005,734 B2	7,157,338B2
4,860,072	5,017,508	5,063,307	5,381,025	6,259,123 B1	6,534,343	6,710,405 B2	6,759,692	7,063,975 B2	
4,881,106	5,034,796	5,187,117	5,486,715	6,306,728 B1	6,583,505	6,710,463	6,771,478 B2	7,071,537	

Fig. 1. Output Characteristics @ $T_J = 25^\circ\text{C}$

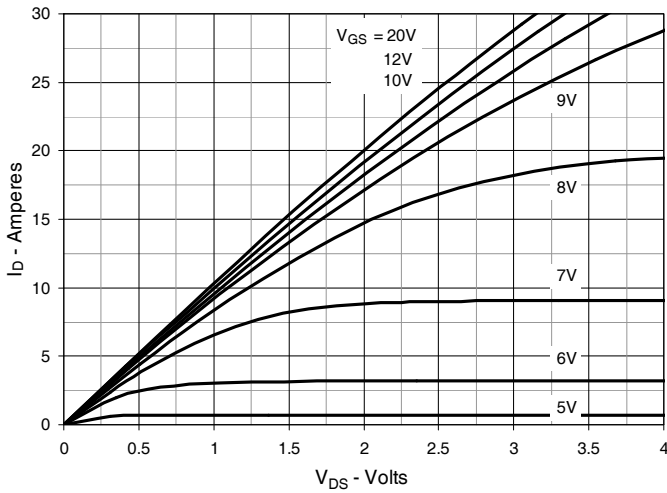

Fig. 2. Extended Output Characteristics @ $T_J = 25^\circ\text{C}$

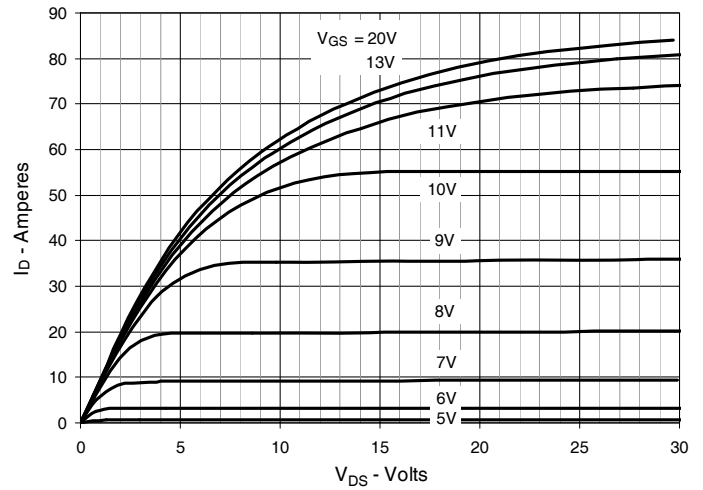

Fig. 3. Output Characteristics @ $T_J = 125^\circ\text{C}$

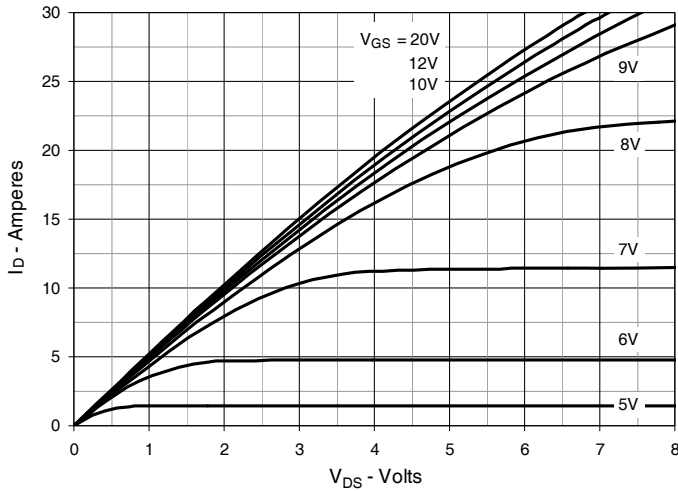

Fig. 4. $R_{DS(on)}$ Normalized to $I_D = 15\text{A}$ Value vs. Junction Temperature

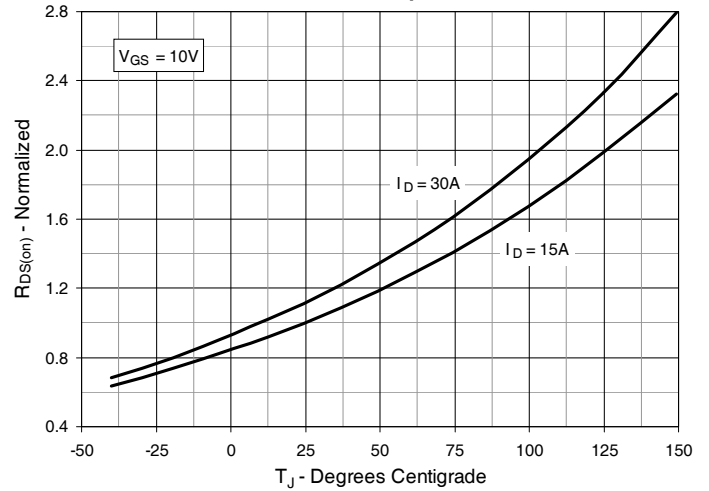

Fig. 5. $R_{DS(on)}$ Normalized to $I_D = 15\text{A}$ Value vs. Drain Current

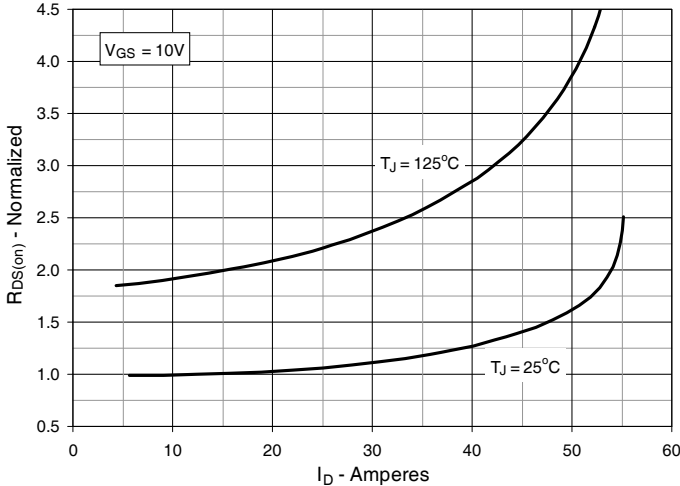

Fig. 6. Maximum Drain Current vs. Case Temperature

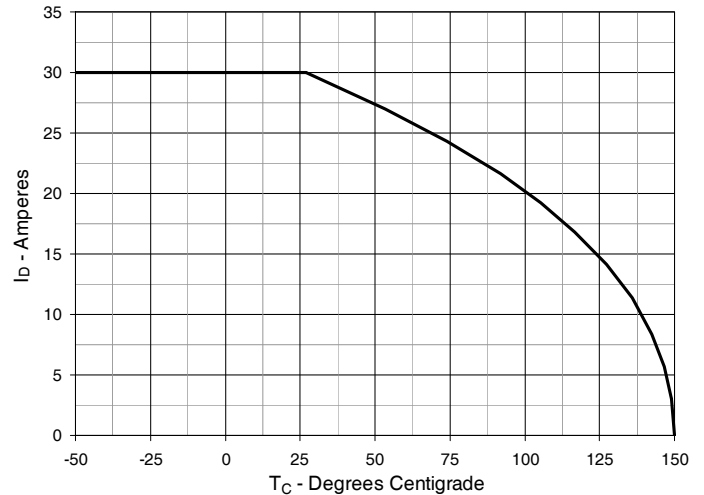

Fig. 7. Input Admittance

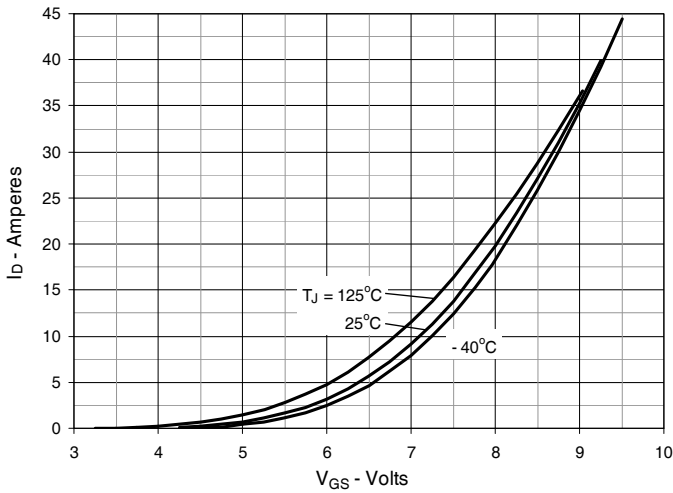

Fig. 8. Transconductance

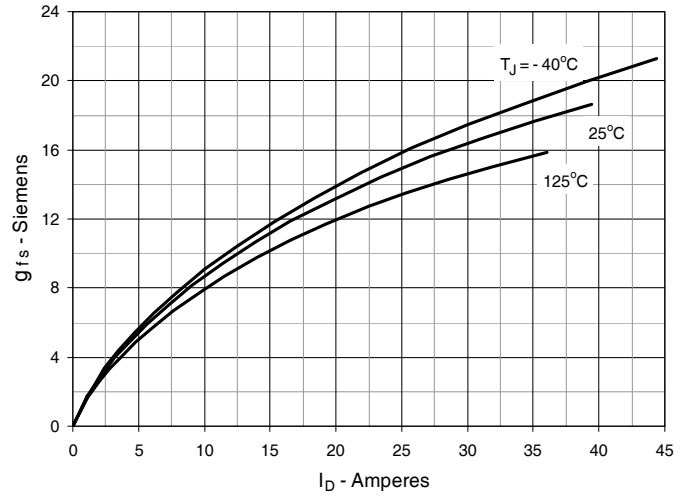

Fig. 9. Forward Voltage Drop of Intrinsic Diode

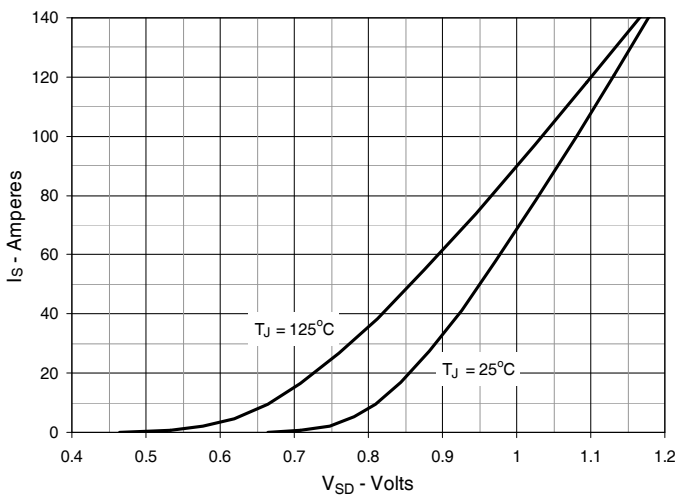

Fig. 10. Gate Charge

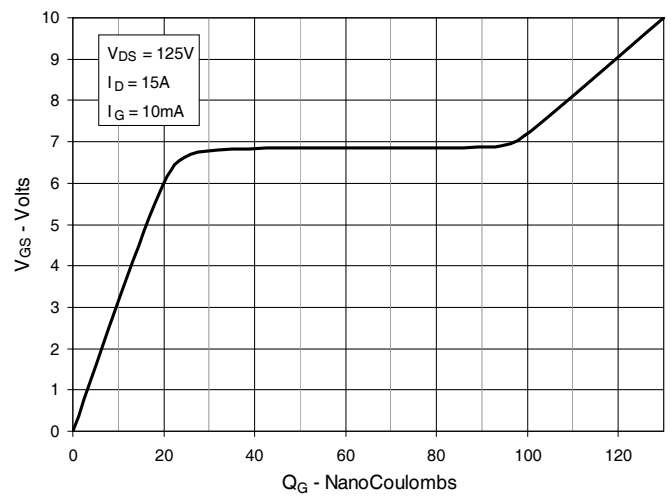

Fig. 11. Capacitance

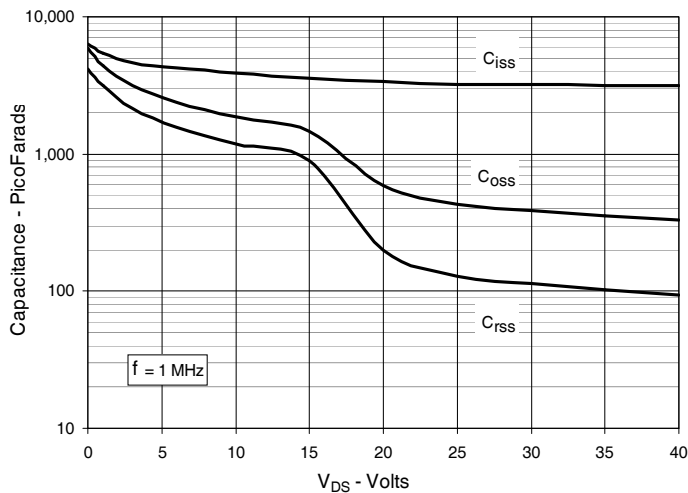

Fig. 12. Maximum Transient Thermal Impedance

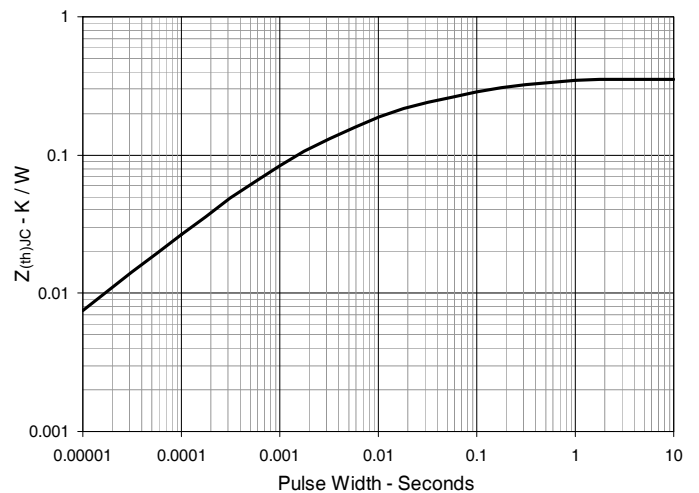

Fig. 13. Forward-Bias Safe Operating Area
@ $T_C = 25^\circ\text{C}$

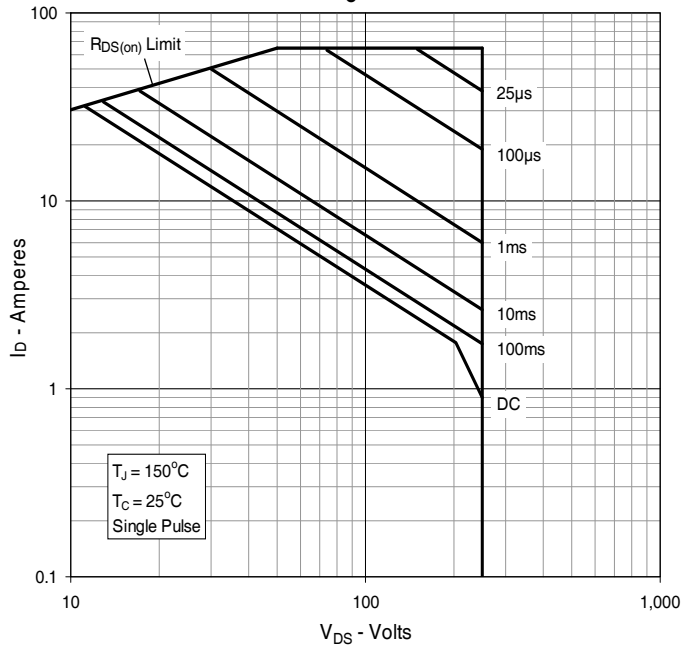
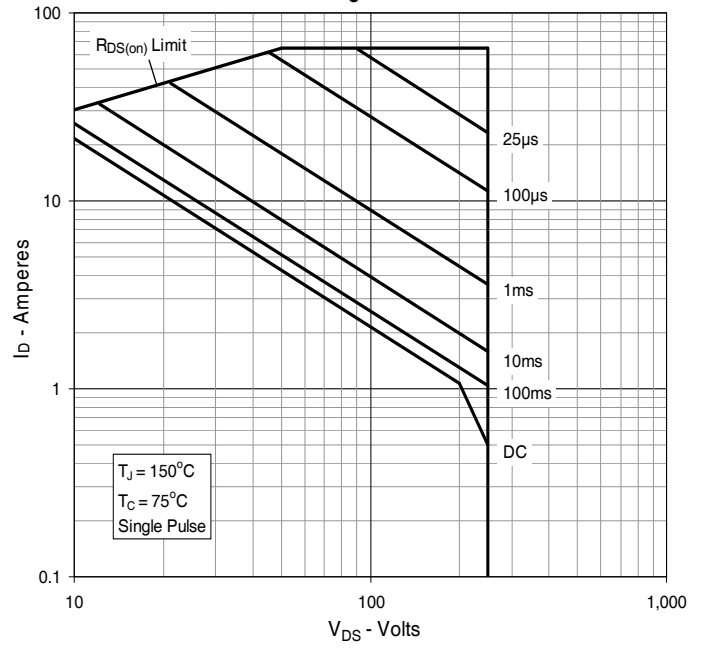
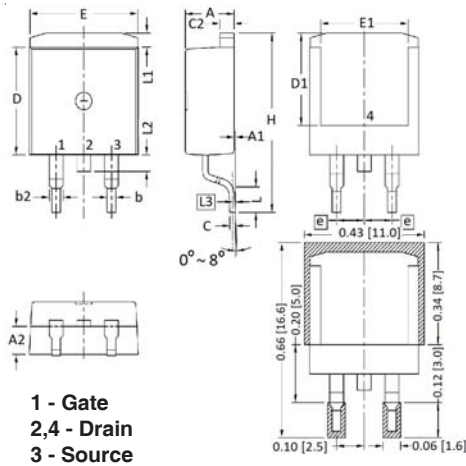

Fig. 14. Forward-Bias Safe Operating Area
@ $T_C = 75^\circ\text{C}$



TO-263 Outline



**1 - Gate
2,4 - Drain
3 - Source**

SYM	INCHES		MILLIMETER	
	MIN	MAX	MIN	MAX
A	.170	.185	4.30	4.70
A1	.000	.008	0.00	0.20
A2	.091	.098	2.30	2.50
b	.028	.035	0.70	0.90
b2	.046	.060	1.18	1.52
C	.018	.024	0.45	0.60
C2	.049	.060	1.25	1.52
D	.340	.370	8.63	9.40
D1	.300	.327	7.62	8.30
E	.380	.410	9.65	10.41
E1	.270	.330	6.86	8.38
e	.100 BSC		2.54 BSC	
H	.580	.620	14.73	15.75
L	.075	.105	1.91	2.67
L1	.039	.060	1.00	1.52
L2	—	.070	—	1.77
L3	.010 BSC		0.254 BSC	

TO-220 Outline

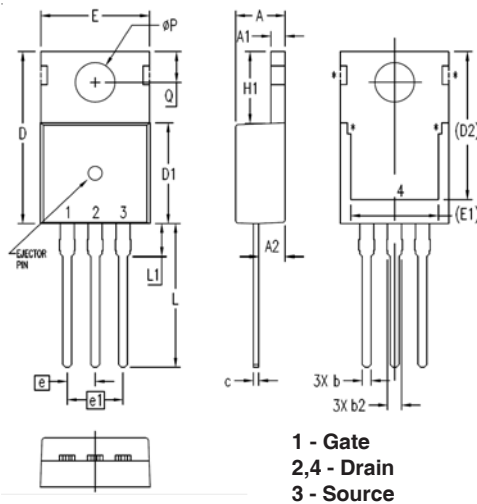

**1 - Gate
2,4 - Drain
3 - Source**

SYM	INCHES		MILLIMETERS	
	MIN	MAX	MIN	MAX
A	.169	.185	4.30	4.70
A1	.047	.055	1.20	1.40
A2	.079	.106	2.00	2.70
b	.024	.039	0.60	1.00
b2	.045	.057	1.15	1.45
c	.014	.026	0.35	0.65
D	.587	.626	14.90	15.90
D1	.335	.370	8.50	9.40
(D2)	.500	.531	12.70	13.50
E	.382	.406	9.70	10.30
(E1)	.283	.323	7.20	8.20
e	.100 BSC		2.54 BSC	
e1	.200 BSC		5.08 BSC	
H1	.244	.268	6.20	6.80
L	.492	.547	12.50	13.90
L1	.110	.154	2.80	3.90
ØP	.134	.150	3.40	3.80
Q	.106	.126	2.70	3.20

TO-247 Outline

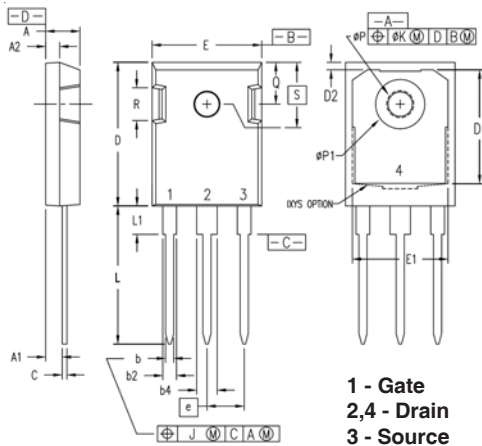

**1 - Gate
2,4 - Drain
3 - Source**

SYM	INCHES		MILLIMETERS	
	MIN	MAX	MIN	MAX
A	.190	.205	4.83	5.21
A1	.090	.100	2.29	2.54
A2	.075	.085	1.91	2.16
b	.045	.055	1.14	1.40
b2	.075	.087	1.91	2.20
b4	.115	.126	2.92	3.20
C	.024	.031	0.61	0.80
D	.819	.840	20.80	21.34
D1	.650	.690	16.51	17.53
D2	.035	.050	0.89	1.27
E	.620	.635	15.75	16.13
E1	.545	.565	13.84	14.35
e	.215 BSC		5.45 BSC	
J	—	.010	—	0.25
K	—	.025	—	0.64
L	.780	.810	19.81	20.57
L1	.150	.170	3.81	4.32
ØP	.140	.144	3.55	3.65
ØP1	.275	.290	6.99	7.37
Q	.220	.244	5.59	6.20
R	.170	.190	4.32	4.83
S	.242 BSC		6.15 BSC	



Disclaimer Notice - Information furnished is believed to be accurate and reliable. However, users should independently evaluate the suitability of and test each product selected for their own applications. Littelfuse products are not designed for, and may not be used in, all applications. Read complete Disclaimer Notice at www.littelfuse.com/disclaimer-electronics.
