

# LinearL2™ Power MOSFET w/extended FBSOA

## IXTH75N10L2 IXTT75N10L2

$$V_{DSS} = 100V$$

$$I_{D25} = 75A$$

$$R_{DS(on)} \leq 21m\Omega$$

N-Channel Enhancement Mode  
Guaranteed FBSOA  
Avalanche Rated

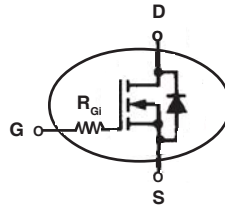

| Symbol     | Test Conditions   | Maximum Ratings |            |
|------------|---|-----------------|------------|
| $V_{DSS}$  | $T_J = 25^\circ C$ to $150^\circ C$                       | 100             | V          |
| $V_{DGR}$  | $T_J = 25^\circ C$ to $150^\circ C$ , $R_{GS} = 1M\Omega$ | 100             | V          |
| $V_{GSS}$  | Continuous  | $\pm 20$        | V          |
| $V_{GSM}$  | Transient   | $\pm 30$        | V          |
| $I_{D25}$  | $T_C = 25^\circ C$  | 75              | A          |
| $I_{DM}$   | $T_C = 25^\circ C$ , Pulse Width Limited by $T_{JM}$      | 225             | A          |
| $I_A$      | $T_C = 25^\circ C$  | 75              | A          |
| $E_{AS}$   |   | 2.5             | J          |
| $P_D$      | $T_C = 25^\circ C$  | 400             | W          |
| $T_J$      |   | -55 to +150     | $^\circ C$ |
| $T_{JM}$   |   | +150            | $^\circ C$ |
| $T_{stg}$  |   | -55 to +150     | $^\circ C$ |
| $T_L$      | 1.6mm (0.063in) from Case for 10s                         | 300             | $^\circ C$ |
| $T_{SOLD}$ | Plastic Body for 10s                                      | 260             | $^\circ C$ |
| $M_d$      | Mounting Torque (TO-247)                                  | 1.13/10         | Nm/lb.in.  |
| Weight     | TO-247  | 6.0             | g          |
|            | TO-268  | 4.0             | g          |

TO-247 (IXTH)

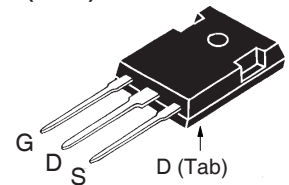

TO-268 (IXTT)

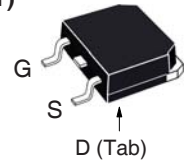

G = Gate      D = Drain  
S = Source    Tab = Drain

### Features

- Designed for Linear Operation
- International Standard Packages
- Avalanche Rated
- Integrated Gate Resistor for Easy Paralleling
- Guaranteed FBSOA at  $75^\circ C$

### Advantages

- Easy to Mount
- Space Savings
- High Power Density

### Applications

- Solid State Circuit Breakers
- Soft Start Controls
- Linear Amplifiers
- Programmable Loads
- Current Regulators

| Symbol       | Test Conditions<br>( $T_J = 25^\circ C$ , Unless Otherwise Specified) | Characteristic Values |      |                         |
|--------------|---|-----------------------|------|-------------------------|
|              |   | Min.                  | Typ. | Max.                    |
| $BV_{DSS}$   | $V_{GS} = 0V$ , $I_D = 250\mu A$                                      | 100                   |      | V                       |
| $V_{GS(th)}$ | $V_{DS} = V_{GS}$ , $I_D = 250\mu A$                                  | 2.5                   |      | V                       |
| $I_{GSS}$    | $V_{GS} = \pm 20V$ , $V_{DS} = 0V$                                    |                       |      | $\pm 100$ nA            |
| $I_{DSS}$    | $V_{DS} = V_{DSS}$ , $V_{GS} = 0V$<br>$T_J = 125^\circ C$             |                       |      | 5 $\mu A$<br>50 $\mu A$ |
| $R_{DS(on)}$ | $V_{GS} = 10V$ , $I_D = 0.5 \cdot I_{D25}$ , Note 1                   |                       |      | 21 m $\Omega$           |

| Symbol       | Test Conditions<br>( $T_J = 25^\circ\text{C}$ , Unless Otherwise Specified)  | Characteristic Values |      |      |                    |
|--------------|--|-----------------------|------|------|--------------------|
|              |  | Min.                  | Typ. | Max. |                    |
| $g_{fs}$     | $V_{DS} = 10\text{V}, I_D = 0.5 \cdot I_{D25}$ , Note 1  | 35                    | 44   | 53   | S                  |
| $C_{iss}$    | $V_{GS} = 0\text{V}, V_{DS} = 25\text{V}, f = 1\text{MHz}$   |                       | 8100 |      | pF                 |
| $C_{oss}$    |  |                       | 1280 |      | pF                 |
| $C_{rss}$    |  |                       | 350  |      | pF                 |
| $R_{Gi}$     | Integrated Gate Input Resistor   |                       | 3.0  |      | $\Omega$           |
| $t_{d(on)}$  | <b>Resistive Switching Times</b><br>$V_{GS} = 10\text{V}, V_{DS} = 0.5 \cdot V_{DSS}, I_D = 0.5 \cdot I_{D25}$<br>$R_G = 0\Omega$ (External) |                       | 23   |      | ns                 |
| $t_r$        |  |                       | 14   |      | ns                 |
| $t_{d(off)}$ |  |                       | 68   |      | ns                 |
| $t_f$        |  |                       | 15   |      | ns                 |
| $Q_{g(on)}$  | $V_{GS} = 10\text{V}, V_{DS} = 0.5 \cdot V_{DSS}, I_D = 0.5 \cdot I_{D25}$   |                       | 215  |      | nC                 |
| $Q_{gs}$     |  |                       | 36   |      | nC                 |
| $Q_{gd}$     |  |                       | 80   |      | nC                 |
| $R_{thJC}$   | TO-247   |                       |      | 0.31 | $^\circ\text{C/W}$ |
| $R_{thCS}$   |  |                       | 0.21 |      | $^\circ\text{C/W}$ |

### Safe Operating Area Specification

| Symbol | Test Conditions   | Characteristic Values |      |      |   |
|--------|---|-----------------------|------|------|---|
|        |   | Min.                  | Typ. | Max. |   |
| SOA    | $V_{DS} = 80\text{V}, I_D = 3\text{A}, T_C = 75^\circ\text{C}, T_P = 5\text{s}$ | 240                   |      |      | W |

### Source-Drain Diode

| Symbol   | Test Conditions<br>( $T_J = 25^\circ\text{C}$ , Unless Otherwise Specified)                       | Characteristic Values |      |      |               |
|----------|---|-----------------------|------|------|---------------|
|          |   | Min.                  | Typ. | Max. |               |
| $I_S$    | $V_{GS} = 0\text{V}$  |                       |      | 75   | A             |
| $I_{SM}$ | Repetitive, Pulse Width Limited by $T_{JM}$   |                       |      | 300  | A             |
| $V_{SD}$ | $I_F = I_S, V_{GS} = 0\text{V}$ , Note 1  |                       |      | 1.4  | V             |
| $t_{rr}$ | $I_F = 37.5\text{A}, -di/dt = 100\text{A}/\mu\text{s},$<br>$V_R = 50\text{V}, V_{GS} = 0\text{V}$ |                       | 180  |      | ns            |
| $I_{RM}$ |   |                       | 16.2 |      | A             |
| $Q_{RM}$ |   |                       | 1.46 |      | $\mu\text{C}$ |

Note 1. Pulse test,  $t \leq 300\mu\text{s}$ ; duty cycle,  $d \leq 2\%$ .

### ADVANCE TECHNICAL INFORMATION

The product presented herein is under development. The Technical Specifications offered are derived from a subjective evaluation of the design, based upon prior knowledge and experience, and constitute a "considered reflection" of the anticipated result. IXYS reserves the right to change limits, test conditions, and dimensions without notice.

IXYS Reserves the Right to Change Limits, Test Conditions, and Dimensions.

IXYS MOSFETs and IGBTs are covered by one or more of the following U.S. patents:

|           |           |           |           |              |              |              |              |              |             |
|-----------|-----------|-----------|-----------|--------------|--------------|--------------|--------------|--------------|-------------|
| 4,835,592 | 4,931,844 | 5,049,961 | 5,237,481 | 6,162,665    | 6,404,065 B1 | 6,683,344    | 6,727,585    | 7,005,734 B2 | 7,157,338B2 |
| 4,850,072 | 5,017,508 | 5,063,307 | 5,381,025 | 6,259,123 B1 | 6,534,343    | 6,710,405 B2 | 6,759,692    | 7,063,975 B2 |             |
| 4,881,106 | 5,034,796 | 5,187,117 | 5,486,715 | 6,306,728 B1 | 6,583,505    | 6,710,463    | 6,771,478 B2 | 7,071,537    |             |

### TO-247 (IXTH) Outline

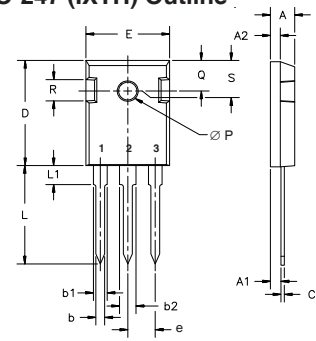

Terminals: 1 - Gate  
2 - Drain  
3 - Source  
Tab - Drain

| Dim.           | Millimeter |       | Inches |       |
|----------------|------------|-------|--------|-------|
|                | Min.       | Max.  | Min.   | Max.  |
| A              | 4.7        | 5.3   | .185   | .209  |
| A <sub>1</sub> | 2.2        | 2.54  | .087   | .102  |
| A <sub>2</sub> | 2.2        | 2.6   | .059   | .098  |
| b              | 1.0        | 1.4   | .040   | .055  |
| b <sub>1</sub> | 1.65       | 2.13  | .065   | .084  |
| b <sub>2</sub> | 2.87       | 3.12  | .113   | .123  |
| C              | .4         | .8    | .016   | .031  |
| D              | 20.80      | 21.46 | .819   | .845  |
| E              | 15.75      | 16.26 | .610   | .640  |
| e              | 5.20       | 5.72  | 0.205  | 0.225 |
| L              | 19.81      | 20.32 | .780   | .800  |
| L <sub>1</sub> |            | 4.50  |        | .177  |
| ∅P             | 3.55       | 3.65  | .140   | .144  |
| Q              | 5.89       | 6.40  | 0.232  | 0.252 |
| R              | 4.32       | 5.49  | .170   | .216  |
| S              | 6.15       | BSC   | 242    | BSC   |

### TO-268 (IXTT) Outline

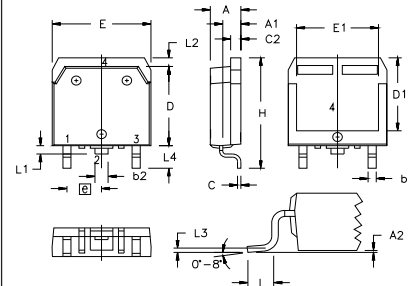

Terminals: 1 - Gate  
2 - Drain  
3 - Source  
Tab - Drain

| SYM            | INCHES   |      | MILLIMETERS |       |
|----------------|----------|------|-------------|-------|
|                | MIN      | MAX  | MIN         | MAX   |
| A              | .193     | .201 | 4.90        | 5.10  |
| A <sub>1</sub> | .106     | .114 | 2.70        | 2.90  |
| A <sub>2</sub> | .001     | .010 | 0.02        | 0.25  |
| b              | .045     | .057 | 1.15        | 1.45  |
| b <sub>2</sub> | .075     | .083 | 1.90        | 2.10  |
| C              | .016     | .026 | 0.40        | 0.65  |
| C <sub>2</sub> | .057     | .063 | 1.45        | 1.60  |
| D              | .543     | .551 | 13.80       | 14.00 |
| D <sub>1</sub> | .488     | .500 | 12.40       | 12.70 |
| E              | .624     | .632 | 15.85       | 16.05 |
| E <sub>1</sub> | .524     | .535 | 13.30       | 13.60 |
| e              | .215 BSC |      | 5.45 BSC    |       |
| H              | .736     | .752 | 18.70       | 19.10 |
| L              | .094     | .106 | 2.40        | 2.70  |
| L <sub>1</sub> | .047     | .055 | 1.20        | 1.40  |
| L <sub>2</sub> | .039     | .045 | 1.00        | 1.15  |
| L <sub>3</sub> | .010 BSC |      | 0.25 BSC    |       |
| L <sub>4</sub> | .150     | .161 | 3.80        | 4.10  |

Fig. 1. Output Characteristics @  $T_J = 25^\circ\text{C}$

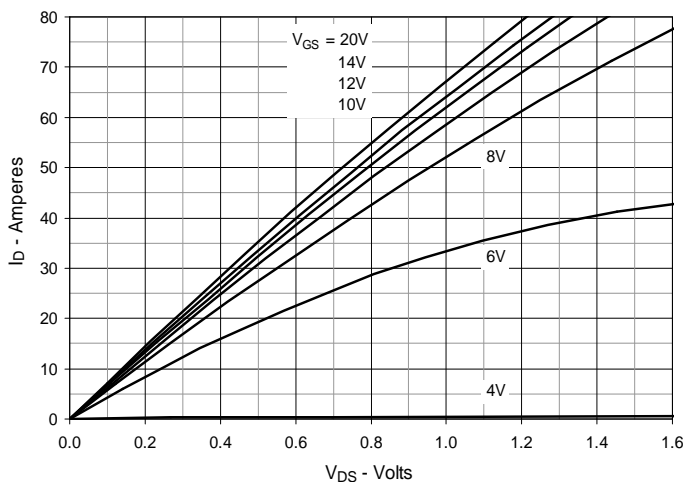

Fig. 2. Extended Output Characteristics @  $T_J = 25^\circ\text{C}$

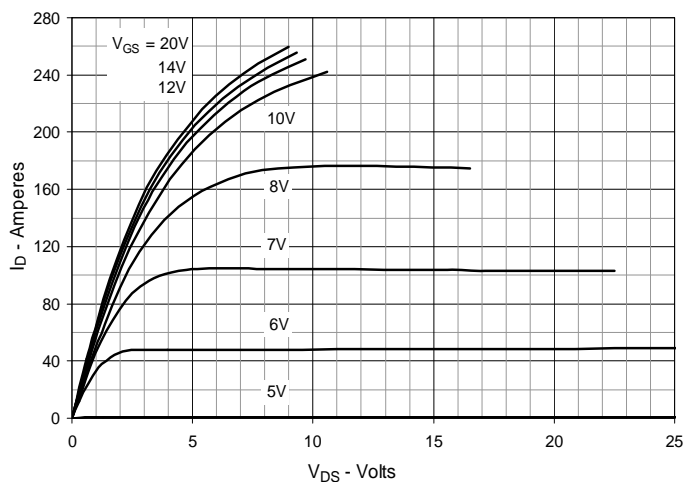

Fig. 3. Output Characteristics @  $T_J = 125^\circ\text{C}$

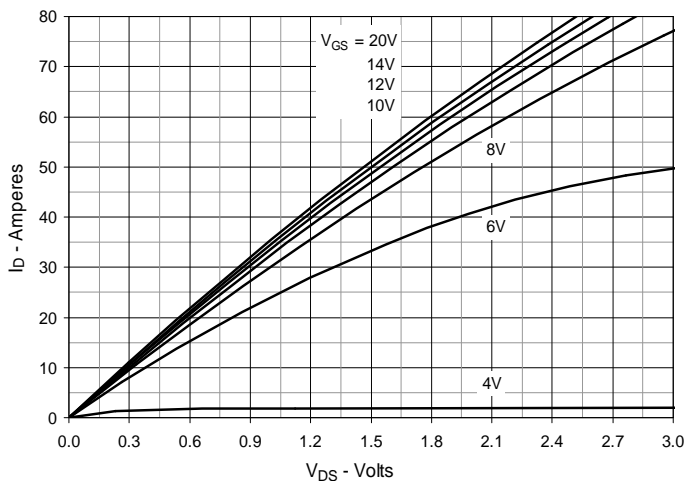

Fig. 4.  $R_{DS(on)}$  Normalized to  $I_D = 37.5\text{A}$  Value vs. Junction Temperature

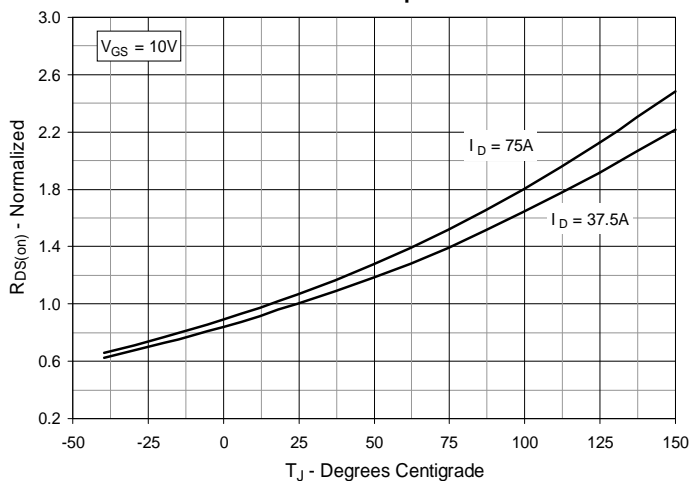

Fig. 5.  $R_{DS(on)}$  Normalized to  $I_D = 37.5\text{A}$  Value vs. Drain Current

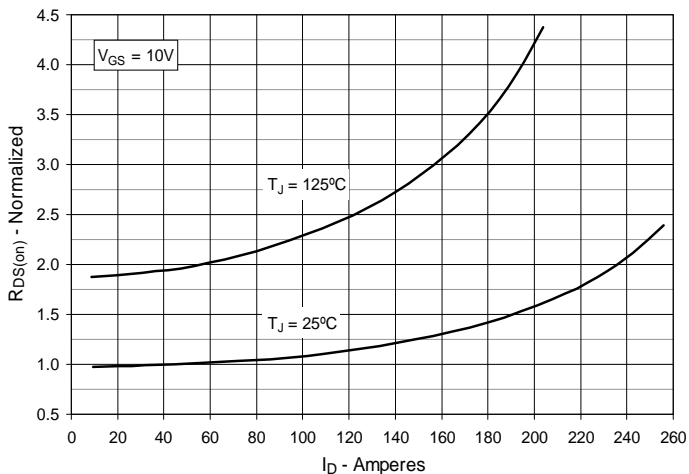

Fig. 6. Maximum Drain Current vs. Case Temperature

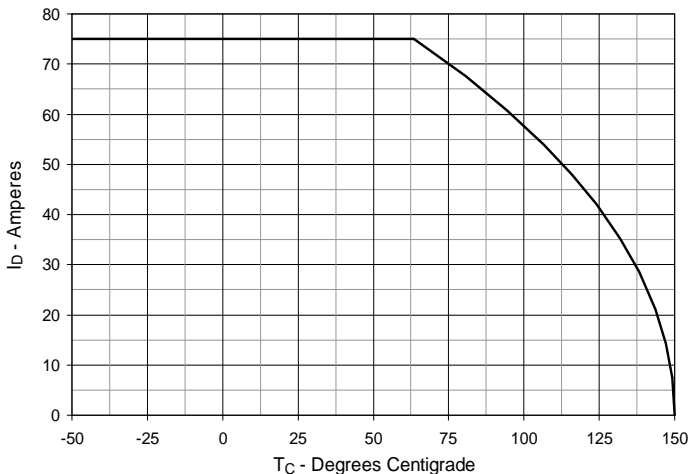

Fig. 7. Input Admittance

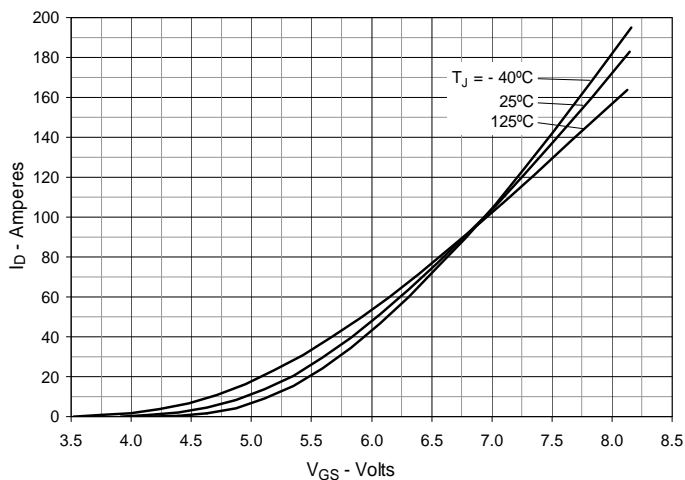

Fig. 8. Transconductance

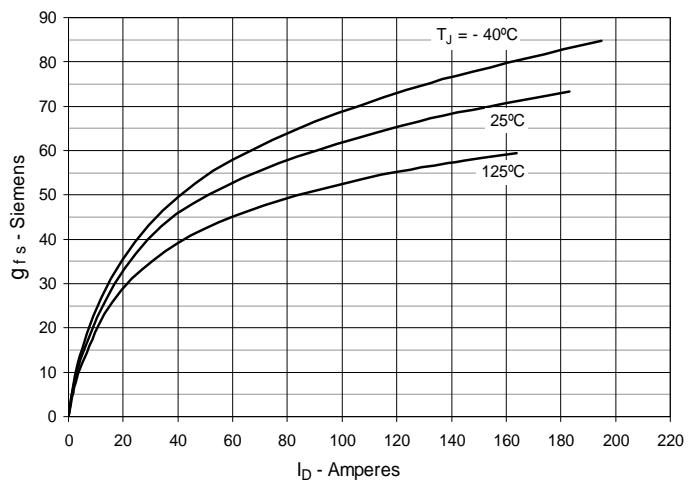

Fig. 9. Forward Voltage Drop of Intrinsic Diode

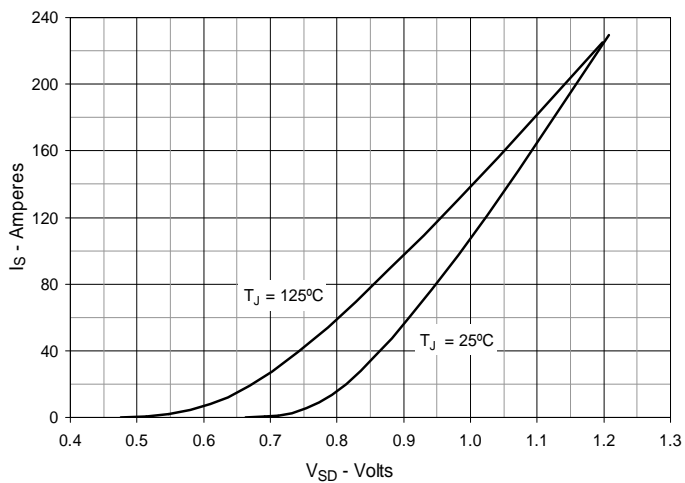

Fig. 10. Gate Charge

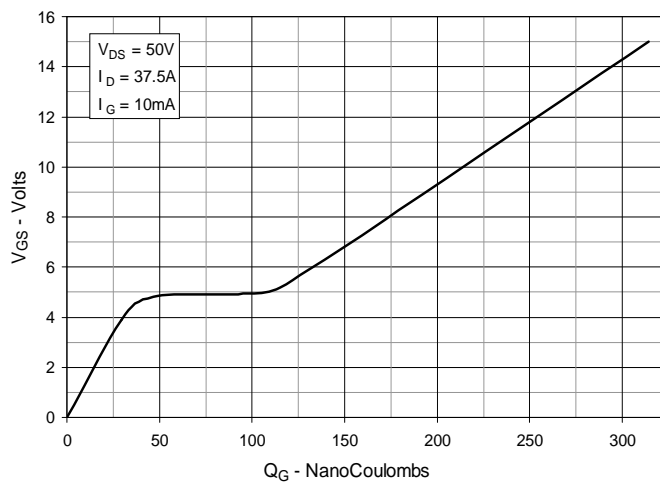

Fig. 11. Capacitance

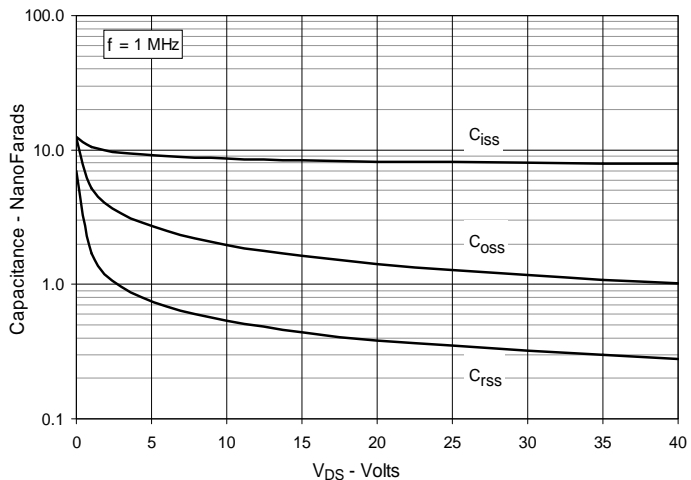
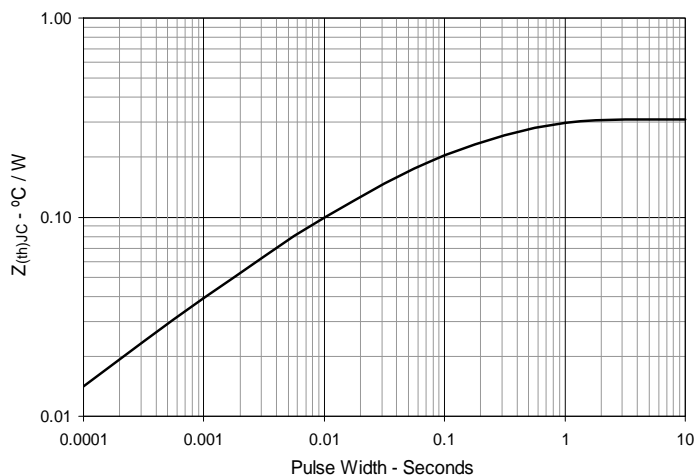
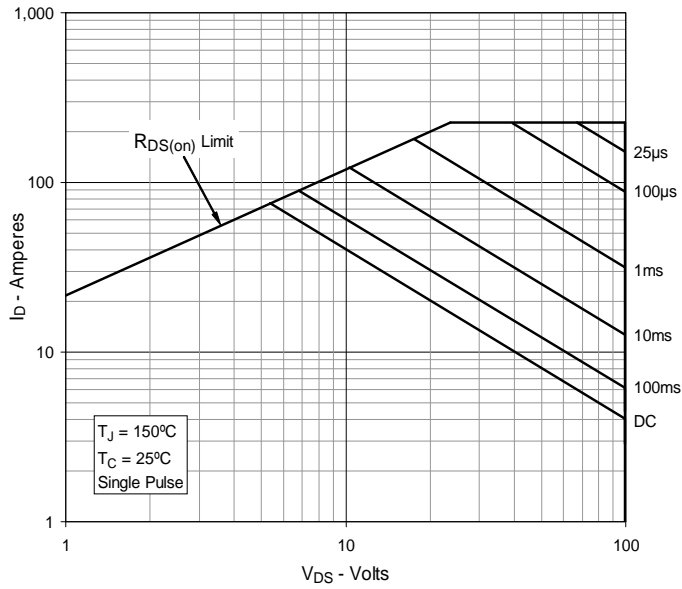

Fig. 12. Maximum Transient Thermal Impedance



**Fig. 13. Forward-Bias Safe Operating Area**  
@  $T_C = 25^\circ\text{C}$



**Fig. 14. Forward-Bias Safe Operating Area**  
@  $T_C = 75^\circ\text{C}$

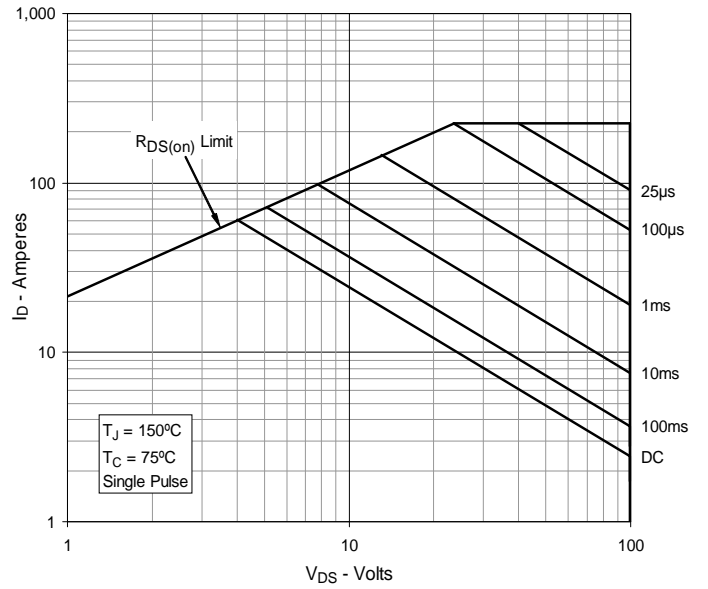



---

Disclaimer Notice - Information furnished is believed to be accurate and reliable. However, users should independently evaluate the suitability of and test each product selected for their own applications. Littelfuse products are not designed for, and may not be used in, all applications. Read complete Disclaimer Notice at [www.littelfuse.com/disclaimer-electronics](http://www.littelfuse.com/disclaimer-electronics).