

**Polar™  
Power MOSFET**
**IXTS01N90P-89  
IXTS01N90P-223**

$$V_{DSS} = 900V$$

$$I_{D25} = 100mA$$

$$R_{DS(on)} \leq 75\Omega$$

N-Channel Enhancement Mode

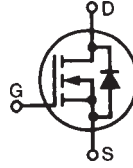

Symbol	Test Conditions	Maximum Ratings	
$V_{DSS}$	$T_J = 25^\circ C$ to $150^\circ C$	900	V
$V_{DGR}$	$T_J = 25^\circ C$ to $150^\circ C$ , $R_{GS} = 1M\Omega$	900	V
$V_{GSS}$	Continuous	$\pm 20$	V
$V_{GSM}$	Transient	$\pm 30$	V
$I_{D25}$	$T_C = 25^\circ C$	100	mA
$I_{DM}$	$T_C = 25^\circ C$ , Pulse Width Limited by $T_{JM}$	450	mA
$dv/dt$	$I_S \leq I_{DM}$ , $V_{DD} \leq V_{DSS}$ , $T_J \leq 150^\circ C$	10	V/ns
$P_D$	$T_C = 25^\circ C$	25	W
$T_J$		-55 ... +150	$^\circ C$
$T_{JM}$		150	$^\circ C$
$T_{stg}$		-55 ... +150	$^\circ C$
$T_L$	Maximum Lead Temperature for Soldering	300	$^\circ C$
$T_{SOLD}$	1.6 mm (0.062in.) from Case for 10s	260	$^\circ C$
<b>Weight</b>	SOT-89	0.35	g
	SOT-223	0.40	g

SOT-89

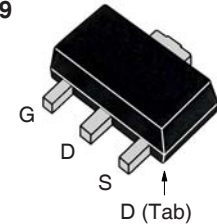

SOT-223

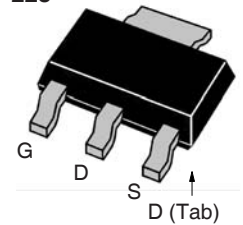

G = Gate      D = Drain  
S = Source    Tab = Drain

**Features**

- High Voltage, Low Leakage Mosfet in SMD Package
- Suitable for  $V_{GE} = 5V$  Drive

**Applications**

- DC-DC Converters
- Switch-Mode and Resonant-Mode Power Supplies
- Protection Circuits

Symbol	Test Conditions ( $T_J = 25^\circ C$ , Unless Otherwise Specified)	Characteristic Values		
		Min.	Typ.	Max.
$BV_{DSS}$	$V_{GS} = 0V$ , $I_D = 250\mu A$	900		V
$V_{GS(th)}$	$V_{DS} = V_{GS}$ , $I_D = 100\mu A$	1.5		3.0 V
$I_{GSS}$	$V_{GS} = \pm 20V$ , $V_{DS} = 0V$			$\pm 25$ nA
$I_{DSS}$	$V_{DS} = V_{DSS}$ , $V_{GS} = 0V$ $T_J = 125^\circ C$			25 nA 2 $\mu A$
$R_{DS(on)}$	$V_{GS} = 5V$ , $I_D = 0.5 \cdot I_{D25}$ , Note 1		64	77 $\Omega$
	$V_{GS} = 10V$ , $I_D = 0.5 \cdot I_{D25}$ , Note 1		62	75 $\Omega$

Symbol	Test Conditions ( $T_J = 25^\circ\text{C}$ , Unless Otherwise Specified)	Characteristic Values		
		Min.	Typ.	Max
$g_{fs}$	$V_{DS} = 50\text{V}$ , $I_D = 0.5 \cdot I_{D25}$ , Note 1	70	120	mS
$C_{iss}$	$V_{GS} = 0\text{V}$ , $V_{DS} = 25\text{V}$ , $f = 1\text{MHz}$		82.0	pF
$C_{oss}$			5.7	pF
$C_{rss}$			1.4	pF
$t_{d(on)}$	<b>Resistive Switching Times</b> $V_{GS} = 10\text{V}$ , $V_{DS} = 50\text{V}$ , $I_D = 0.5 \cdot I_{D25}$ $R_G = 50\Omega$ (External)		5	ns
$t_r$			20	ns
$t_{d(off)}$			30	ns
$t_f$			65	ns
$Q_{g(on)}$	$V_{GS} = 10\text{V}$ , $V_{DS} = 0.5 \cdot V_{DSS}$ , $I_D = 0.5 \cdot I_{D25}$		2.2	nC
$Q_{gs}$			0.4	nC
$Q_{gd}$			0.7	nC
$R_{thJC}$				5.0 °C/W

#### Source-Drain Diode

Symbol	Test Conditions ( $T_J = 25^\circ\text{C}$ , Unless Otherwise Specified)	Characteristic Values		
		Min.	Typ.	Max
$I_S$	$V_{GS} = 0\text{V}$			100 mA
$I_{SM}$	Repetitive, pulse Width Limited by $T_{JM}$			400 mA
$V_{SD}$	$I_F = I_S$ , $V_{GS} = 0\text{V}$ , Note 1			1.4 V
$t_{rr}$	$I_F = 1\text{A}$ , $-di/dt = 100\text{A}/\mu\text{s}$ $V_R = 100\text{V}$		285	ns
$Q_{RM}$			860	nC
$I_{RM}$			6	A

Note 1. Pulse test,  $t \leq 300\mu\text{s}$ , duty cycle,  $d \leq 2\%$ .

#### **ADVANCE TECHNICAL INFORMATION**

The product presented herein is under development. The Technical Specifications offered are derived from a subjective evaluation of the design, based upon prior knowledge and experience, and constitute a "considered reflection" of the anticipated result. IXYS reserves the right to change limits, test conditions, and dimensions without notice.

IXYS Reserves the Right to Change Limits, Test Conditions, and Dimensions.

IXYS MOSFETs and IGBTs are covered by one or more of the following U.S. patents:	4,835,592	4,931,844	5,049,961	5,237,481	6,162,665	6,404,065B1	6,683,344	6,727,585	7,005,734B2	7,157,338B2
	4,860,072	5,017,508	5,063,307	5,381,025	6,259,123B1	6,534,343	6,710,405B2	6,759,692	7,063,975B2	
	4,881,106	5,034,796	5,187,117	5,486,715	6,306,728B1	6,583,505	6,710,463	6,771,478B2	7,071,537	

**Fig. 1. Output Characteristics @  $T_J = 25^\circ\text{C}$**

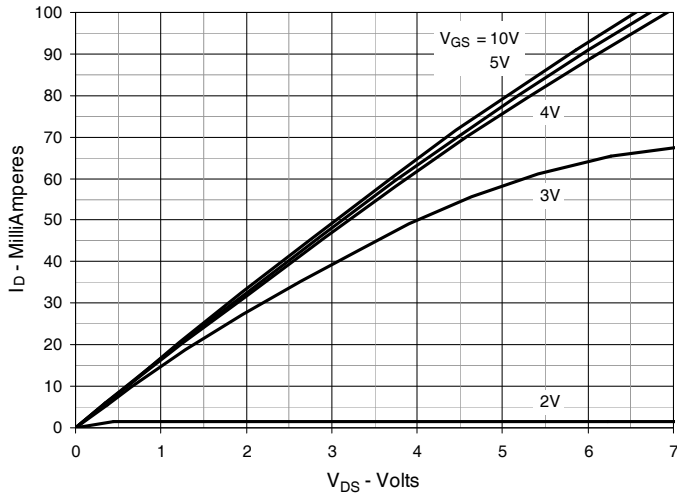

**Fig. 2. Extended Output Characteristics @  $T_J = 25^\circ\text{C}$**

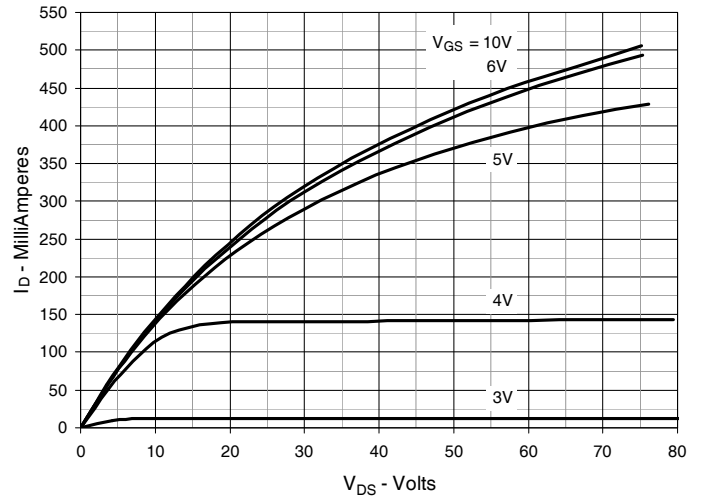

**Fig. 3. Output Characteristics @  $T_J = 125^\circ\text{C}$**

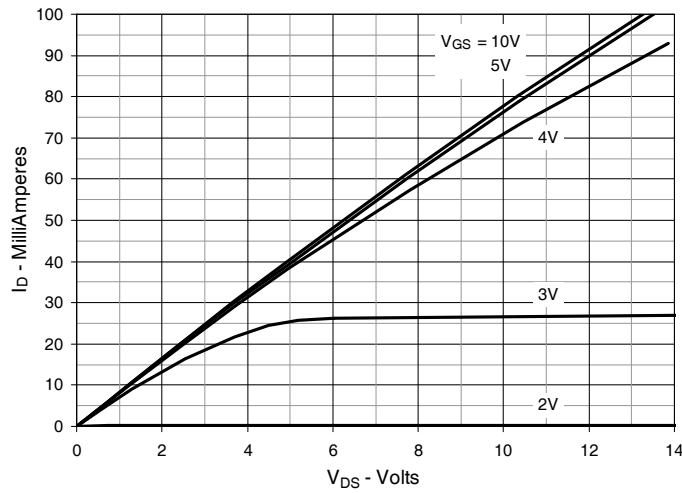

**Fig. 4.  $R_{DS(on)}$  Normalized to  $I_D = 50\text{mA}$  Value vs. Junction Temperature**

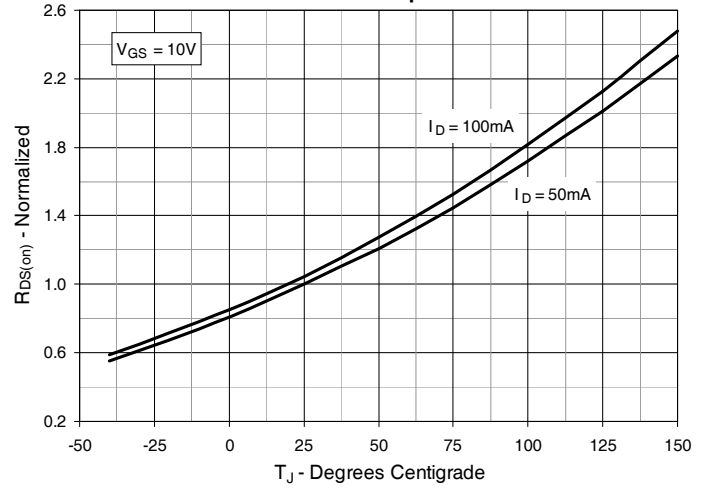

**Fig. 5.  $R_{DS(on)}$  Normalized to  $I_D = 50\text{mA}$  Value vs. Drain Current**

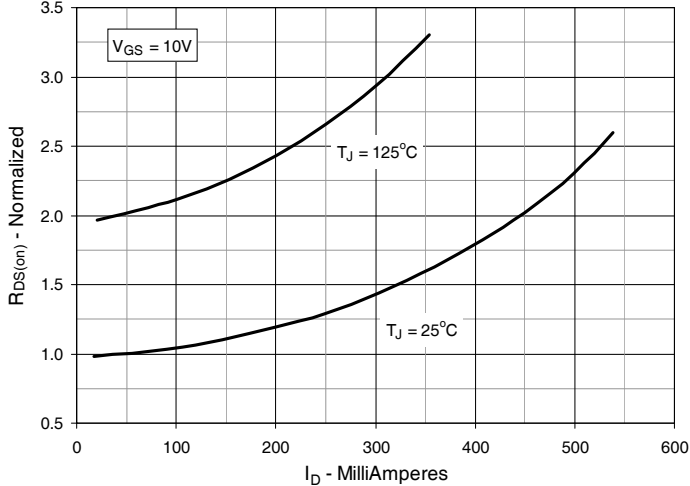

**Fig. 6. Normalized Breakdown & Threshold Voltages vs. Junction Temperature**

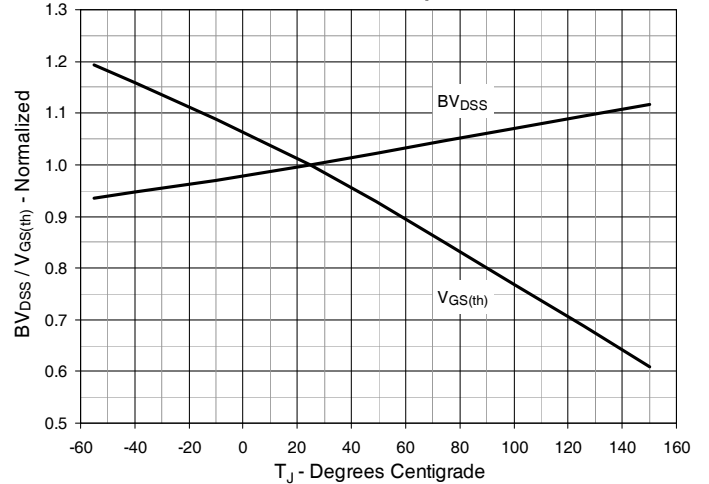

**Fig. 7. Maximum Drain Current vs. Case Temperature**

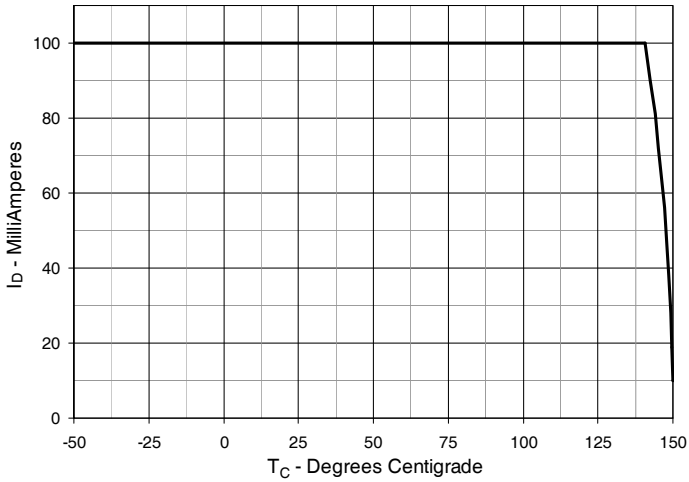

**Fig. 8. Input Admittance**

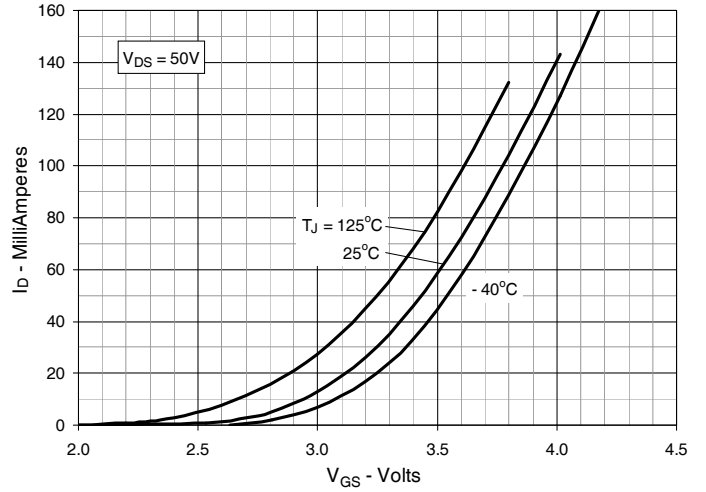

**Fig. 9. Transconductance**

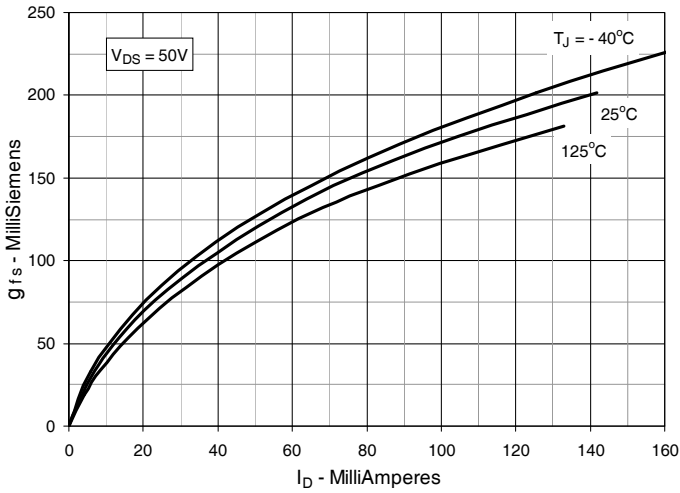

**Fig. 10. Forward Voltage Drop of Intrinsic Diode**

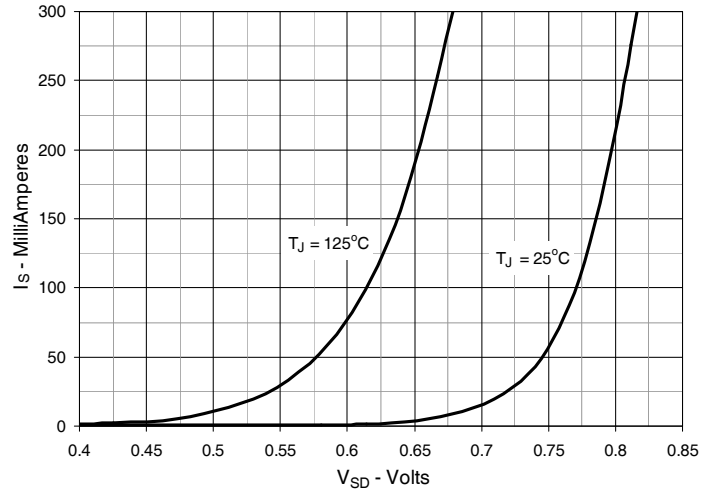

**Fig. 11. Gate Charge**

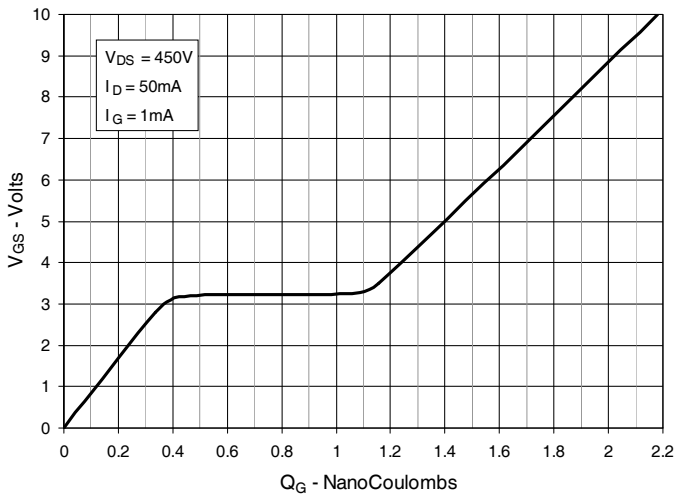

**Fig. 12. Capacitance**

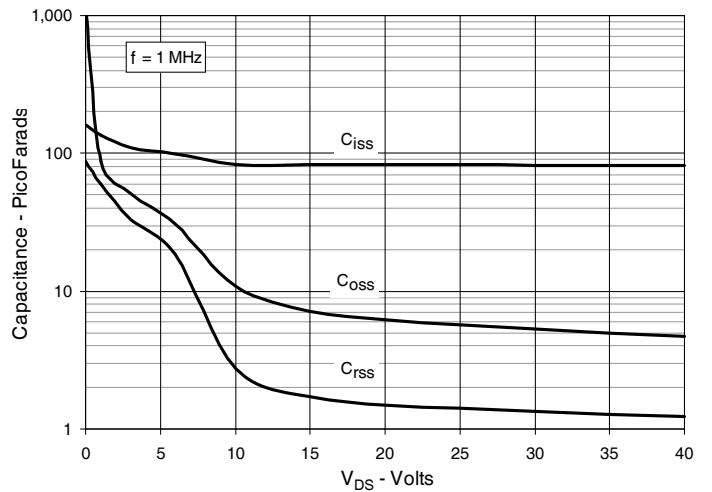

**Fig. 13. Forward-Bias Safe Operating Area**

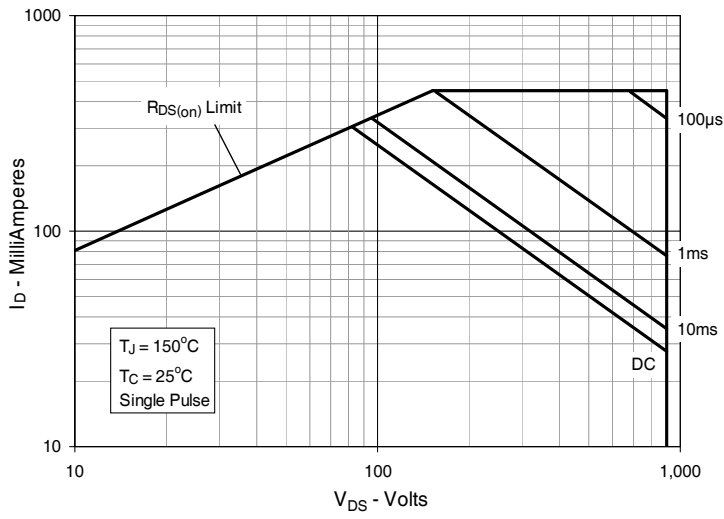

**Fig. 14. Maximum Transient Thermal Impedance**

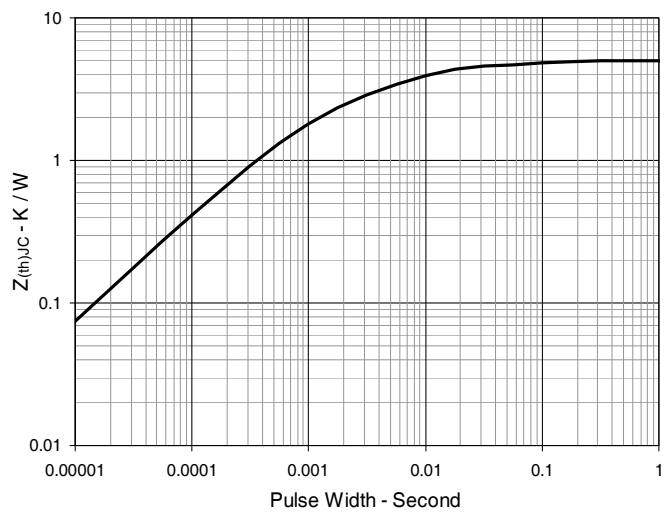

**SOT-89 Outline**

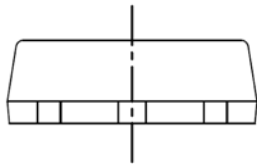
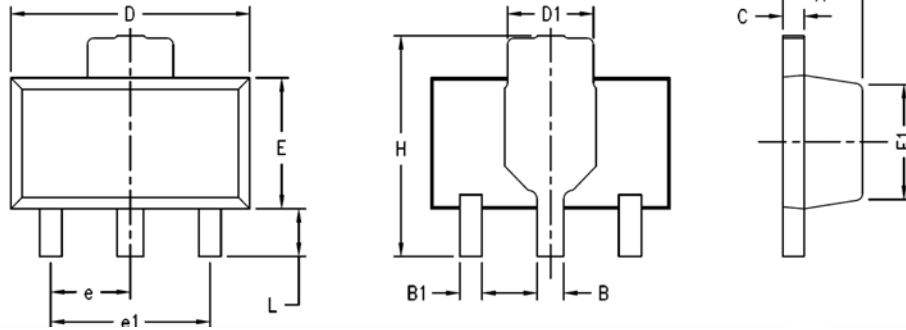

NOTE:  
1. All leads are matte pure tin plated.

SYM	INCHES		MILLI METER	
	MIN	MAX	MIN	MAX
A	0.055	0.063	1.40	1.60
B	0.017	0.022	0.43	0.56
B1	0.014	0.019	0.36	0.48
C	0.014	0.017	0.36	0.43
D	0.173	0.181	4.39	4.60
D1	0.066	0.070	1.67	1.78
E	0.090	0.099	2.29	2.51
E1	0.084	0.086	2.13	2.18
e	0.059		1.50	
e1	0.118		3.00	
H	0.155	0.167	3.93	4.24
L	0.029	0.041	0.74	1.04

**SOT-223 Outline**

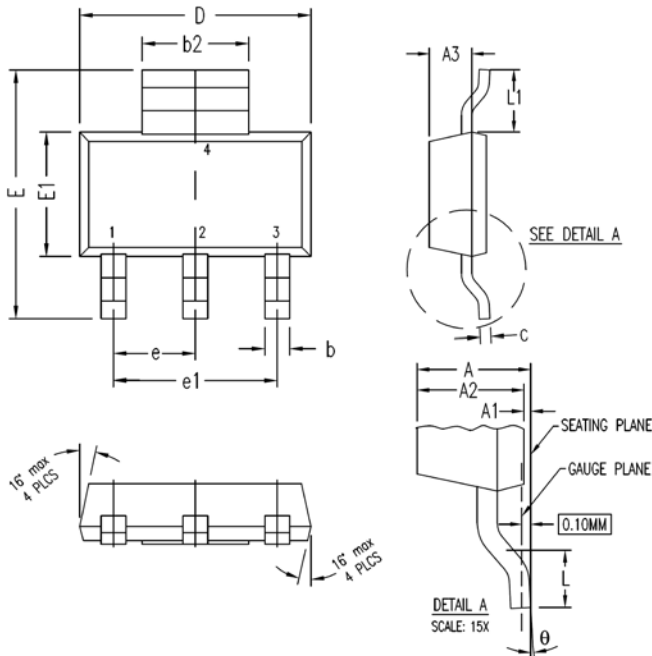

SYM	INCHES		MILLIMETERS	
	MIN	MAX	MIN	MAX
A	0.063	0.071	1.60	1.80
A1	0.001	0.005	0.02	0.13
A2	0.059	0.067	1.50	1.70
A3	0.043	0.051	1.10	1.30
b	0.026	0.033	0.66	0.84
b2	0.116	0.124	2.95	3.15
c	0.009	0.015	0.24	0.38
D	0.248	0.264	6.30	6.70
E	0.264	0.287	6.70	7.30
E1	0.130	0.146	3.30	3.70
e	0.087	0.094	2.20	2.40
e1	0.177	0.185	4.50	4.70
L	0.024	0.036	0.62	0.92
L1	0.065	0.073	1.65	1.85
θ	0°	10°	0°	10°



---

Disclaimer Notice - Information furnished is believed to be accurate and reliable. However, users should independently evaluate the suitability of and test each product selected for their own applications. Littelfuse products are not designed for, and may not be used in, all applications. Read complete Disclaimer Notice at [www.littelfuse.com/disclaimer-electronics](http://www.littelfuse.com/disclaimer-electronics).