

Polar™
Power MOSFET
IxTS01N90P-89
IxTS01N90P-223

$$V_{DSS} = 900V$$

$$I_{D25} = 100mA$$

$$R_{DS(on)} \leq 75\Omega$$

N-Channel Enhancement Mode



Symbol	Test Conditions	Maximum Ratings	
V_{DSS}	$T_J = 25^\circ C$ to $150^\circ C$	900	V
V_{DGR}	$T_J = 25^\circ C$ to $150^\circ C$, $R_{GS} = 1M\Omega$	900	V
V_{GSS}	Continuous	± 20	V
V_{GSM}	Transient	± 30	V
I_{D25}	$T_C = 25^\circ C$	100	mA
I_{DM}	$T_C = 25^\circ C$, Pulse Width Limited by T_{JM}	450	mA
dv/dt	$I_S \leq I_{DM}$, $V_{DD} \leq V_{DSS}$, $T_J \leq 150^\circ C$	10	V/ns
P_D	$T_C = 25^\circ C$	25	W
T_J		-55 ... +150	$^\circ C$
T_{JM}		150	$^\circ C$
T_{stg}		-55 ... +150	$^\circ C$
T_L	Maximum Lead Temperature for Soldering	300	$^\circ C$
T_{SOLD}	1.6 mm (0.062in.) from Case for 10s	260	$^\circ C$
Weight	SOT-89	0.35	g
	SOT-223	0.40	g

SOT-89

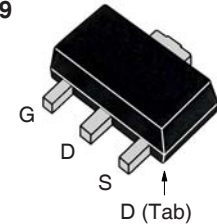

SOT-223

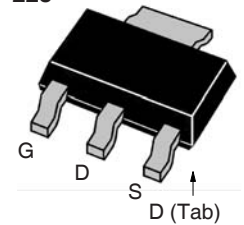

G = Gate D = Drain
 S = Source Tab = Drain

Features

- High Voltage, Low Leakage Mosfet in SMD Package
- Suitable for $V_{GE} = 5V$ Drive

Applications

- DC-DC Converters
- Switch-Mode and Resonant-Mode Power Supplies
- Protection Circuits

Symbol	Test Conditions ($T_J = 25^\circ C$, Unless Otherwise Specified)	Characteristic Values		
		Min.	Typ.	Max.
BV_{DSS}	$V_{GS} = 0V$, $I_D = 250\mu A$	900		V
$V_{GS(th)}$	$V_{DS} = V_{GS}$, $I_D = 100\mu A$	1.5		3.0 V
I_{GSS}	$V_{GS} = \pm 20V$, $V_{DS} = 0V$			± 25 nA
I_{DSS}	$V_{DS} = V_{DSS}$, $V_{GS} = 0V$ $T_J = 125^\circ C$			25 nA 2 μA
$R_{DS(on)}$	$V_{GS} = 5V$, $I_D = 0.5 \cdot I_{D25}$, Note 1		64	77 Ω
	$V_{GS} = 10V$, $I_D = 0.5 \cdot I_{D25}$, Note 1		62	75 Ω

Symbol	Test Conditions ($T_J = 25^\circ\text{C}$, Unless Otherwise Specified)	Characteristic Values		
		Min.	Typ.	Max
g_{fs}	$V_{DS} = 50\text{V}$, $I_D = 0.5 \cdot I_{D25}$, Note 1	70	120	mS
C_{iss}	$V_{GS} = 0\text{V}$, $V_{DS} = 25\text{V}$, $f = 1\text{MHz}$		82.0	pF
C_{oss}			5.7	pF
C_{rss}			1.4	pF
$t_{d(on)}$	Resistive Switching Times $V_{GS} = 10\text{V}$, $V_{DS} = 50\text{V}$, $I_D = 0.5 \cdot I_{D25}$ $R_G = 50\Omega$ (External)		5	ns
t_r			20	ns
$t_{d(off)}$			30	ns
t_f			65	ns
$Q_{g(on)}$	$V_{GS} = 10\text{V}$, $V_{DS} = 0.5 \cdot V_{DSS}$, $I_D = 0.5 \cdot I_{D25}$		2.2	nC
Q_{gs}			0.4	nC
Q_{gd}			0.7	nC
R_{thJC}				5.0 °C/W

Source-Drain Diode

Symbol	Test Conditions ($T_J = 25^\circ\text{C}$, Unless Otherwise Specified)	Characteristic Values		
		Min.	Typ.	Max
I_S	$V_{GS} = 0\text{V}$			100 mA
I_{SM}	Repetitive, pulse Width Limited by T_{JM}			400 mA
V_{SD}	$I_F = I_S$, $V_{GS} = 0\text{V}$, Note 1			1.4 V
t_{rr}	$I_F = 1\text{A}$, $-di/dt = 100\text{A}/\mu\text{s}$ $V_R = 100\text{V}$		285	ns
Q_{RM}			860	nC
I_{RM}			6	A

Note 1. Pulse test, $t \leq 300\mu\text{s}$, duty cycle, $d \leq 2\%$.

ADVANCE TECHNICAL INFORMATION

The product presented herein is under development. The Technical Specifications offered are derived from a subjective evaluation of the design, based upon prior knowledge and experience, and constitute a "considered reflection" of the anticipated result. IXYS reserves the right to change limits, test conditions, and dimensions without notice.

IXYS Reserves the Right to Change Limits, Test Conditions, and Dimensions.

IXYS MOSFETs and IGBTs are covered by one or more of the following U.S. patents:	4,835,592	4,931,844	5,049,961	5,237,481	6,162,665	6,404,065B1	6,683,344	6,727,585	7,005,734B2	7,157,338B2
	4,860,072	5,017,508	5,063,307	5,381,025	6,259,123B1	6,534,343	6,710,405B2	6,759,692	7,063,975B2	
	4,881,106	5,034,796	5,187,117	5,486,715	6,306,728B1	6,583,505	6,710,463	6,771,478B2	7,071,537	

Fig. 1. Output Characteristics @ $T_J = 25^\circ\text{C}$

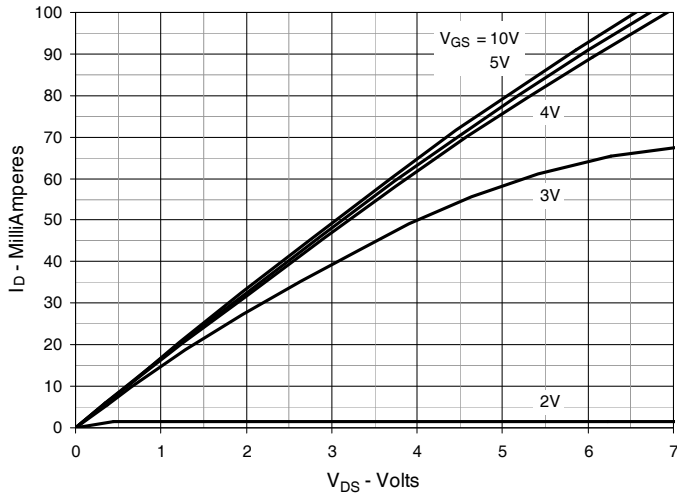

Fig. 2. Extended Output Characteristics @ $T_J = 25^\circ\text{C}$

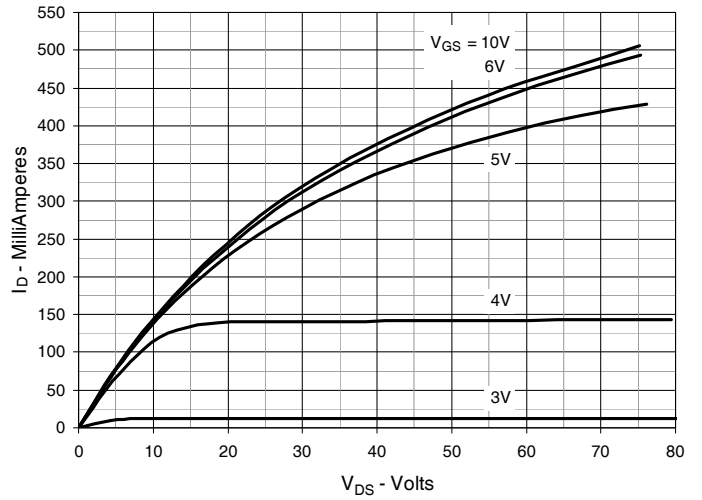

Fig. 3. Output Characteristics @ $T_J = 125^\circ\text{C}$

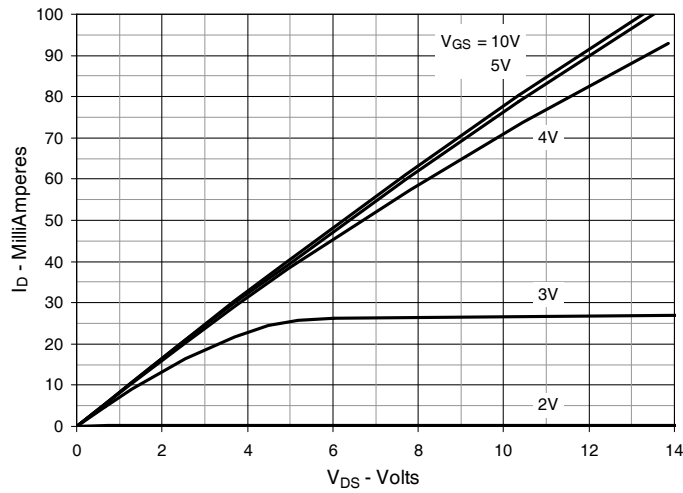

Fig. 4. $R_{DS(on)}$ Normalized to $I_D = 50\text{mA}$ Value vs. Junction Temperature

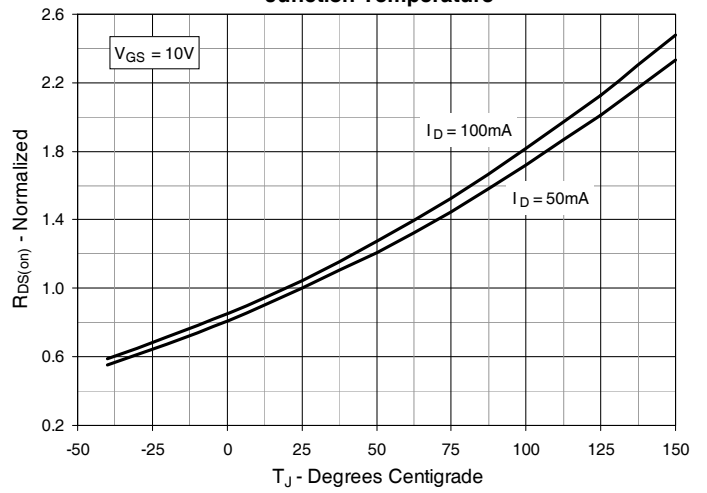

Fig. 5. $R_{DS(on)}$ Normalized to $I_D = 50\text{mA}$ Value vs. Drain Current

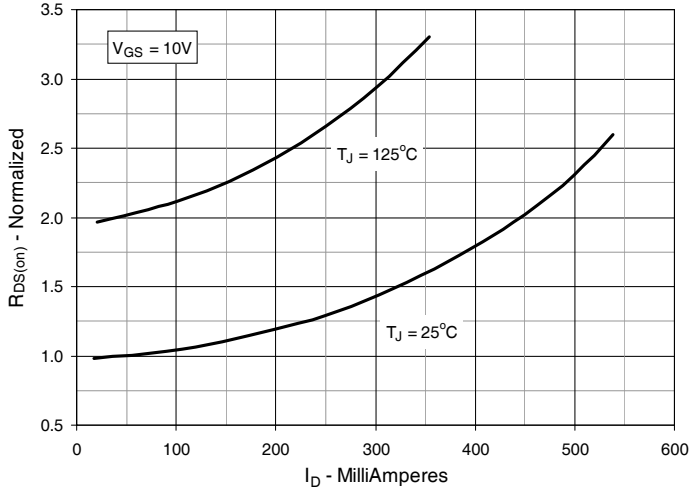

Fig. 6. Normalized Breakdown & Threshold Voltages vs. Junction Temperature

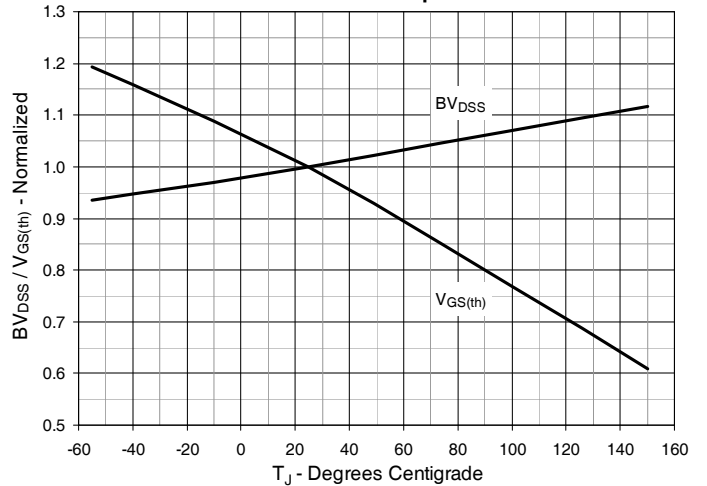

Fig. 7. Maximum Drain Current vs. Case Temperature

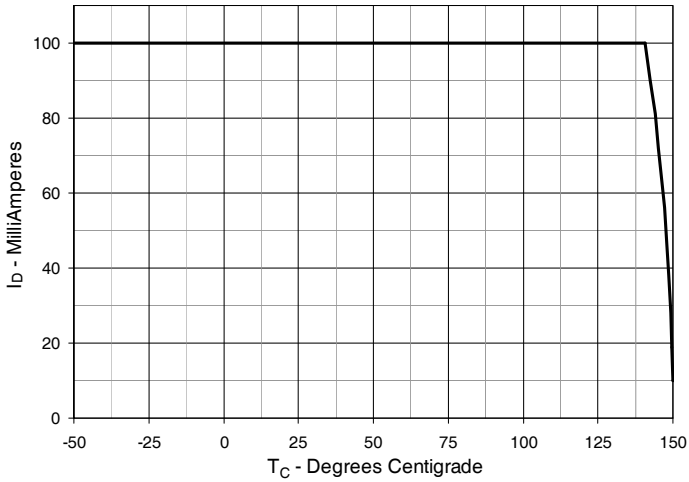

Fig. 8. Input Admittance

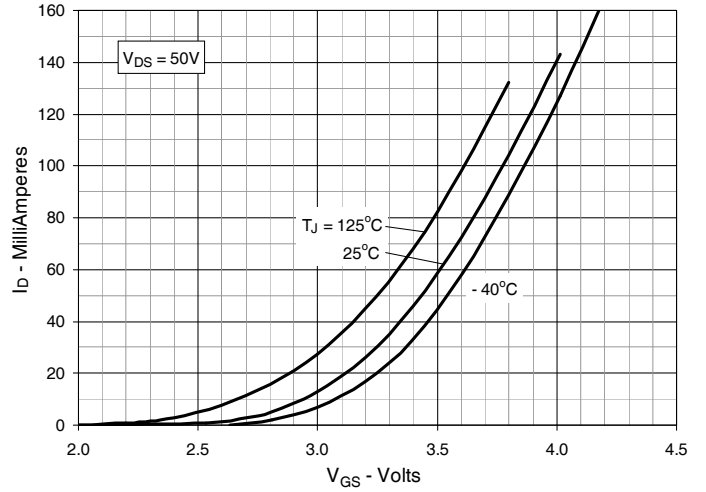

Fig. 9. Transconductance

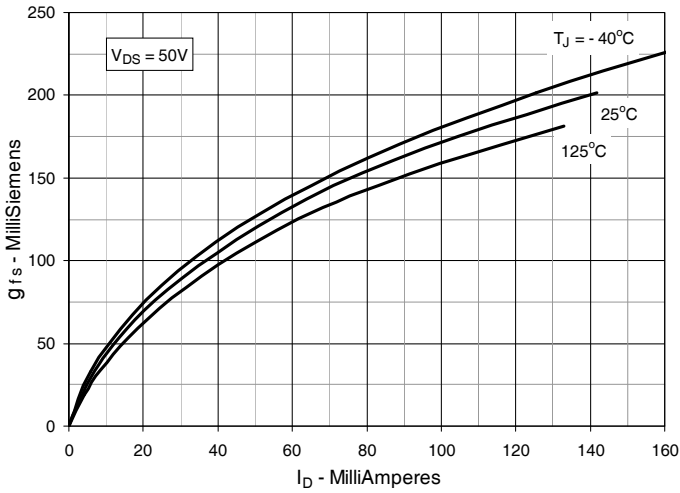

Fig. 10. Forward Voltage Drop of Intrinsic Diode

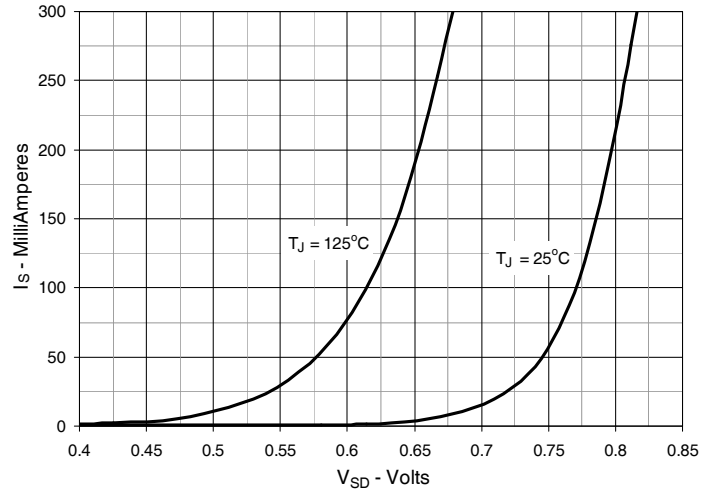

Fig. 11. Gate Charge

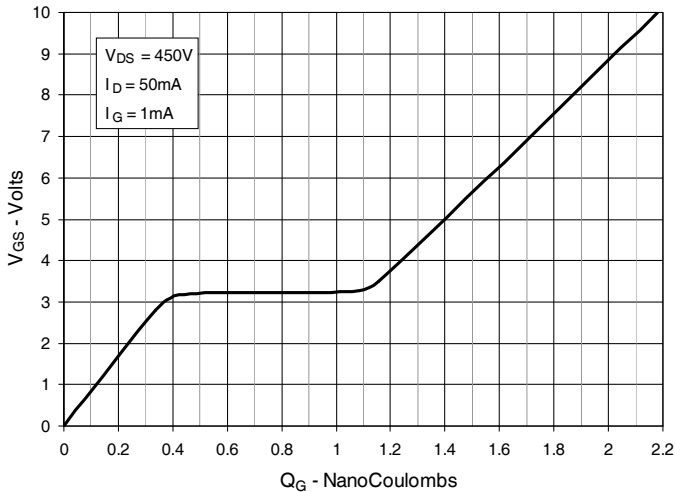

Fig. 12. Capacitance

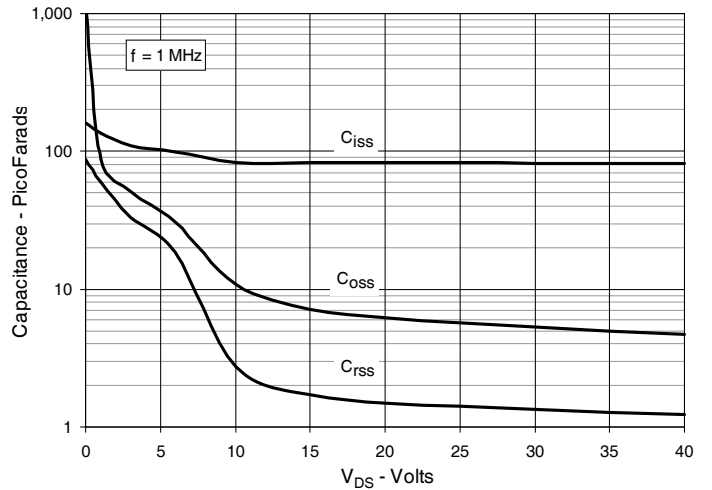

Fig. 13. Forward-Bias Safe Operating Area

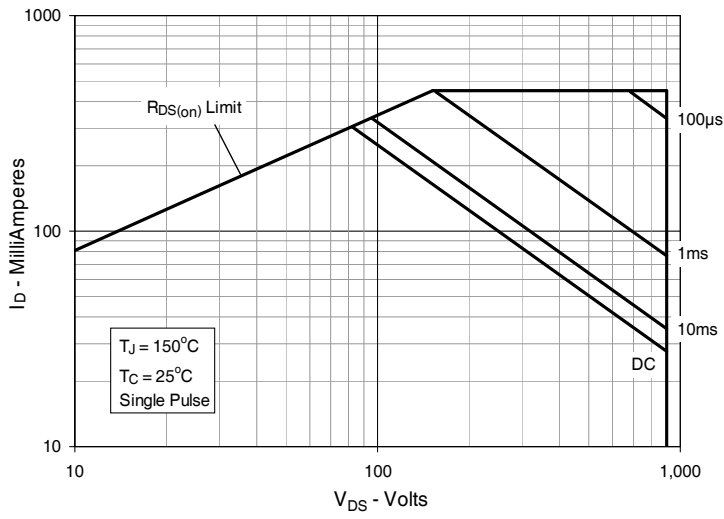
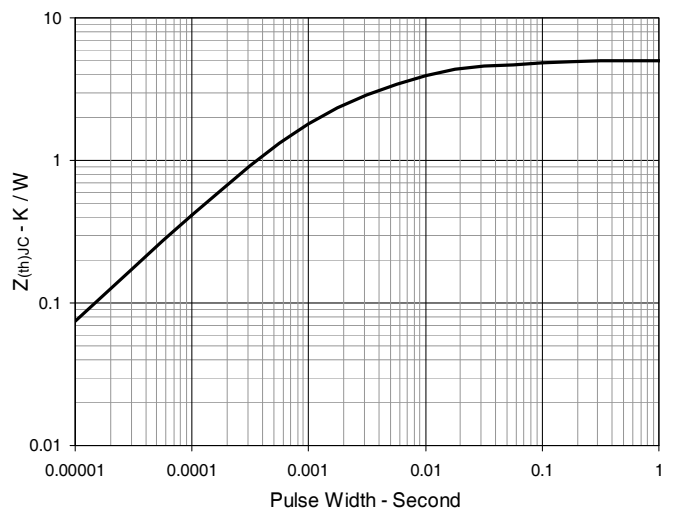
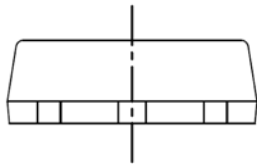
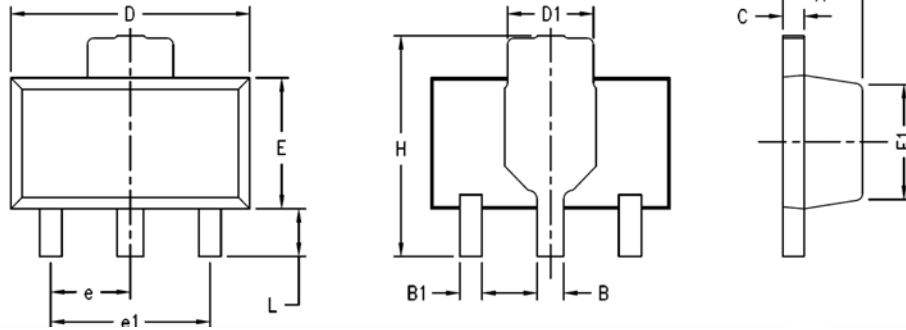

Fig. 14. Maximum Transient Thermal Impedance



SOT-89 Outline



NOTE:
1. All leads are matte pure tin plated.

SYM	INCHES		MILLI METER	
	MIN	MAX	MIN	MAX
A	0.055	0.063	1.40	1.60
B	0.017	0.022	0.43	0.56
B1	0.014	0.019	0.36	0.48
C	0.014	0.017	0.36	0.43
D	0.173	0.181	4.39	4.60
D1	0.066	0.070	1.67	1.78
E	0.090	0.099	2.29	2.51
E1	0.084	0.086	2.13	2.18
e	0.059		1.50	
e1	0.118		3.00	
H	0.155	0.167	3.93	4.24
L	0.029	0.041	0.74	1.04

SOT-223 Outline

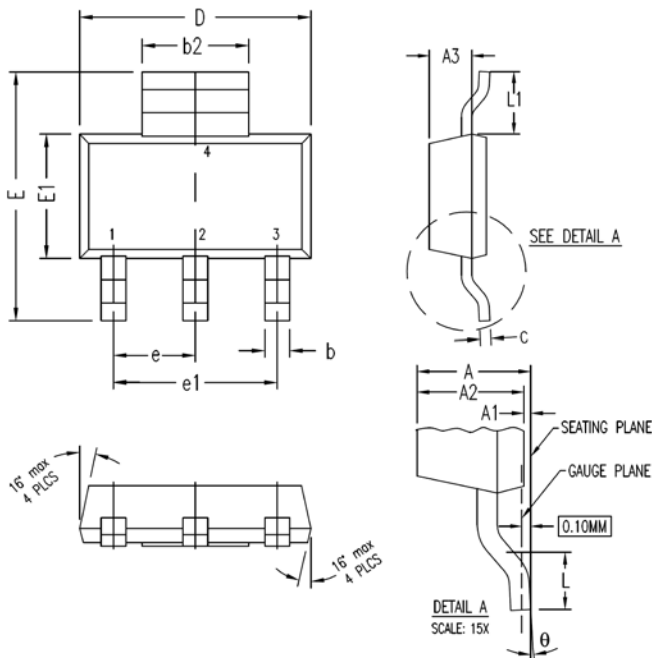

SYM	INCHES		MILLIMETERS	
	MIN	MAX	MIN	MAX
A	0.063	0.071	1.60	1.80
A1	0.001	0.005	0.02	0.13
A2	0.059	0.067	1.50	1.70
A3	0.043	0.051	1.10	1.30
b	0.026	0.033	0.66	0.84
b2	0.116	0.124	2.95	3.15
c	0.009	0.015	0.24	0.38
D	0.248	0.264	6.30	6.70
E	0.264	0.287	6.70	7.30
E1	0.130	0.146	3.30	3.70
e	0.087	0.094	2.20	2.40
e1	0.177	0.185	4.50	4.70
L	0.024	0.036	0.62	0.92
L1	0.065	0.073	1.65	1.85
θ	0°	10°	0°	10°



Disclaimer Notice - Information furnished is believed to be accurate and reliable. However, users should independently evaluate the suitability of and test each product selected for their own applications. Littelfuse products are not designed for, and may not be used in, all applications. Read complete Disclaimer Notice at www.littelfuse.com/disclaimer-electronics.