

# High Voltage Power MOSFET

## IXTT02N450HV IXTH02N450HV

$V_{DSS} = 4500V$   
 $I_{D25} = 200mA$   
 $R_{DS(on)} \leq 625\Omega$

N-Channel Enhancement Mode

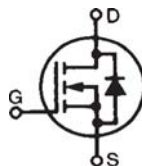

TO-268HV (IXTT)

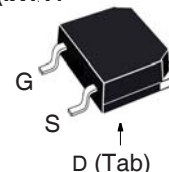

TO-247HV (IXTH)

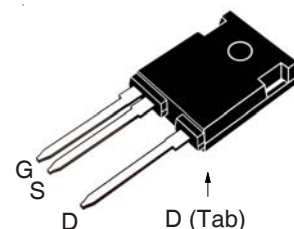

G = Gate      D = Drain  
 S = Source    Tab = Drain

Symbol	Test Conditions	Maximum Ratings	
$V_{DSS}$	$T_J = 25^\circ C$ to $150^\circ C$	4500	V
$V_{DGR}$	$T_J = 25^\circ C$ to $150^\circ C$ , $R_{GS} = 1M\Omega$	4500	V
$V_{GSS}$	Continuous	$\pm 20$	V
$V_{GSM}$	Transient	$\pm 30$	V
$I_{D25}$	$T_C = 25^\circ C$	200	mA
$I_{DM}$	$T_C = 25^\circ C$ , Pulse Width Limited by $T_{JM}$	600	mA
$P_D$	$T_C = 25^\circ C$	113	W
$T_J$		- 55 ... +150	$^\circ C$
$T_{JM}$		150	$^\circ C$
$T_{stg}$		- 55 ... +150	$^\circ C$
$T_L$	Maximum Lead Temperature for Soldering	300	$^\circ C$
$T_{SOLD}$	Plastic Body for 10s	260	$^\circ C$
$M_d$	Mounting Torque	1.13/10	Nm/lb.in
<b>Weight</b>	TO-268HV	4	g
	TO-247HV	6	g

### Features

- High Blocking Voltage
- High Voltage Packages

### Advantages

- Easy to Mount
- Space Savings
- High Power Density

### Applications

- High Voltage Power Supplies
- Capacitor Discharge Applications
- Pulse Circuits
- Laser and X-Ray Generation Systems

Symbol	Test Conditions ( $T_J = 25^\circ C$ , Unless Otherwise Specified)	Characteristic Values		
		Min.	Typ.	Max.
$V_{GS(th)}$	$V_{DS} = V_{GS}$ , $I_D = 250\mu A$	4.0		6.5 V
$I_{GSS}$	$V_{GS} = \pm 20V$ , $V_{DS} = 0V$			$\pm 100$ nA
$I_{DSS}$	$V_{DS} = 3.6kV$ , $V_{GS} = 0V$ $V_{DS} = 4.5kV$ $V_{DS} = 3.6kV$ $T_J = 125^\circ C$			5 $\mu A$
				10 $\mu A$
			15	$\mu A$
$R_{DS(on)}$	$V_{GS} = 10V$ , $I_D = 10mA$ , Note 1			625 $\Omega$

Symbol	Test Conditions ( $T_J = 25^\circ\text{C}$ , Unless Otherwise Specified)	Characteristic Values		
		Min.	Typ.	Max.
$g_{fs}$	$V_{DS} = 50\text{V}$ , $I_D = 50\text{mA}$ , Note 1	90	150	mS
$C_{iss}$	$V_{GS} = 0\text{V}$ , $V_{DS} = 25\text{V}$ , $f = 1\text{MHz}$		246	pF
$C_{oss}$			19	pF
$C_{rss}$			5.8	pF
$R_{Gi}$	Gate Input Resistance		76	$\Omega$
$t_{d(on)}$	<b>Resistive Switching Times</b> $V_{GS} = 10\text{V}$ , $V_{DS} = 500\text{V}$ , $I_D = 0.5 \cdot I_{D25}$ $R_G = 10\Omega$ (External)		17	ns
$t_r$			48	ns
$t_{d(off)}$			28	ns
$t_f$			143	ns
$Q_{g(on)}$	$V_{GS} = 10\text{V}$ , $V_{DS} = 1\text{kV}$ , $I_D = 0.5 \cdot I_{D25}$		10.6	nC
$Q_{gs}$			3.3	nC
$Q_{gd}$			5.5	nC
$R_{thJC}$				1.1 $^\circ\text{C/W}$
$R_{thCS}$	TO-247HV		0.21	$^\circ\text{C/W}$

### Source-Drain Diode

Symbol	Test Conditions ( $T_J = 25^\circ\text{C}$ , Unless Otherwise Specified)	Characteristic Values		
		Min.	Typ.	Max.
$I_s$	$V_{GS} = 0\text{V}$			200 mA
$I_{SM}$	Repetitive, Pulse Width Limited by $T_{JM}$			800 mA
$V_{SD}$	$I_F = I_s$ , $V_{GS} = 0\text{V}$ , Note 1			1.5 V
$t_{rr}$	$I_F = 200\text{mA}$ , $-di/dt = 50\text{A}/\mu\text{s}$ , $V_R = 100\text{V}$		1.6	$\mu\text{s}$

Note: 1. Pulse test,  $t \leq 300\mu\text{s}$ , duty cycle,  $d \leq 2\%$ .

IXYS Reserves the Right to Change Limits, Test Conditions, and Dimensions.

IXYS MOSFETs and IGBTs are covered by one or more of the following U.S. patents:

4,835,592	4,931,844	5,049,961	5,237,481	6,162,665	6,404,065 B1	6,683,344	6,727,585	7,005,734 B2	7,157,338B2
4,860,072	5,017,508	5,063,307	5,381,025	6,259,123 B1	6,534,343	6,710,405 B2	6,759,692	7,063,975 B2	
4,881,106	5,034,796	5,187,117	5,486,715	6,306,728 B1	6,583,505	6,710,463	6,771,478 B2	7,071,537	

### TO-268HV Outline

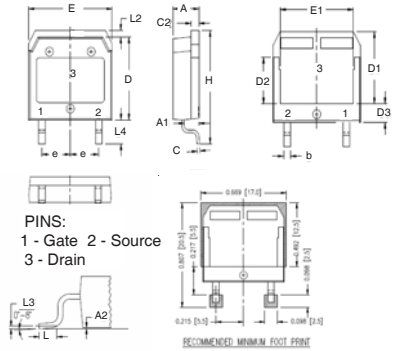

SYM	INCHES		MILLIMETER	
	MIN	MAX	MIN	MAX
A	.193	.201	4.90	5.10
A1	.106	.114	2.70	2.90
A2	.001	.010	0.02	0.25
b	.045	.057	1.15	1.45
C	.016	.026	0.40	0.65
C2	.057	.063	1.45	1.60
D	.543	.551	13.80	14.00
D1	.465	.476	11.80	12.10
D2	.295	.307	7.50	7.80
D3	.114	.126	2.90	3.20
E	.624	.632	15.85	16.05
E1	.524	.535	13.30	13.60
E	.215	BSC	5.45	BSC
H	.736	.752	18.70	19.10
L	.067	.079	1.70	2.00
L2	.039	.045	1.00	1.15
L3	.010	BSC	0.25	BSC
L4	.150	.161	3.80	4.10

### TO-247HV Outline

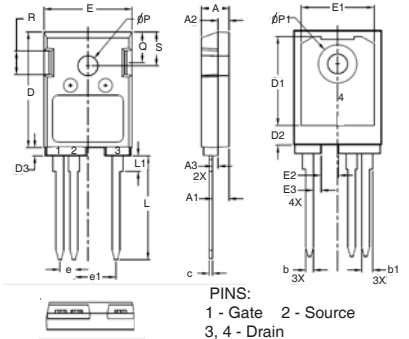

SYM	INCHES		MILLIMETERS	
	MIN	MAX	MIN	MAX
A	.193	.201	4.90	5.10
A1	.114	.122	2.90	3.10
A2	.075	.083	1.90	2.10
A3	.035	.043	0.90	1.10
b	.053	.059	1.35	1.50
b1	.075	.083	1.90	2.10
c	.022	.030	0.55	0.75
D	.819	.843	20.80	21.40
D1	.638	.646	16.20	16.40
D2	.134	.146	3.40	3.70
D3	.055	.063	1.40	1.60
E	.622	.638	15.80	16.20
E1	.520	.528	13.20	13.40
E2	.118	.126	3.00	3.20
E3	.051	.059	1.30	1.50
e	.100	BSC	2.54	BSC
e1	.300	BSC	7.62	BSC
L	.732	.748	18.60	19.00
L1	.106	.118	2.70	3.00
ØP	.138	.142	3.50	3.60
ØP1	.272	.280	6.90	7.10
Q	.216	.224	5.50	5.70
R	.165	.169	4.20	4.30
S	.240	.248	6.10	6.30

Fig. 1. Output Characteristics @  $T_J = 25^\circ\text{C}$

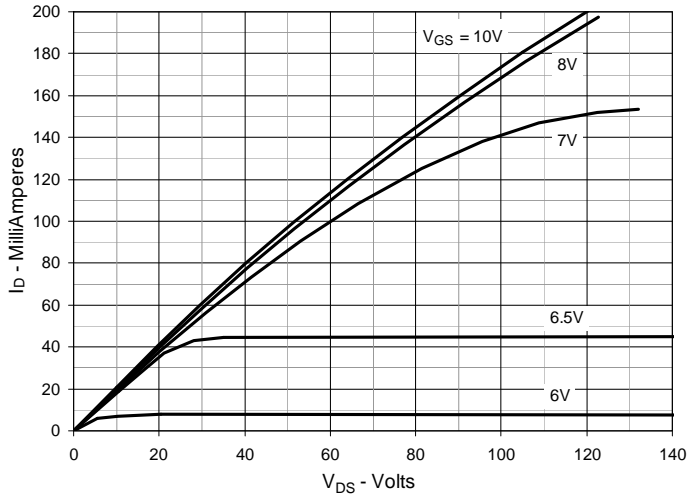

Fig. 2. Extended Output Characteristics @  $T_J = 25^\circ\text{C}$

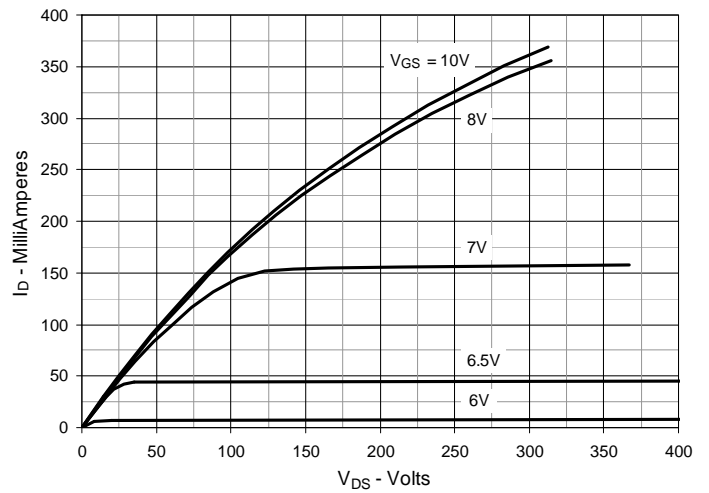

Fig. 3. Output Characteristics @  $T_J = 125^\circ\text{C}$

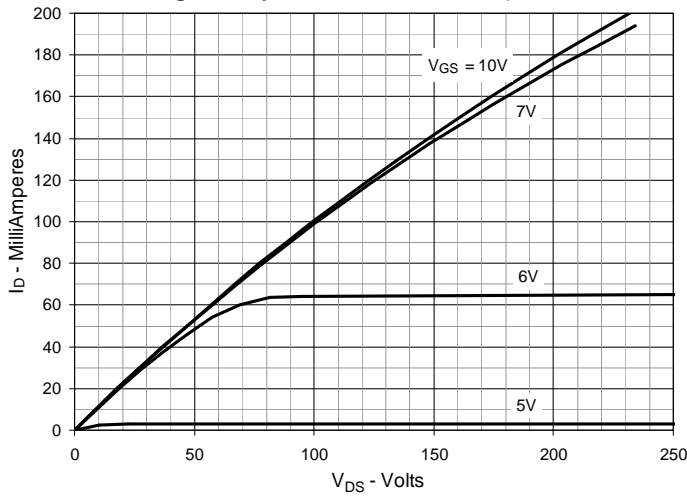

Fig. 4.  $R_{DS(on)}$  Normalized to  $I_D = 100\text{mA}$  Value vs. Junction Temperature

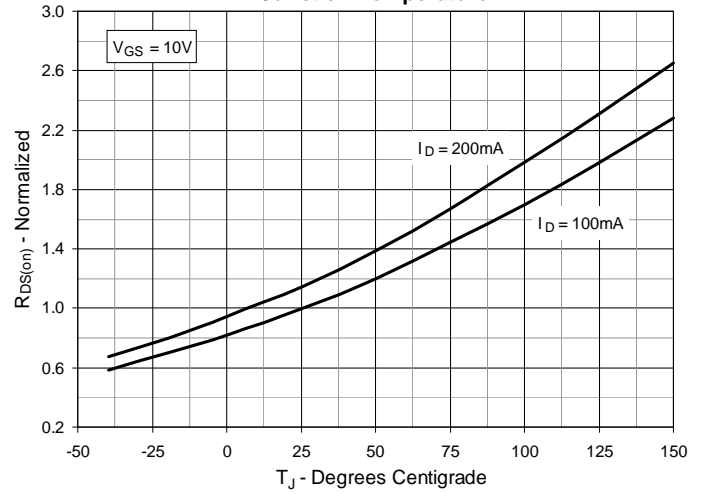

Fig. 5.  $R_{DS(on)}$  Normalized to  $I_D = 100\text{mA}$  Value vs. Drain Current

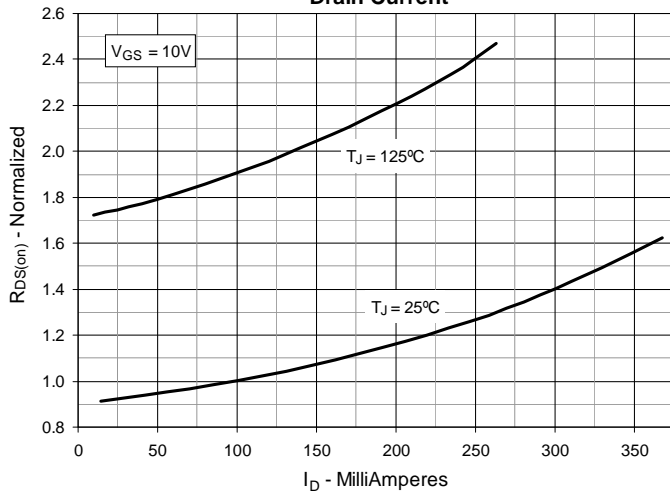
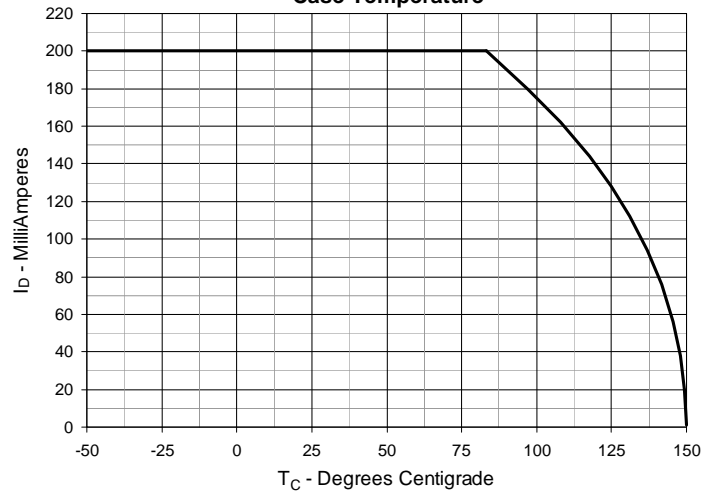
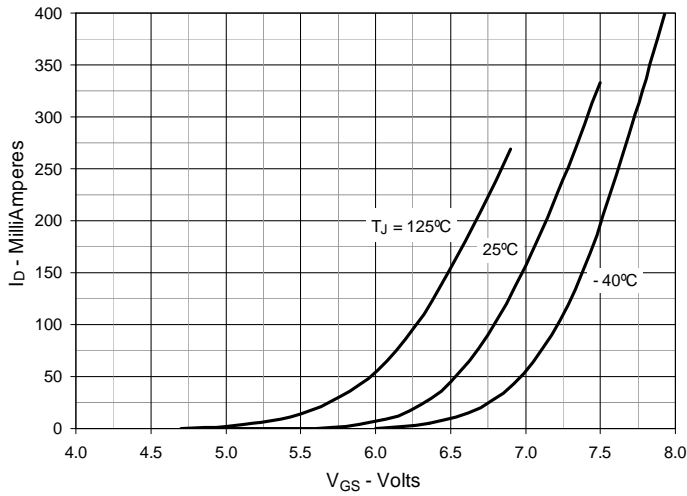

Fig. 6. Maximum Drain Current vs. Case Temperature



**Fig. 7. Input Admittance**



**Fig. 8. Transconductance**

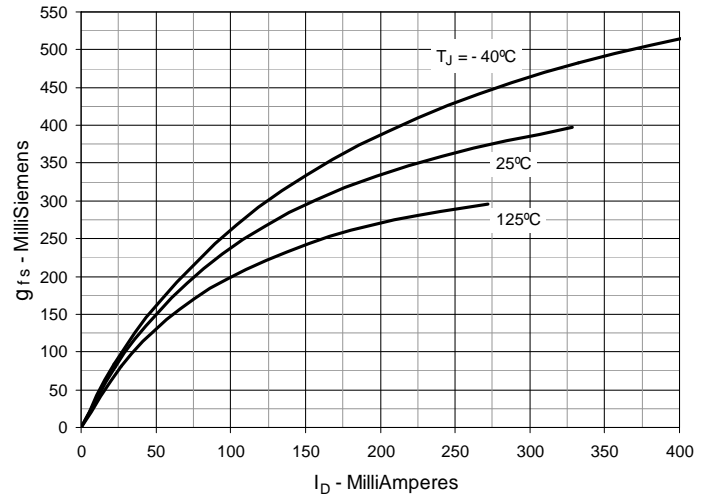

**Fig. 9. Forward Voltage Drop of Intrinsic Diode**

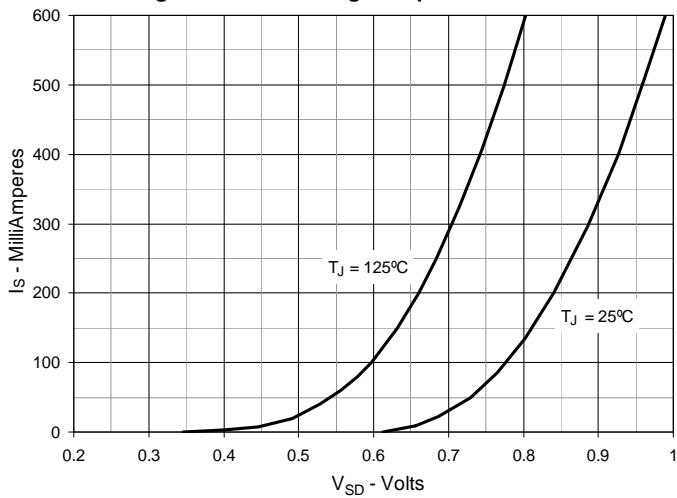

**Fig. 10. Gate Charge**

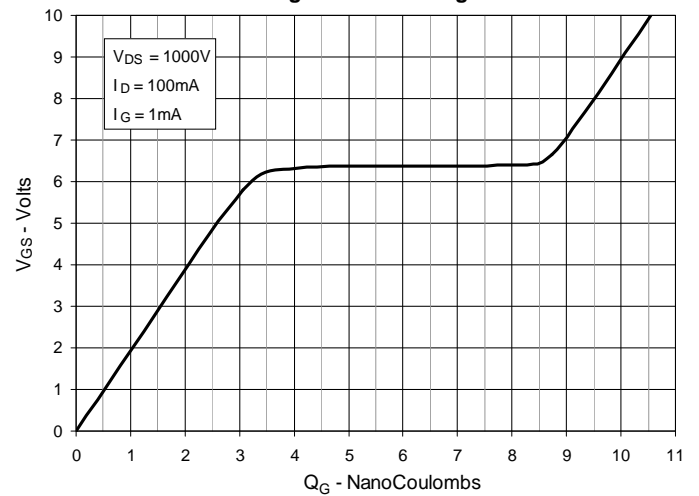

**Fig. 11. Capacitance**

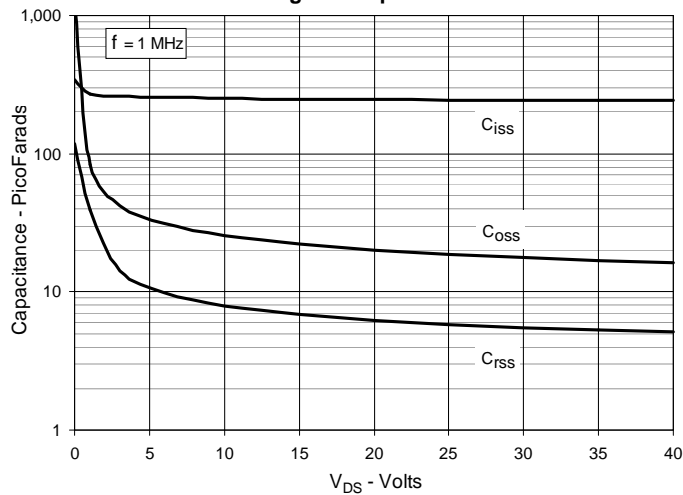

**Fig. 12. Maximum Transient Thermal Impedance**

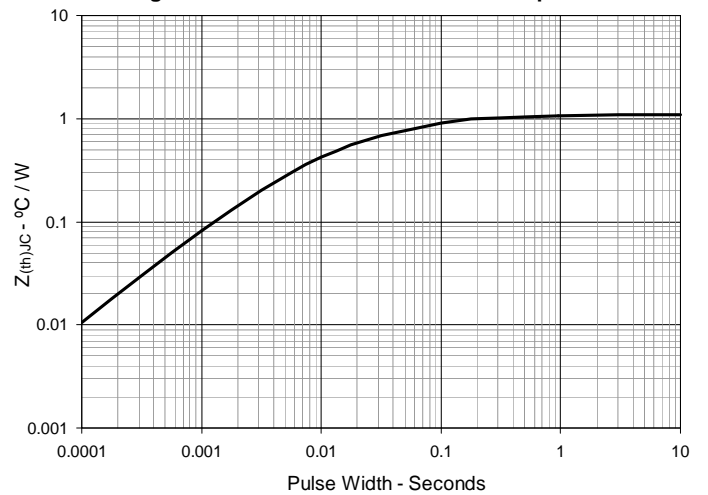

**Fig. 13. Forward-Bias Safe Operating Area  
@  $T_C = 25^\circ\text{C}$**

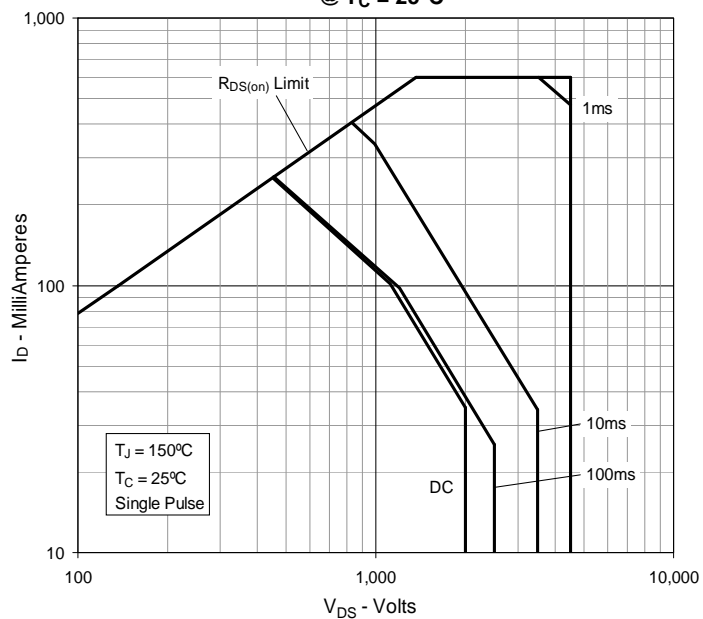

**Fig. 14. Forward-Bias Safe Operating Area  
@  $T_C = 75^\circ\text{C}$**

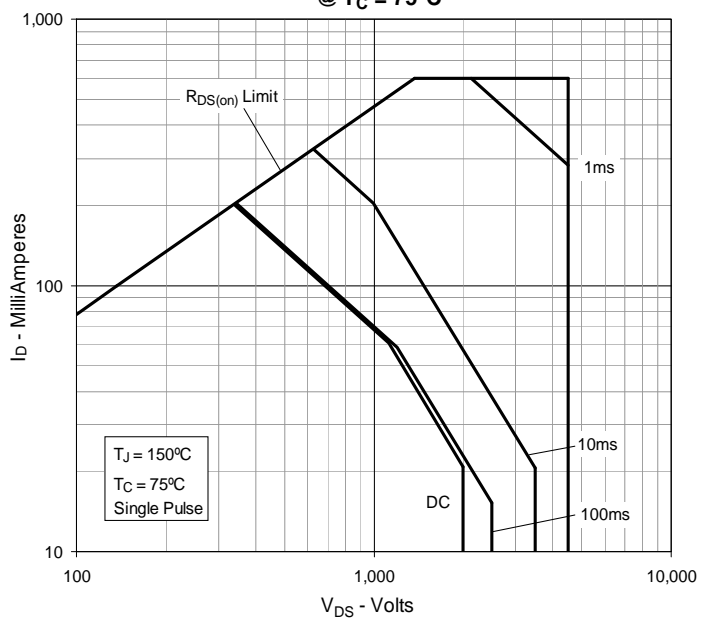



---

Disclaimer Notice - Information furnished is believed to be accurate and reliable. However, users should independently evaluate the suitability of and test each product selected for their own applications. Littelfuse products are not designed for, and may not be used in, all applications. Read complete Disclaimer Notice at [www.littelfuse.com/disclaimer-electronics](http://www.littelfuse.com/disclaimer-electronics).