

PolarHT™ Power MOSFET

IXTQ 140N10P
IXTT 140N10P

$V_{DSS} = 100 \text{ V}$
 $I_{D25} = 140 \text{ A}$
 $R_{DS(on)} \leq 11 \text{ m}\Omega$

N-Channel Enhancement Mode
Avalanche Rated



| Symbol | Test Conditions | Maximum Ratings | |
|--------------|---|-----------------|------------------|
| V_{DSS} | $T_J = 25^\circ\text{C to } 175^\circ\text{C}$ | 100 | V |
| V_{DGR} | $T_J = 25^\circ\text{C to } 175^\circ\text{C}; R_{GS} = 1 \text{ M}\Omega$ | 100 | V |
| V_{GS} | Continuous | ± 20 | V |
| V_{GSM} | Transient | ± 30 | V |
| I_{D25} | $T_C = 25^\circ\text{C}$ | 140 | A |
| $I_{D(RMS)}$ | External lead current limit | 75 | A |
| I_{DM} | $T_C = 25^\circ\text{C}$, pulse width limited by T_{JM} | 300 | A |
| I_{AR} | $T_C = 25^\circ\text{C}$ | 60 | A |
| E_{AR} | $T_C = 25^\circ\text{C}$ | 80 | mJ |
| E_{AS} | $T_C = 25^\circ\text{C}$ | 2.5 | J |
| dv/dt | $I_S \leq I_{DM}$, $di/dt \leq 100 \text{ A}/\mu\text{s}$, $V_{DD} \leq V_{DSS}$, $T_J \leq 150^\circ\text{C}$, $R_G = 4 \Omega$ | 10 | V/ns |
| P_D | $T_C = 25^\circ\text{C}$ | 600 | W |
| T_J | | -55 ... +175 | $^\circ\text{C}$ |
| T_{JM} | | 175 | $^\circ\text{C}$ |
| T_{stg} | | -55 ... +150 | $^\circ\text{C}$ |
| T_L | 1.6 mm (0.062 in.) from case for 10 s | 300 | $^\circ\text{C}$ |
| T_{SOLD} | Plastic body for 10 s | 260 | $^\circ\text{C}$ |
| M_d | Mounting torque (TO-3P) | 1.13/10 | Nm/lb.in. |
| Weight | TO-3P | 5.5 | g |
| | TO-268 | 5.0 | g |

TO-3P (IXTQ)



TO-268 (IXTT)

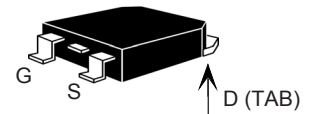

G = Gate D = Drain
S = Source TAB = Drain

Features

- † International standard packages
- † Unclamped Inductive Switching (UIS) rated
- † Low package inductance
- easy to drive and to protect

Advantages

- † Easy to mount
- † Space savings
- † High power density

| Symbol | Test Conditions | Characteristic Values | | |
|--------------|---|-----------------------|------|-----------------------------------|
| | | Min. | Typ. | Max. |
| BV_{DSS} | $V_{GS} = 0 \text{ V}$, $I_D = 250 \mu\text{A}$ | 100 | | V |
| $V_{GS(th)}$ | $V_{DS} = V_{GS}$, $I_D = 250 \mu\text{A}$ | 3.0 | | 5.0 V |
| I_{GSS} | $V_{GS} = \pm 20 \text{ V}_{DC}$, $V_{DS} = 0$ | | | $\pm 100 \text{ nA}$ |
| I_{DSS} | $V_{DS} = V_{DSS}$ $V_{GS} = 0 \text{ V}$ $T_J = 175^\circ\text{C}$ | | | 25 μA |
| | | | | 500 μA |
| $R_{DS(on)}$ | $V_{GS} = 10 \text{ V}$, $I_D = 0.5 I_{D25}$ $V_{GS} = 15 \text{ V}$, $I_D = 300 \text{ A}$ Pulse test, $t \leq 300 \mu\text{s}$, duty cycle $d \leq 2 \%$ | 9 | | 11 $\text{m}\Omega$ m Ω |

| Symbol | Test Conditions | Characteristic Values ($T_J = 25^\circ\text{C}$, unless otherwise specified) | | |
|--------------|---|---|------|------------------------|
| | | Min. | Typ. | Max. |
| g_{fs} | $V_{DS} = 10\text{ V}$; $I_D = 0.5 I_{D25}$, pulse test | 45 | 65 | S |
| C_{iss} | $V_{GS} = 0\text{ V}$, $V_{DS} = 25\text{ V}$, $f = 1\text{ MHz}$ | | 4700 | pF |
| C_{oss} | | | 1850 | pF |
| C_{rss} | | | 600 | pF |
| $t_{d(on)}$ | $V_{GS} = 10\text{ V}$, $V_{DS} = 0.5 V_{DSS}$, $I_D = 60\text{ A}$ $R_G = 4\ \Omega$ (External) | | 35 | ns |
| t_r | | | 50 | ns |
| $t_{d(off)}$ | | | 85 | ns |
| t_f | | | 26 | ns |
| $Q_{g(on)}$ | $V_{GS} = 10\text{ V}$, $V_{DS} = 0.5 V_{DSS}$, $I_D = 0.5 I_{D25}$ | | 155 | nC |
| Q_{gs} | | | 33 | nC |
| Q_{gd} | | | 85 | nC |
| R_{thJC} | (TO-3P) | | | 0.25°C/W |
| R_{thCS} | | 0.21 | | $^\circ\text{C/W}$ |

| Symbol | Test Conditions | Characteristic Values ($T_J = 25^\circ\text{C}$, unless otherwise specified) | | |
|----------|--|---|------|---------------|
| | | Min. | Typ. | Max. |
| I_s | $V_{GS} = 0\text{ V}$ | | | 140 A |
| I_{SM} | Repetitive | | | 300 A |
| V_{SD} | $I_F = I_s$, $V_{GS} = 0\text{ V}$, Pulse test, $t \leq 300\ \mu\text{s}$, duty cycle $d \leq 2\%$ | | | 1.5 V |
| t_{rr} | $I_F = 25\text{ A}$, $-di/dt = 100\text{ A}/\mu\text{s}$ $V_R = 50\text{ V}$, $V_{GS} = 0\text{ V}$ | | 120 | ns |
| Q_{RM} | | | 2.0 | μC |

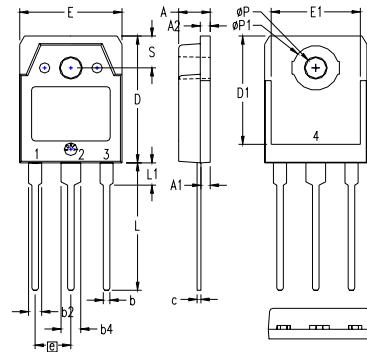
TO-3P (IXTQ) Outline

- 1 - GATE
- 2 - DRAIN (COLLECTOR)
- 3 - SOURCE (EMITTER)
- 4 - DRAIN (COLLECTOR)

| SYM | INCHES | | MILLIMETERS | |
|--------|----------|------|-------------|-------|
| | MIN | MAX | MIN | MAX |
| A | .185 | .193 | 4.70 | 4.90 |
| A1 | .051 | .059 | 1.30 | 1.50 |
| A2 | .057 | .065 | 1.45 | 1.65 |
| b | .035 | .045 | 0.90 | 1.15 |
| b2 | .075 | .087 | 1.90 | 2.20 |
| b4 | .114 | .126 | 2.90 | 3.20 |
| c | .022 | .031 | 0.55 | 0.80 |
| D | .780 | .799 | 19.80 | 20.30 |
| D1 | .665 | .677 | 16.90 | 17.20 |
| E | .610 | .622 | 15.50 | 15.80 |
| E1 | .531 | .539 | 13.50 | 13.70 |
| e | .215 BSC | | 5.45 BSC | |
| L | .779 | .795 | 19.80 | 20.20 |
| L1 | .134 | .142 | 3.40 | 3.60 |
| phi P1 | .126 | .134 | 3.20 | 3.40 |
| S | .272 | .280 | 6.90 | 7.10 |
| S | .193 | .201 | 4.90 | 5.10 |

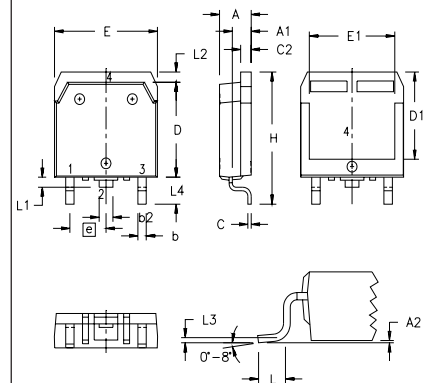
TO-268 (IXTT) Outline

| SYM | INCHES | | MILLIMETERS | |
|-----|----------|------|-------------|-------|
| | MIN | MAX | MIN | MAX |
| A | .193 | .201 | 4.90 | 5.10 |
| A1 | .106 | .114 | 2.70 | 2.90 |
| A2 | .001 | .010 | 0.02 | 0.25 |
| b | .045 | .057 | 1.15 | 1.45 |
| b2 | .075 | .083 | 1.90 | 2.10 |
| C | .016 | .026 | 0.40 | 0.65 |
| C2 | .057 | .063 | 1.45 | 1.60 |
| D | .543 | .551 | 13.80 | 14.00 |
| D1 | .488 | .500 | 12.40 | 12.70 |
| E | .624 | .632 | 15.85 | 16.05 |
| E1 | .524 | .535 | 13.30 | 13.60 |
| e | .215 BSC | | 5.45 BSC | |
| H | .736 | .752 | 18.70 | 19.10 |
| L | .094 | .106 | 2.40 | 2.70 |
| L1 | .047 | .055 | 1.20 | 1.40 |
| L2 | .039 | .045 | 1.00 | 1.15 |
| L3 | .010 BSC | | 0.25 BSC | |
| L4 | .150 | .161 | 3.80 | 4.10 |

IXYS reserves the right to change limits, test conditions, and dimensions.

| | | | | | | | | |
|--|-----------|-----------|-----------|-----------|--------------|--------------|--------------|--------------|
| IXYS MOSFETs and IGBTs are covered by | 4,835,592 | 4,931,844 | 5,049,961 | 5,237,481 | 6,162,665 | 6,404,065 B1 | 6,683,344 | 6,727,585 |
| one or more of the following U.S. patents: | 4,850,072 | 5,017,508 | 5,063,307 | 5,381,025 | 6,259,123 B1 | 6,534,343 | 6,710,405 B2 | 6,759,692 |
| | 4,881,106 | 5,034,796 | 5,187,117 | 5,486,715 | 6,306,728 B1 | 6,583,505 | 6,710,463 | 6,771,478 B2 |

Fig. 1. Output Characteristics
@ 25°C

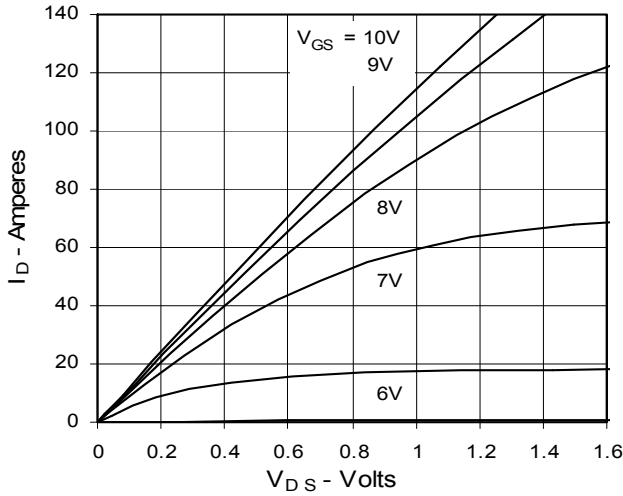

Fig. 2. Extended Output Characteristics
@ 25°C

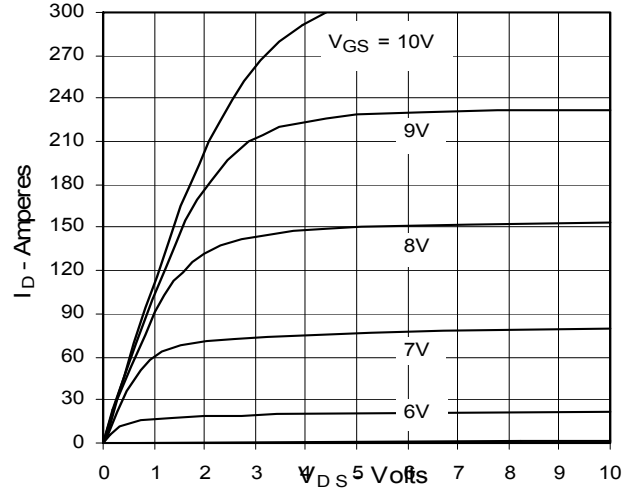

Fig. 3. Output Characteristics
@ 150°C

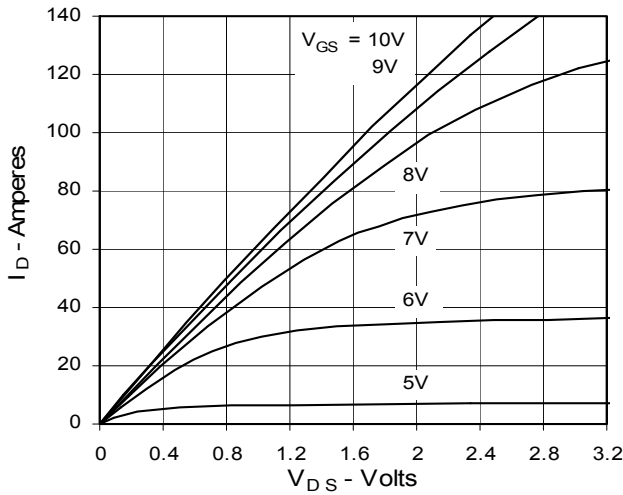

Fig. 4. $R_{DS(on)}$ Normalized to 0.5 I_{D25} Value vs. Junction Temperature

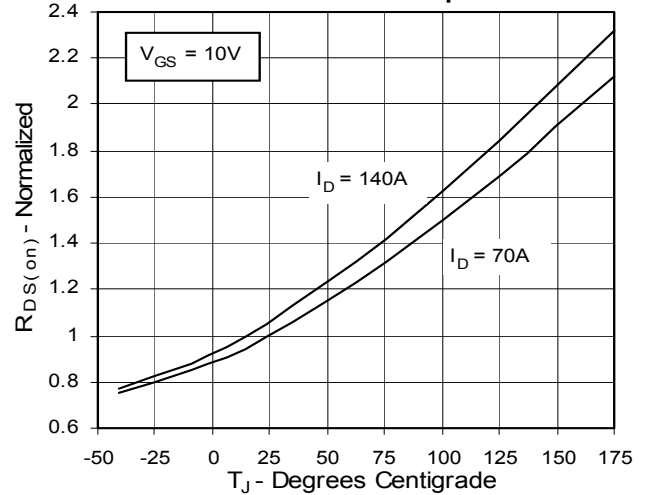

Fig. 5. $R_{DS(on)}$ Normalized to 0.5 I_{D25} Value vs. Drain Current

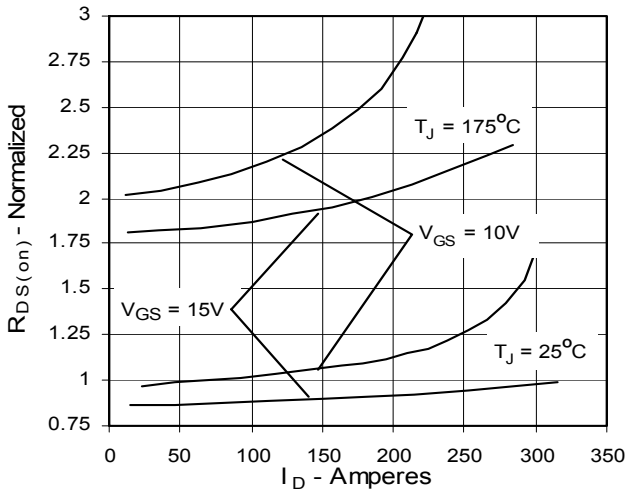

Fig. 6. Drain Current vs. Case Temperature

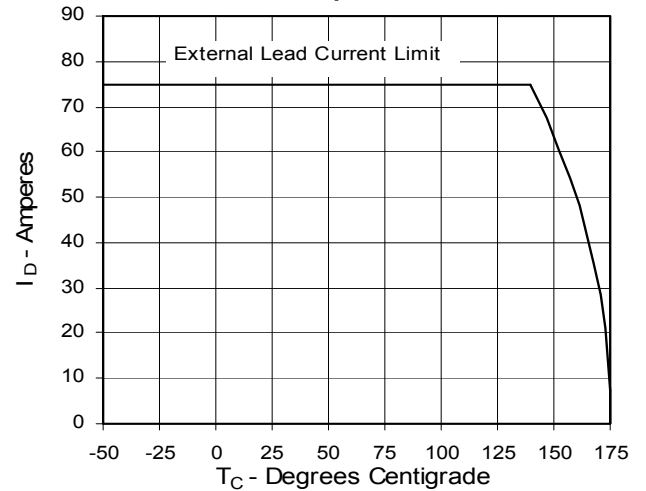

Fig. 7. Input Admittance

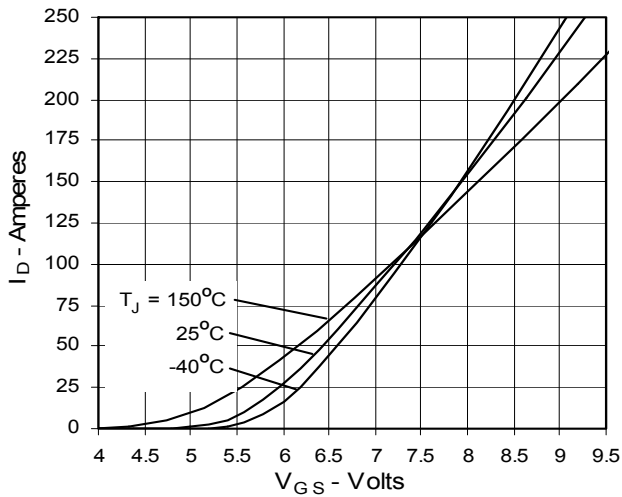

Fig. 8. Transconductance

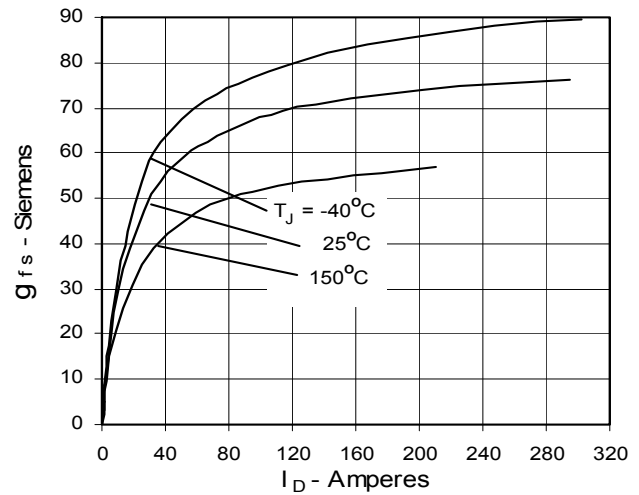

Fig. 9. Source Current vs. Source-To-Drain Voltage

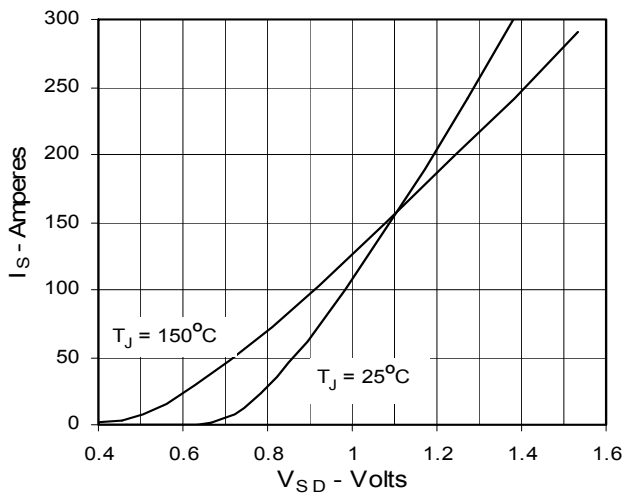

Fig. 10. Gate Charge

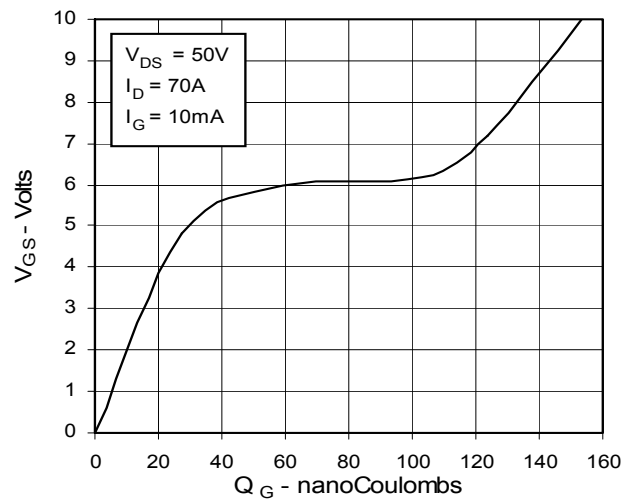

Fig. 11. Capacitance

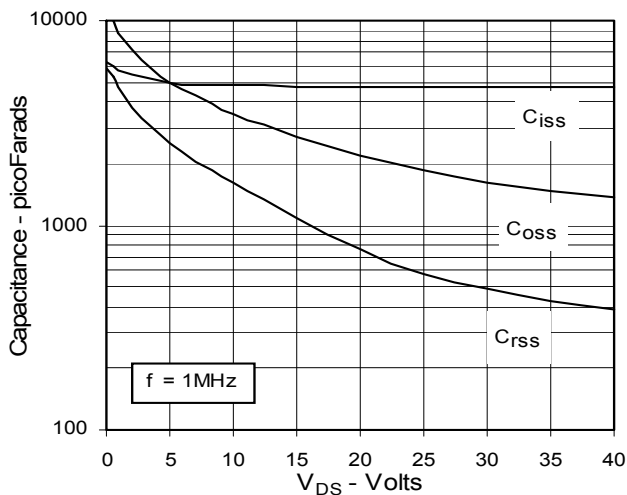

Fig. 12. Forward-Bias Safe Operating Area

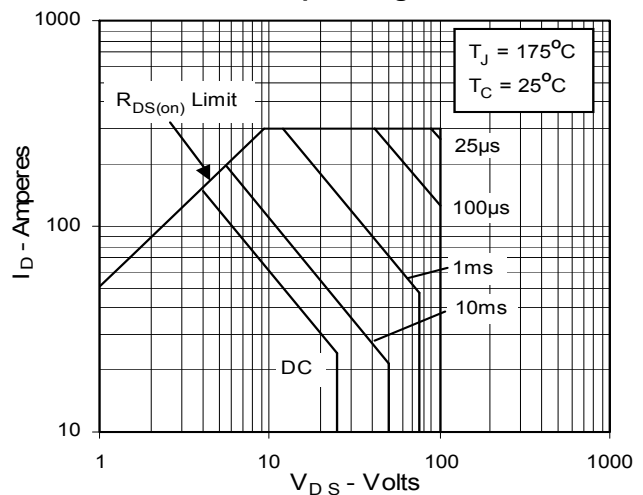
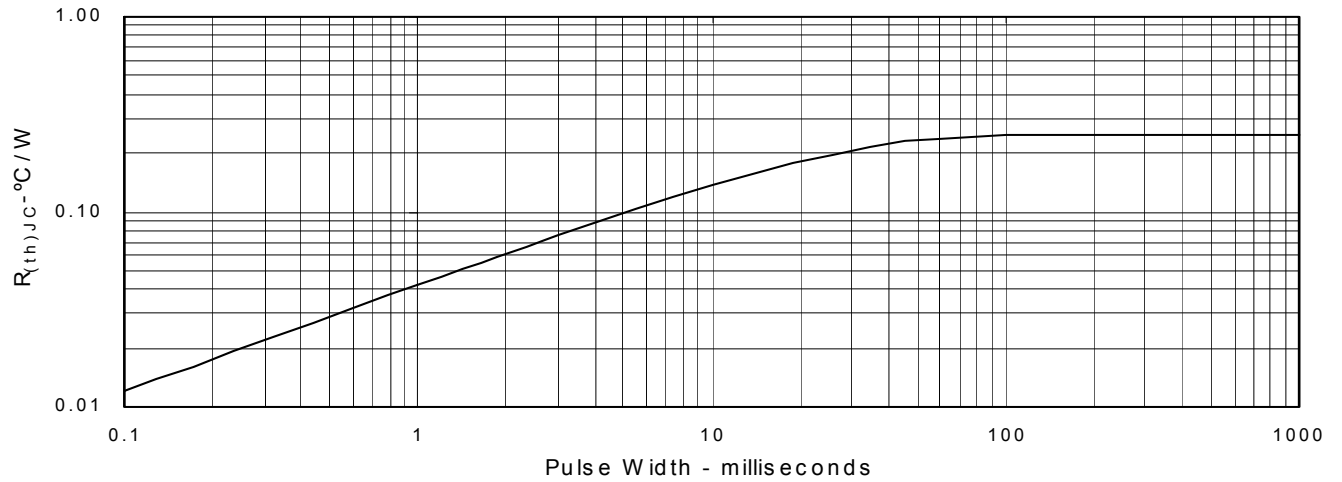

Fig. 13. Maximum Transient Thermal Resistance





Disclaimer Notice - Information furnished is believed to be accurate and reliable. However, users should independently evaluate the suitability of and test each product selected for their own applications. Littelfuse products are not designed for, and may not be used in, all applications. Read complete Disclaimer Notice at www.littelfuse.com/disclaimer-electronics.