

## PolarHV™ Power MOSFET

N-Channel Enhancement Mode  
Avalanche Rated

**IXTH 36N50P**  
**IXTQ 36N50P**  
**IXTT 36N50P**  
**IXTV 36N50P**  
**IXTV 36N50PS**

$V_{DSS} = 500 \text{ V}$   
 $I_{D25} = 36 \text{ A}$   
 $R_{DS(on)} \leq 170 \text{ m}\Omega$

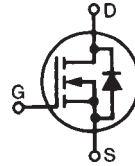

Symbol	Test Conditions	Maximum Ratings	
$V_{DSS}$	$T_J = 25^\circ\text{C to } 150^\circ\text{C}$	500	V
$V_{DGR}$	$T_J = 25^\circ\text{C to } 150^\circ\text{C}; R_{GS} = 1 \text{ M}\Omega$	500	V
$V_{GS}$	Continuous	$\pm 30$	V
$V_{GSM}$	Transient	$\pm 40$	V
$I_{D25}$	$T_C = 25^\circ\text{C}$	36	A
$I_{DM}$	$T_C = 25^\circ\text{C}$ , pulse width limited by $T_{JM}$	108	A
$I_{AR}$	$T_C = 25^\circ\text{C}$	36	A
$E_{AR}$	$T_C = 25^\circ\text{C}$	50	mJ
$E_{AS}$	$T_C = 25^\circ\text{C}$	1.5	J
$dv/dt$	$I_S \leq I_{DM}$ , $di/dt \leq 100 \text{ A}/\mu\text{s}$ , $V_{DD} \leq V_{DSS}$ , $T_J \leq 150^\circ\text{C}$ , $R_G = 3 \Omega$	10	V/ns
$P_D$	$T_C = 25^\circ\text{C}$	540	W
$T_J$		-55 ... +150	$^\circ\text{C}$
$T_{JM}$		150	$^\circ\text{C}$
$T_{stg}$		-55 ... +150	$^\circ\text{C}$
$T_L$	1.6 mm (0.062 in.) from case for 10 s	300	$^\circ\text{C}$
$T_{SOLD}$	Plastic body for 10 s	260	$^\circ\text{C}$
$M_d$	Mounting torque(TO-247)	1.13/10	Nm/lb.in.
$F_c$	Mounting force (PLUS220)	20..120/4.5..15	N/lb
Weight	TO-247	6	g
	TO-268	5	g
	PLUS220	2	g
	TO-3P	5.5	g

TO-3P (IXTQ)

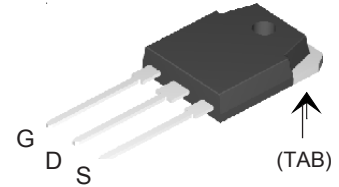

TO-247 (IXTH)

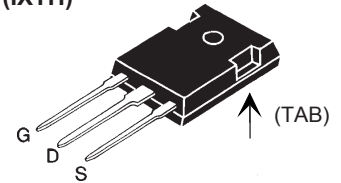

TO-268 (IXTT)

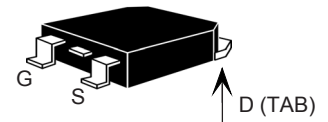

PLUS220 (IXTV)

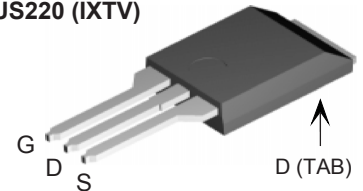

PLUS220 SMD(IXTV..S)

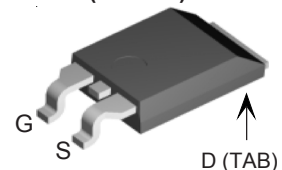

G = Gate  
S = Source  
D = Drain  
TAB = Drain

Symbol	Test Conditions ( $T_J = 25^\circ\text{C}$ unless otherwise specified)	Characteristic Values		
		Min.	Typ.	Max.
$V_{DSS}$	$V_{GS} = 0 \text{ V}$ , $I_D = 250 \mu\text{A}$	500		V
$V_{GS(th)}$	$V_{DS} = V_{GS}$ , $I_D = 250 \mu\text{A}$	3.0		5.0 V
$I_{GSS}$	$V_{GS} = \pm 30 \text{ V}_{DC}$ , $V_{DS} = 0$			$\pm 100 \text{ nA}$
$I_{DSS}$	$V_{DS} = V_{DSS}$ $V_{GS} = 0 \text{ V}$ $T_J = 125^\circ\text{C}$			25 $\mu\text{A}$
				250 $\mu\text{A}$
$R_{DS(on)}$	$V_{GS} = 10 \text{ V}$ , $I_D = 0.5 I_{D25}$ Pulse test, $t \leq 300 \mu\text{s}$ , duty cycle $d \leq 2 \%$			170 m $\Omega$

### Features

- International standard packages
- Unclamped Inductive Switching (UIS) rated
- Low package inductance
- easy to drive and to protect

Symbol	Test Conditions	Characteristic Values ( $T_J = 25^\circ\text{C}$ unless otherwise specified)		
		Min.	Typ.	Max.
$g_{fs}$	$V_{DS} = 20\text{ V}; I_D = 0.5 I_{D25}$ , pulse test	23	36	S
$C_{iss}$	$V_{GS} = 0\text{ V}, V_{DS} = 25\text{ V}, f = 1\text{ MHz}$		5500	pF
$C_{oss}$			510	pF
$C_{rss}$			40	pF
$t_{d(on)}$	$V_{GS} = 10\text{ V}, V_{DS} = 0.5 V_{DSS}, I_D = I_{D25}$ $R_G = 3\ \Omega$ (External)		25	ns
$t_r$			27	ns
$t_{d(off)}$			75	ns
$t_f$			21	ns
$Q_{g(on)}$	$V_{GS} = 10\text{ V}, V_{DS} = 0.5 V_{DSS}, I_D = 0.5 I_{D25}$		85	nC
$Q_{gs}$			30	nC
$Q_{gd}$			31	nC
$R_{thJC}$				0.23 $^\circ\text{C/W}$
$R_{thCS}$	(TO-247 and TO-3P) (PLUS220)		0.21	$^\circ\text{C/W}$

**Source-Drain Diode**

Symbol	Test Conditions	Characteristic Values ( $T_J = 25^\circ\text{C}$ unless otherwise specified)		
		Min.	Typ.	Max.
$I_S$	$V_{GS} = 0\text{ V}$			36 A
$I_{SM}$	Repetitive			108 A
$V_{SD}$	$I_F = I_S, V_{GS} = 0\text{ V}$ , Pulse test, $t \leq 300\ \mu\text{s}$ , duty cycle $d \leq 2\%$			1.5 V
$t_{rr}$	$I_F = 25\text{ A}, -di/dt = 100\text{ A}/\mu\text{s}$ $V_R = 100\text{ V}, V_{GS} = 0\text{ V}$		400	ns

**Characteristic Curves**

**Fig. 1. Output Characteristics  
@ 25°C**

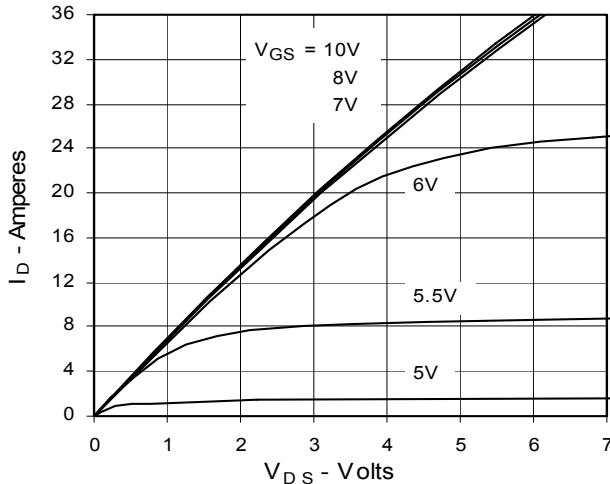

**Fig. 2. Extended Output Characteristics  
@ 25°C**

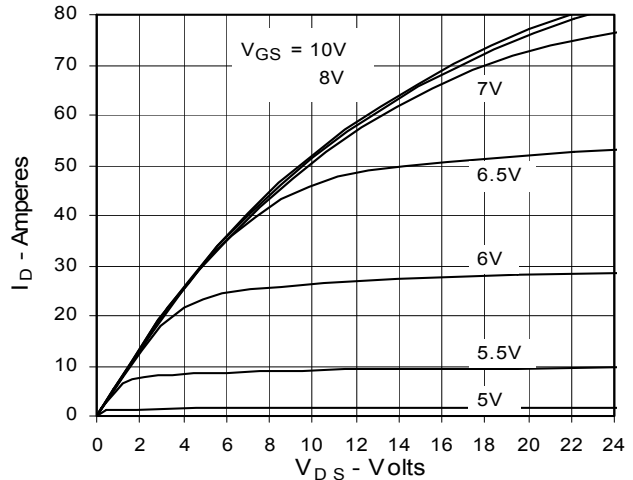

IXYS reserves the right to change limits, test conditions, and dimensions.

IXYS MOSFETs and IGBTs are covered by 4,835,592 4,931,844 5,049,961 5,237,481 6,162,665 6,404,065 B1 6,683,344 6,727,585  
one or more of the following U.S. patents: 4,850,072 5,017,508 5,063,307 5,381,025 6,259,123 B1 6,534,343 6,710,405B2 6,759,692  
4,881,106 5,034,796 5,187,117 5,486,715 6,306,728 B1 6,583,505 6,710,463 6,771,478 B2

**Fig. 3. Output Characteristics  
@ 125°C**

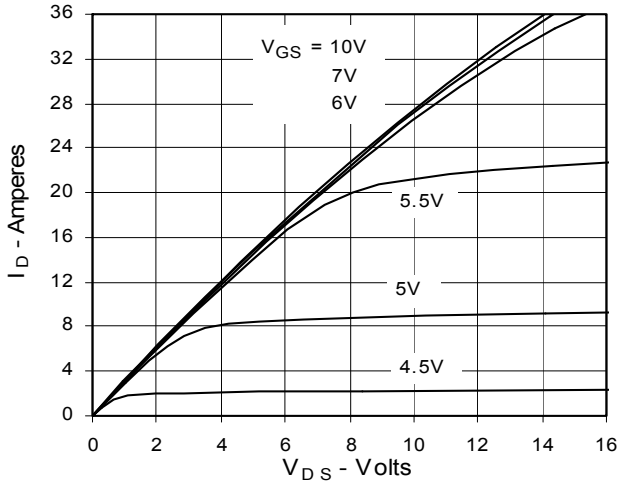

**Fig. 4.  $R_{DS(on)}$  Normalized to  $I_D = 18A$   
Value vs. Junction Temperature**

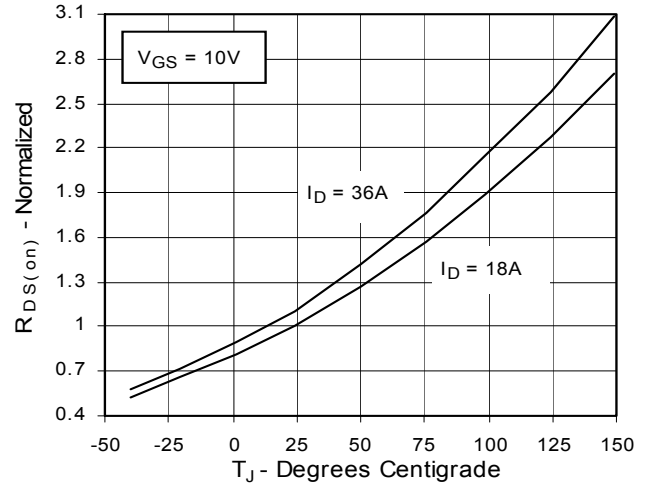

**Fig. 5.  $R_{DS(on)}$  Normalized to  
 $I_D = 18A$  Value vs. Drain Current**

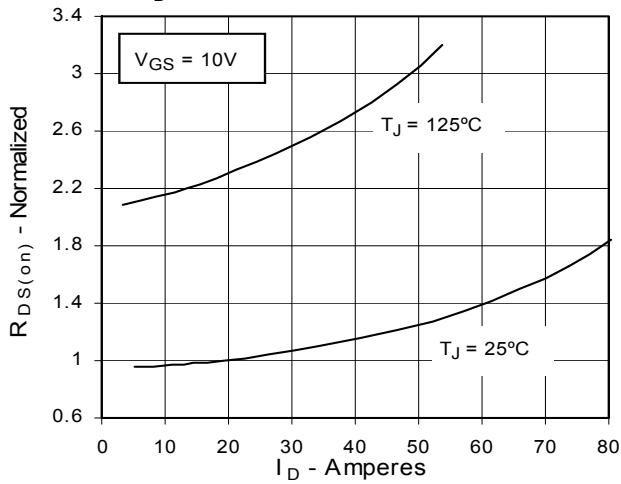

**Fig. 6. Drain Current vs. Case  
Temperature**

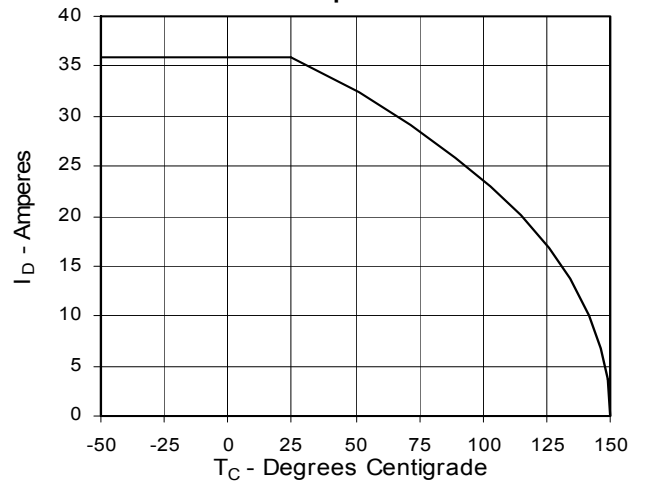

**Fig. 7. Input Admittance**

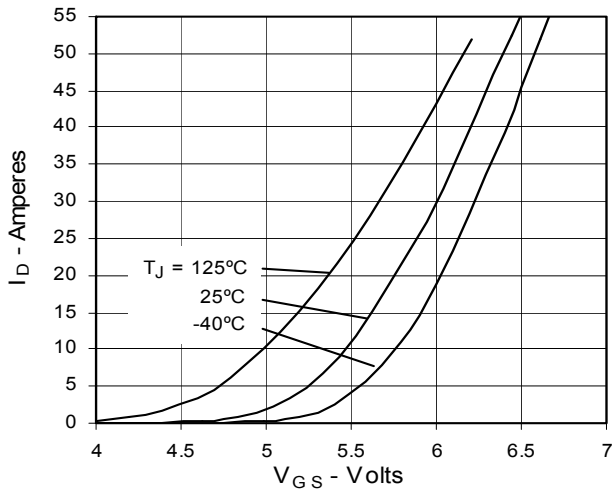

**Fig. 8. Transconductance**

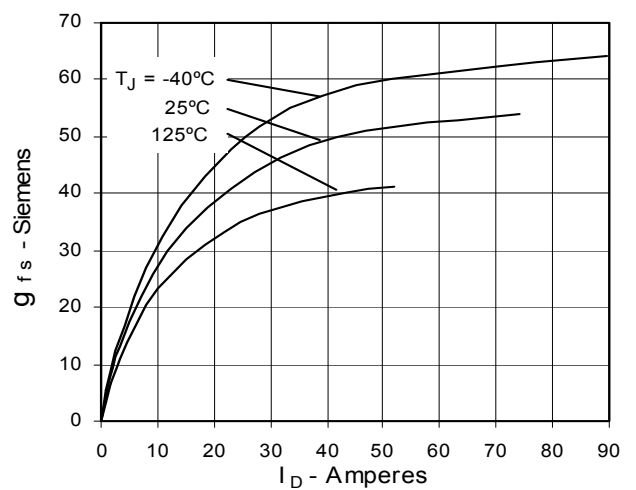

**Fig. 9. Source Current vs. Source-To-Drain Voltage**

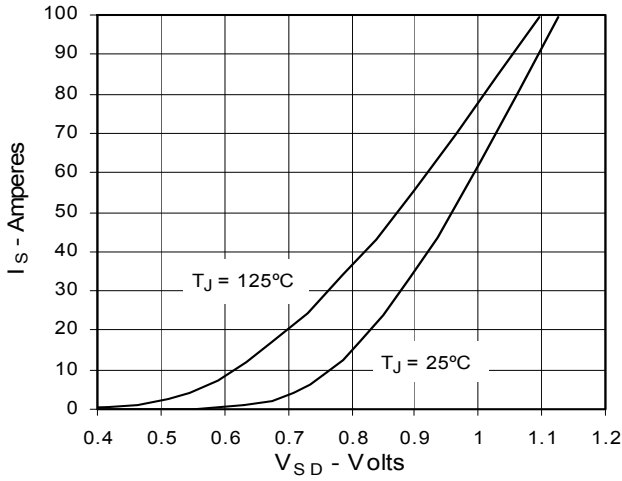

**Fig. 10. Gate Charge**

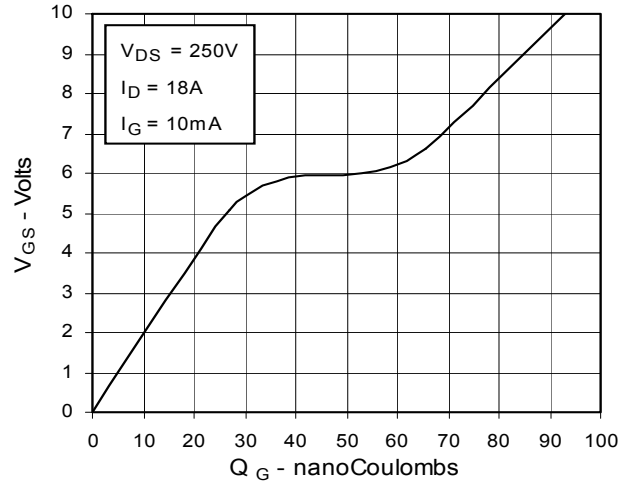

**Fig. 11. Capacitance**

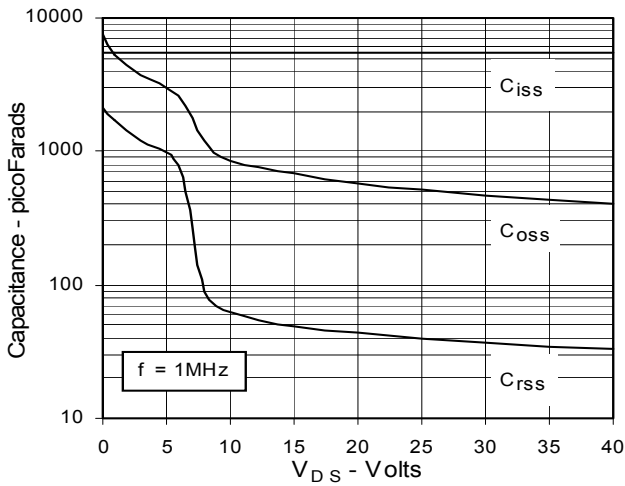

**Fig. 12. Forward-Bias Safe Operating Area**

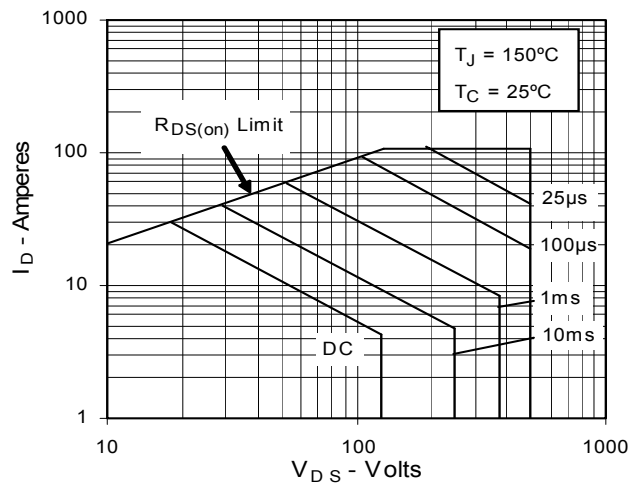

**Fig. 13. Maximum Transient Thermal Resistance**

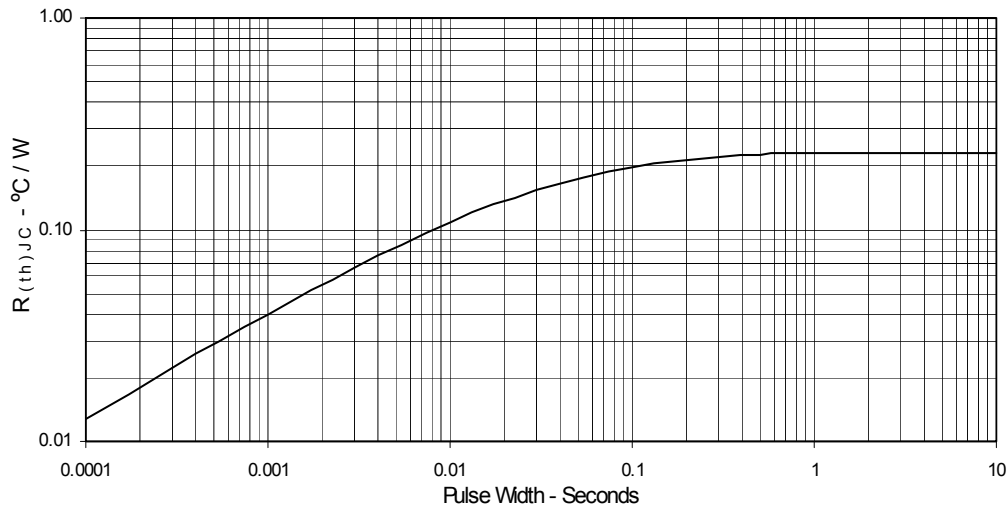

**TO-247 AD (IXTH) Outline**

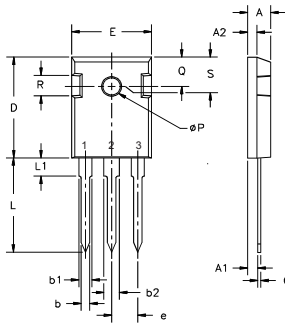

- Terminals:  
1 - Gate  
2 - Drain  
3 - Source

Dim.	Millimeter		Inches	
	Min.	Max.	Min.	Max.
A	4.7	5.3	.185	.209
A <sub>1</sub>	2.2	2.54	.087	.102
A <sub>2</sub>	2.2	2.6	.059	.098
b	1.0	1.4	.040	.055
b <sub>1</sub>	1.65	2.13	.065	.084
b <sub>2</sub>	2.87	3.12	.113	.123
C	.4	.8	.016	.031
D	20.80	21.46	.819	.845
E	15.75	16.26	.610	.640
e	5.20	5.72	0.205	0.225
L	19.81	20.32	.780	.800
L <sub>1</sub>		4.50		.177
ØP	3.55	3.65	.140	.144
Q	5.89	6.40	0.232	0.252
R	4.32	5.49	.170	.216
S	6.15	BSC	.242	BSC

**TO-3P (IXTQ) Outline**

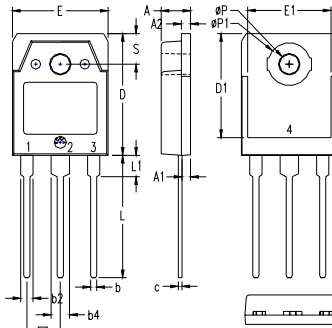

- 1 - GATE  
2 - DRAIN (COLLECTOR)  
3 - SOURCE (EMITTER)  
4 - DRAIN (COLLECTOR)

SYM	INCHES		MILLIMETERS	
	MIN	MAX	MIN	MAX
A	.185	.193	4.70	4.90
A <sub>1</sub>	.051	.059	1.30	1.50
A <sub>2</sub>	.057	.065	1.45	1.65
b	.035	.045	0.90	1.15
b <sub>2</sub>	.075	.087	1.90	2.20
b <sub>4</sub>	.114	.126	2.90	3.20
c	.022	.031	0.55	0.80
D	.780	.799	19.80	20.30
D <sub>1</sub>	.665	.677	16.90	17.20
E	.610	.622	15.50	15.80
E <sub>1</sub>	.531	.539	13.50	13.70
e	.215 BSC		5.45 BSC	
L	.779	.795	19.80	20.20
L <sub>1</sub>	.134	.142	3.40	3.60
ØP <sub>1</sub>	.126	.134	3.20	3.40
S	.272	.280	6.90	7.10
S	.193	.201	4.90	5.10

**TO-268 (IXTT) Outline**

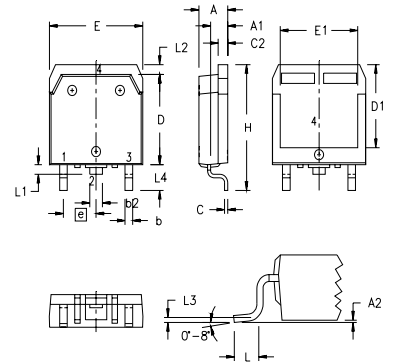

SYM	INCHES		MILLIMETERS	
	MIN	MAX	MIN	MAX
A	.193	.201	4.90	5.10
A <sub>1</sub>	.106	.114	2.70	2.90
A <sub>2</sub>	.001	.010	0.02	0.25
b	.045	.057	1.15	1.45
b <sub>2</sub>	.075	.083	1.90	2.10
C	.016	.026	0.40	0.65
C <sub>2</sub>	.057	.063	1.45	1.60
D	.543	.551	13.80	14.00
D <sub>1</sub>	.488	.500	12.40	12.70
E	.624	.632	15.85	16.05
E <sub>1</sub>	.524	.535	13.30	13.60
e	.215 BSC		5.45 BSC	
H	.736	.752	18.70	19.10
L	.094	.106	2.40	2.70
L <sub>1</sub>	.047	.055	1.20	1.40
L <sub>2</sub>	.039	.045	1.00	1.15
L <sub>3</sub>	.010 BSC		0.25 BSC	
L <sub>4</sub>	.150	.161	3.80	4.10

**PLUS220 (IXTV) Outline**

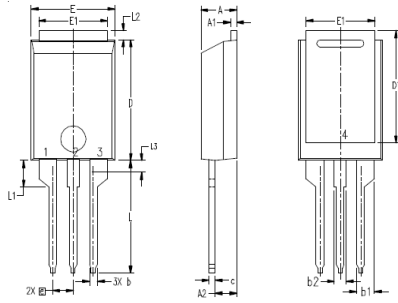

1. GATE  
2. DRAIN (COLLECTOR)  
3. SOURCE (EMITTER)  
4. DRAIN (COLLECTOR)

SYM	INCHES		MILLIMETER	
	MIN	MAX	MIN	MAX
A	.169	.185	4.30	4.70
A <sub>1</sub>	.028	.035	0.70	0.90
A <sub>2</sub>	.098	.118	2.50	3.00
b	.035	.047	0.90	1.20
b <sub>1</sub>	.080	.095	2.03	2.41
b <sub>2</sub>	.054	.064	1.37	1.63
c	.028	.035	0.70	0.90
D	.551	.591	14.00	15.00
D <sub>1</sub>	.512	.539	13.00	13.70
E	.394	.433	10.00	11.00
E <sub>1</sub>	.331	.346	8.40	8.80
e	.100 BSC		2.54 BSC	
L	.512	.551	13.00	14.00
L <sub>1</sub>	.118	.138	3.00	3.50
L <sub>2</sub>	.035	.051	0.90	1.30
L <sub>3</sub>	.047	.059	1.20	1.50

**PLUS220SMD (IXTV\_S) Outline**

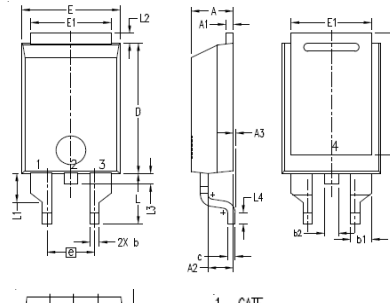

1. GATE  
2. DRAIN (COLLECTOR)  
3. SOURCE (EMITTER)  
4. DRAIN (COLLECTOR)

SYM	INCHES		MILLIMETER	
	MIN	MAX	MIN	MAX
A	.169	.185	4.30	4.70
A <sub>1</sub>	.028	.035	0.70	0.90
A <sub>2</sub>	.098	.118	2.50	3.00
b	.035	.047	0.90	1.20
b <sub>1</sub>	.080	.095	2.03	2.41
b <sub>2</sub>	.054	.064	1.37	1.63
c	.028	.035	0.70	0.90
D	.551	.591	14.00	15.00
D <sub>1</sub>	.512	.539	13.00	13.70
E	.394	.433	10.00	11.00
E <sub>1</sub>	.331	.346	8.40	8.80
e	.200 BSC		5.08 BSC	
L	.209	.228	5.30	5.80
L <sub>1</sub>	.118	.138	3.00	3.50
L <sub>2</sub>	.035	.051	0.90	1.30
L <sub>3</sub>	.047	.059	1.20	1.50
L <sub>4</sub>	.039	.059	1.00	1.50



---

Disclaimer Notice - Information furnished is believed to be accurate and reliable. However, users should independently evaluate the suitability of and test each product selected for their own applications. Littelfuse products are not designed for, and may not be used in, all applications. Read complete Disclaimer Notice at [www.littelfuse.com/disclaimer-electronics](http://www.littelfuse.com/disclaimer-electronics).