

**Polar3™ High Voltage
Power MOSFET**
IXTF6N200P3

$$V_{DSS} = 2000V$$

$$I_{D25} = 4A$$

$$R_{DS(on)} \leq 4.2\Omega$$

(Electrically Isolated Tab)

N-Channel Enhancement Mode

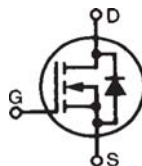

ISOPLUS i4-Pak™

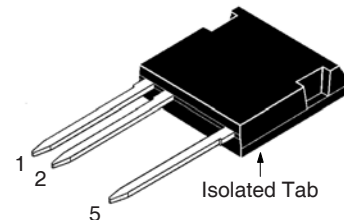
 1 = Gate 5 = Drain
2 = Source

Symbol	Test Conditions	Maximum Ratings	
V_{DSS}	$T_J = 25^\circ\text{C}$ to 150°C	2000	V
V_{DGR}	$T_J = 25^\circ\text{C}$ to 150°C , $R_{GS} = 1M\Omega$	2000	V
V_{GSS}	Continuous	± 20	V
V_{GSM}	Transient	± 30	V
I_{D25}	$T_C = 25^\circ\text{C}$	4.0	A
I_{D110}	$T_C = 110^\circ\text{C}$	2.3	A
I_{DM}	$T_C = 25^\circ\text{C}$, Pulse Width Limited by T_{JM}	18.0	A
P_D	$T_C = 25^\circ\text{C}$	215	W
T_J		- 55 ... +150	$^\circ\text{C}$
T_{JM}		150	$^\circ\text{C}$
T_{stg}		- 55 ... +150	$^\circ\text{C}$
T_L	Maximum Lead Temperature for Soldering	300	$^\circ\text{C}$
T_{SOLD}	1.6 mm (0.062in.) from Case for 10s	260	$^\circ\text{C}$
F_C	Mounting Force	20..120 / 4.5..27	N/lb
V_{ISOL}	50/60Hz, 1 Minute	2500	V~
Weight		6	g

Features

- Silicon Chip on Direct-Copper Bond (DCB) Substrate
- Isolated Mounting Surface
- 2500V~ Electrical Isolation
- High Blocking Voltage
- High Voltage Package

Advantages

- Easy to Mount
- Space Savings
- High Power Density

Applications

- High Voltage Power Supplies
- Capacitor Discharge Applications
- Pulse Circuits
- Laser and X-Ray Generation Systems

Symbol	Test Conditions ($T_J = 25^\circ\text{C}$, Unless Otherwise Specified)	Characteristic Values		
		Min.	Typ.	Max.
BV_{DSS}	$V_{GS} = 0V$, $I_D = 250\mu\text{A}$	2000		V
$V_{GS(th)}$	$V_{DS} = V_{GS}$, $I_D = 250\mu\text{A}$	3.0		5.0 V
I_{GSS}	$V_{GS} = \pm 20V$, $V_{DS} = 0V$			± 100 nA
I_{DSS}	$V_{DS} = 0.8 \cdot V_{DSS}$, $V_{GS} = 0V$ Note 2, $T_J = 100^\circ\text{C}$		150	25 μA μA
$R_{DS(on)}$	$V_{GS} = 10V$, $I_D = 3A$, Note 1			4.2 Ω

Symbol	Test Conditions ($T_J = 25^\circ\text{C}$, Unless Otherwise Specified)	Characteristic Values		
		Min.	Typ.	Max.
g_{fs}	$V_{DS} = 30\text{V}, I_D = 3\text{A}$, Note 1	4.5	7.5	S
C_{iss}	$V_{GS} = 0\text{V}, V_{DS} = 25\text{V}, f = 1\text{MHz}$		3700	pF
C_{oss}			236	pF
C_{rss}			104	pF
R_{Gi}	Gate Input Resistance		2.5	Ω
$t_{d(on)}$	Resistive Switching Times $V_{GS} = 10\text{V}, V_{DS} = 500\text{V}, I_D = 3\text{A}$ $R_G = 2\Omega$ (External)		28	ns
t_r			22	ns
$t_{d(off)}$			80	ns
t_f			46	ns
$Q_{g(on)}$	$V_{GS} = 10\text{V}, V_{DS} = 0.5 \cdot V_{DSS}, I_D = 3\text{A}$		143	nC
Q_{gs}			21	nC
Q_{gd}			70	nC
R_{thJC}				0.58 $^\circ\text{C/W}$
R_{thCS}		0.15		$^\circ\text{C/W}$

Source-Drain Diode

Symbol	Test Conditions ($T_J = 25^\circ\text{C}$, Unless Otherwise Specified)	Characteristic Values		
		Min.	Typ.	Max.
I_S	$V_{GS} = 0\text{V}$			6 A
I_{SM}	Repetitive, Pulse Width Limited by T_{JM}			24 A
V_{SD}	$I_F = I_S, V_{GS} = 0\text{V}$, Note 1			1.5 V
t_{rr}	$I_F = 3\text{A}, -di/dt = 100\text{A}/\mu\text{s}$ $V_R = 100\text{V}, V_{GS} = 0\text{V}$		520	ns
Q_{RM}			580	nC
I_{RM}			2.2	A

Notes:

1. Pulse test, $t \leq 300\mu\text{s}$, duty cycle, $d \leq 2\%$.
2. Device must be heatsunk for high-temperature leakage current measurements to avoid thermal runaway.

ADVANCE TECHNICAL INFORMATION

The product presented herein is under development. The Technical Specifications offered are derived from a subjective evaluation of the design, based upon prior knowledge and experience, and constitute a "considered reflection" of the anticipated result. IXYS reserves the right to change limits, test conditions, and dimensions without notice.

IXYS Reserves the Right to Change Limits, Test Conditions, and Dimensions.

IXYS MOSFETs and IGBTs are covered	4,835,592	4,931,844	5,049,961	5,237,481	6,162,665	6,404,065 B1	6,683,344	6,727,585	7,005,734 B2	7,157,338B2
by one or more of the following U.S. patents:	4,860,072	5,017,508	5,063,307	5,381,025	6,259,123 B1	6,534,343	6,710,405 B2	6,759,692	7,063,975 B2	
	4,881,106	5,034,796	5,187,117	5,486,715	6,306,728 B1	6,583,505	6,710,463	6,771,478 B2	7,071,537	

Fig. 1. Output Characteristics @ $T_J = 25^\circ\text{C}$

Fig. 2. Output Characteristics @ $T_J = 125^\circ\text{C}$

Fig. 3. $R_{DS(on)}$ Normalized to $I_D = 3\text{A}$ Value vs. Junction Temperature

Fig. 4. $R_{DS(on)}$ Normalized to $I_D = 3\text{A}$ Value vs. Drain Current

Fig. 5. Maximum Drain Current vs. Case Temperature

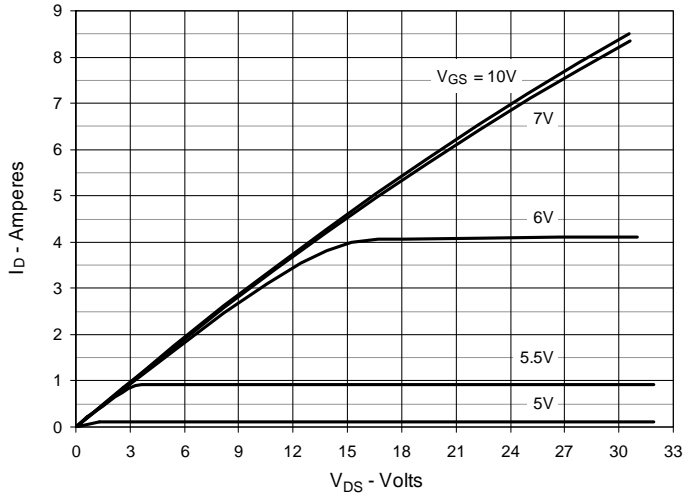
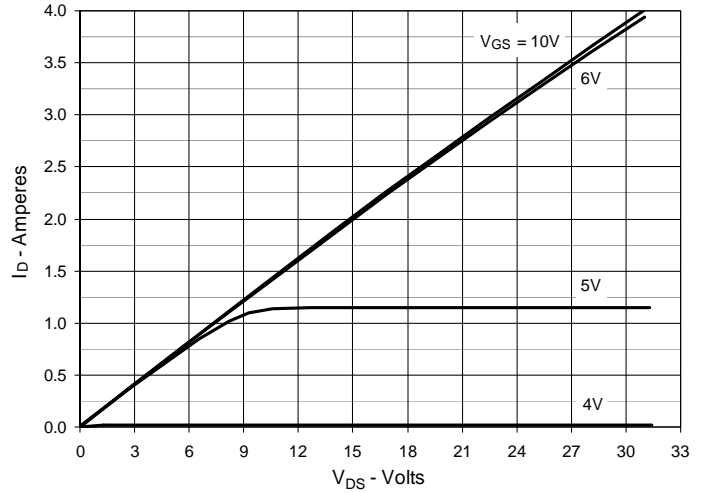
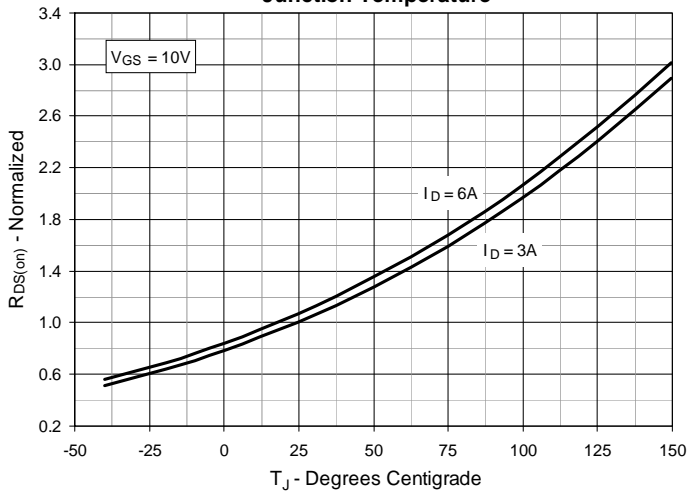
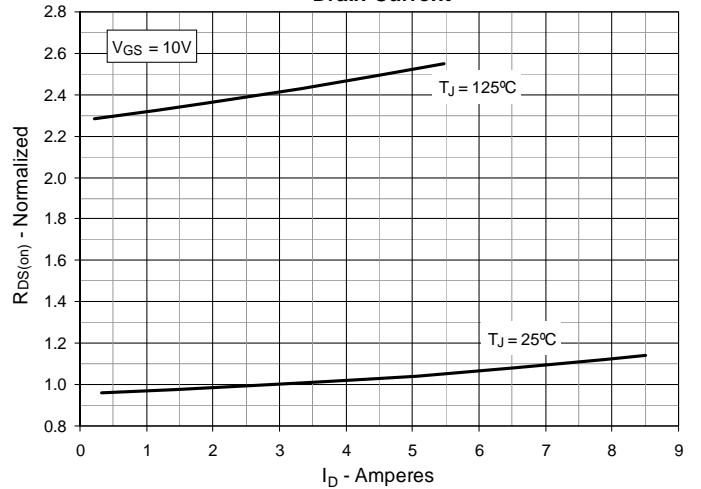
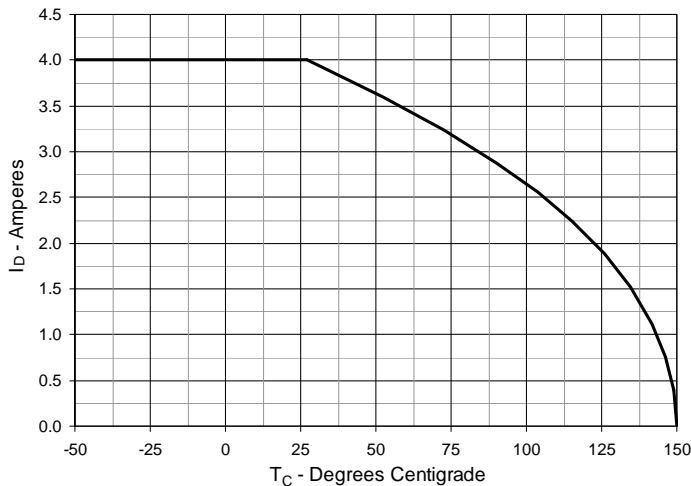
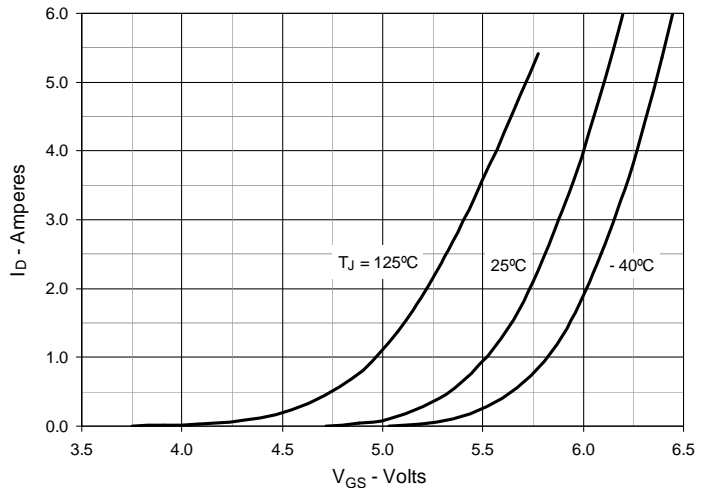
Fig. 6. Input Admittance

Fig. 7. Transconductance

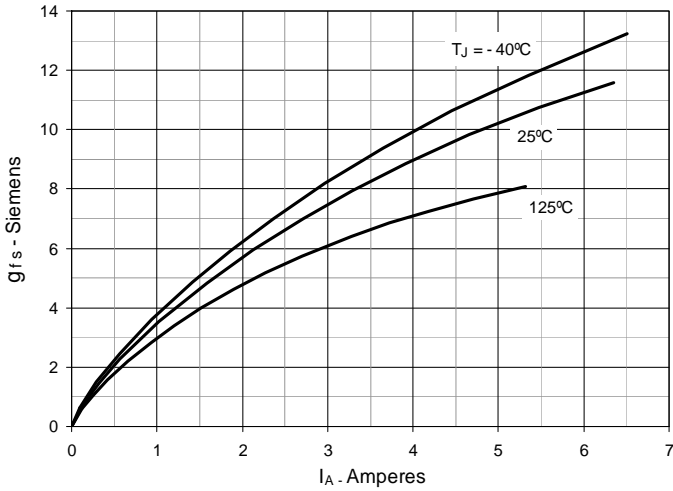

Fig. 8. Forward Voltage Drop of Intrinsic Diode

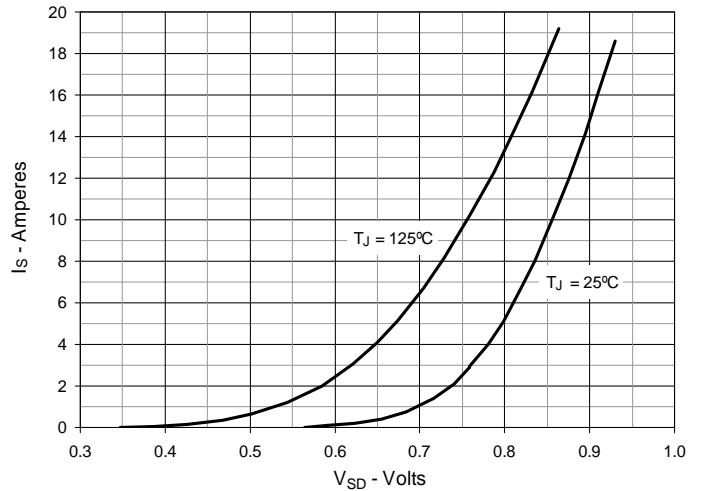

Fig. 9. Gate Charge

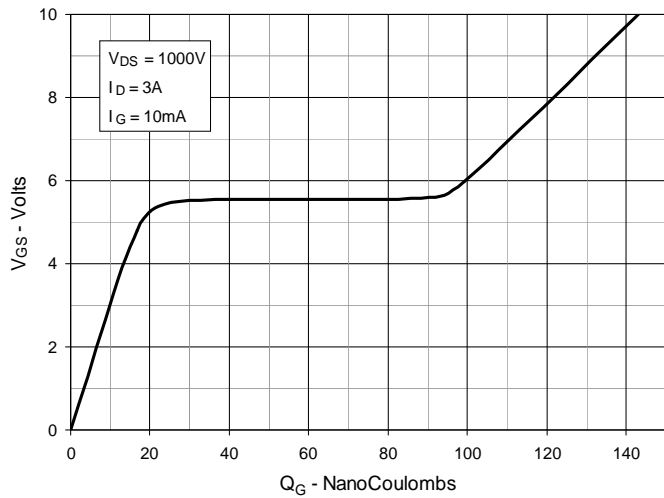

Fig. 10. Capacitance

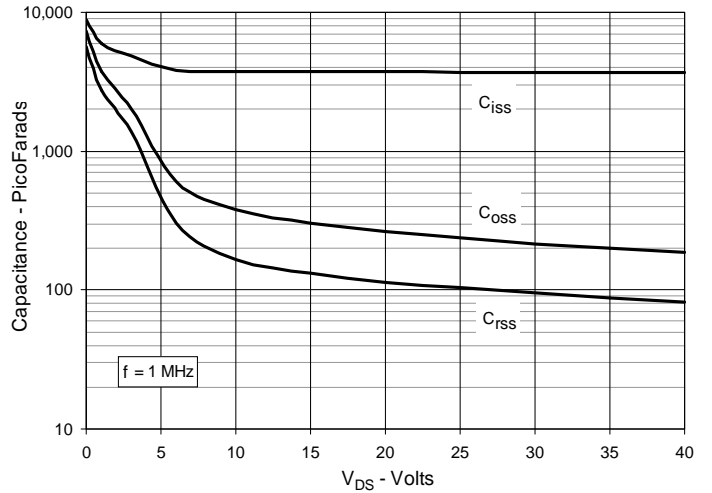

Fig. 11. Forward-Bias Safe Operating Area

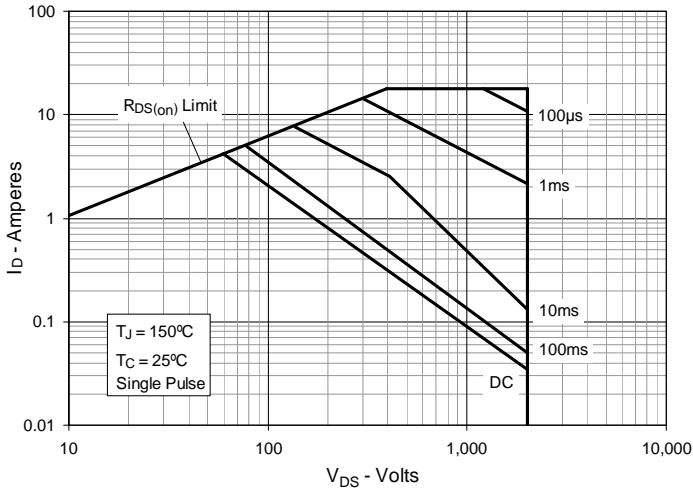
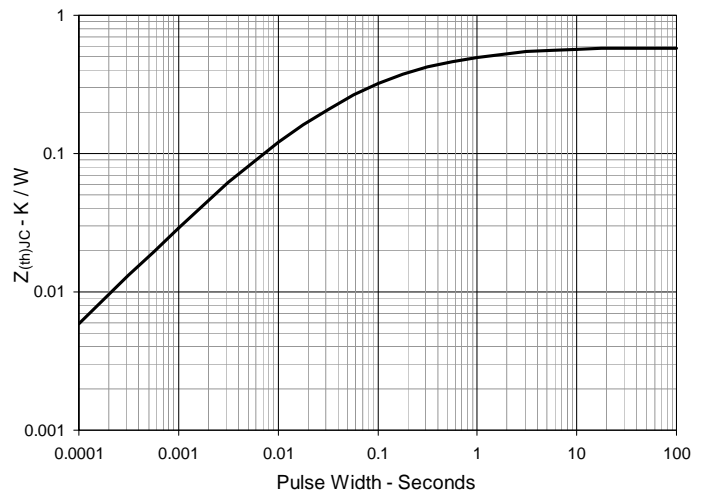
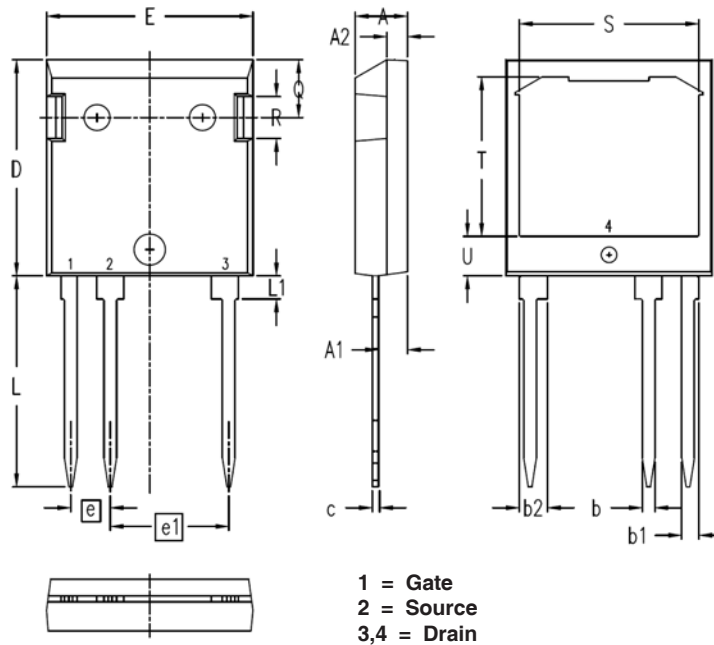

Fig. 12. Maximum Transient Thermal Impedance



ISOPLUS i4-Pak Outline

SYM	INCHES		MILLIMETERS	
	MIN	MAX	MIN	MAX
A	.193	.201	4.90	5.10
A1	.106	.114	2.70	2.90
A2	.075	.083	1.90	2.10
b	.047	.055	1.20	1.40
b1	.061	.069	1.55	1.75
b2	.087	.094	2.20	2.40
c	.020	.029	0.51	0.74
D	.819	.846	20.80	21.50
E	.768	.799	19.50	20.30
e	.150 BSC		3.81 BSC	
e1	.450 BSC		11.43 BSC	
L	.780	.838	19.80	21.30
L1	.083	.094	2.10	2.40
Q	.213	.236	5.40	6.00
R	.157	.169	4.00	4.30
S	.673	.685	17.10	17.40
T	.602	.614	15.30	15.60
U	.142	.154	3.60	3.90



Disclaimer Notice - Information furnished is believed to be accurate and reliable. However, users should independently evaluate the suitability of and test each product selected for their own applications. Littelfuse products are not designed for, and may not be used in, all applications. Read complete Disclaimer Notice at www.littelfuse.com/disclaimer-electronics.