

# High Voltage Power MOSFET

## IXTL2N470

$$V_{DSS} = 4700V$$

$$I_{D25} = 2A$$

$$R_{DS(on)} \leq 20\Omega$$

(Electrically Isolated Tab)

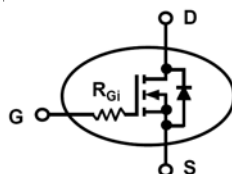

N-Channel Enhancement Mode

ISOPLUS i5-Pak™

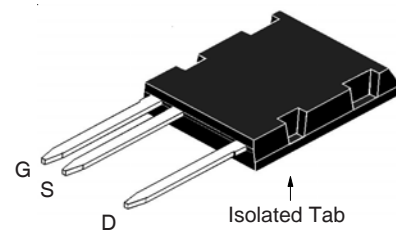

G = Gate  
D = Drain

S = Source

Symbol	Test Conditions	Maximum Ratings	
$V_{DSS}$	$T_J = 25^\circ C$ to $150^\circ C$	4700	V
$V_{DGR}$	$T_J = 25^\circ C$ to $150^\circ C$ , $R_{GS} = 1M\Omega$	4700	V
$V_{GSS}$	Continuous	$\pm 20$	V
$V_{GSM}$	Transient	$\pm 30$	V
$I_{D25}$	$T_C = 25^\circ C$	2	A
$I_{DM}$	$T_C = 25^\circ C$ , Pulse Width Limited by $T_{JM}$	8	A
$P_D$	$T_C = 25^\circ C$	220	W
$T_J$		- 55 ... +150	$^\circ C$
$T_{JM}$		150	$^\circ C$
$T_{stg}$		- 55 ... +150	$^\circ C$
$T_L$	Maximum Lead Temperature for Soldering	300	$^\circ C$
$T_{SOLD}$	Plastic Body for 10s	260	$^\circ C$
$F_C$	Mounting Force	20..120 / 4.5..27	N/lb.
$V_{ISOL}$	50/60Hz, 1 Minute	4000	V~
<b>Weight</b>		8	g

### Features

- Silicon Chip on Direct-Copper Bond (DCB) Substrate
- Isolated Mounting Surface
- 4000V~ RMS Electrical Isolation
- Molding Epoxies meet UL 94 V-0 Flammability Classification

### Advantages

- Easy to Mount
- Space Savings
- High Power Density

### Applications

- High Voltage Power Supplies
- Capacitor Discharge Applications
- Pulse Circuits
- Laser and X-Ray Generation Systems

Symbol	Test Conditions ( $T_J = 25^\circ C$ , Unless Otherwise Specified)	Characteristic Values		
		Min.	Typ.	Max.
$V_{GS(th)}$	$V_{DS} = V_{GS}$ , $I_D = 250\mu A$	3.5		6.0 V
$I_{GSS}$	$V_{GS} = \pm 20V$ , $V_{DS} = 0V$			$\pm 200$ nA
$I_{DSS}$	$V_{DS} = 3.6kV$ , $V_{GS} = 0V$			10 $\mu A$
	$V_{DS} = 4.7kV$			50 $\mu A$
	$V_{DS} = 3.6kV$ Note 2, $T_J = 125^\circ C$	250		$\mu A$
$R_{DS(on)}$	$V_{GS} = 10V$ , $I_D = 0.5 \cdot I_{D25}$ , Note 1			20 $\Omega$

Symbol	Test Conditions ( $T_J = 25^\circ\text{C}$ , Unless Otherwise Specified)	Characteristic Values		
		Min.	Typ.	Max.
$g_{fs}$	$V_{DS} = 60\text{V}$ , $I_D = 0.5 \cdot I_{D25}$ , Note 1	2.1	3.5	S
$C_{iss}$	$V_{GS} = 0\text{V}$ , $V_{DS} = 25\text{V}$ , $f = 1\text{MHz}$		6860	pF
$C_{oss}$			267	pF
$C_{rss}$			105	pF
$R_{Gi}$	Integrated Gate Input Resistance		4.0	$\Omega$
$t_{d(on)}$	<b>Resistive Switching Times</b> $V_{GS} = 10\text{V}$ , $V_{DS} = 1\text{kV}$ , $I_D = 1\text{A}$ $R_G = 0\Omega$ (External)		40	ns
$t_r$			34	ns
$t_{d(off)}$			123	ns
$t_f$			205	ns
$Q_{g(on)}$	$V_{GS} = 10\text{V}$ , $V_{DS} = 1\text{kV}$ , $I_D = 0.5 \cdot I_{D25}$		180	nC
$Q_{gs}$			34	nC
$Q_{gd}$			83	nC
$R_{thJC}$				0.56 $^\circ\text{C/W}$
$R_{thCS}$		0.15		$^\circ\text{C/W}$

**Source-Drain Diode**

Symbol	Test Conditions ( $T_J = 25^\circ\text{C}$ , Unless Otherwise Specified)	Characteristic Values		
		Min.	Typ.	Max.
$I_S$	$V_{GS} = 0\text{V}$			2 A
$I_{SM}$	Repetitive, Pulse Width Limited by $T_{JM}$			8 A
$V_{SD}$	$I_F = I_S$ , $V_{GS} = 0\text{V}$ , Note 1			3 V
$t_{rr}$	$I_F = 2\text{A}$ , $-di/dt = 100\text{A}/\mu\text{s}$ , $V_R = 100\text{V}$		1.75	$\mu\text{s}$

- Notes: 1. Pulse test,  $t \leq 300\mu\text{s}$ , duty cycle,  $d \leq 2\%$ .  
2. Part must be heatsunk for high-temp  $I_{dss}$  measurement.

**ADVANCE TECHNICAL INFORMATION**

The product presented herein is under development. The Technical Specifications offered are derived from a subjective evaluation of the design, based upon prior knowledge and experience, and constitute a "considered reflection" of the anticipated result. IXYS reserves the right to change limits, test conditions, and dimensions without notice.

IXYS Reserves the Right to Change Limits, Test Conditions, and Dimensions.

IXYS MOSFETs and IGBTs are covered	4,835,592	4,931,844	5,049,961	5,237,481	6,162,665	6,404,065 B1	6,683,344	6,727,585	7,005,734 B2	7,157,338B2
by one or more of the following U.S. patents:	4,860,072	5,017,508	5,063,307	5,381,025	6,259,123 B1	6,534,343	6,710,405 B2	6,759,692	7,063,975 B2	
	4,881,106	5,034,796	5,187,117	5,486,715	6,306,728 B1	6,583,505	6,710,463	6,771,478 B2	7,071,537	

**Fig. 1. Output Characteristics @  $T_J = 25^\circ\text{C}$**

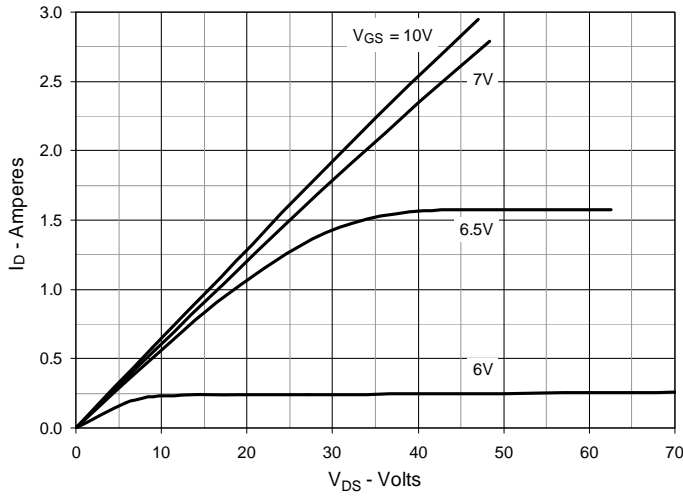

**Fig. 2. Output Characteristics @  $T_J = 125^\circ\text{C}$**

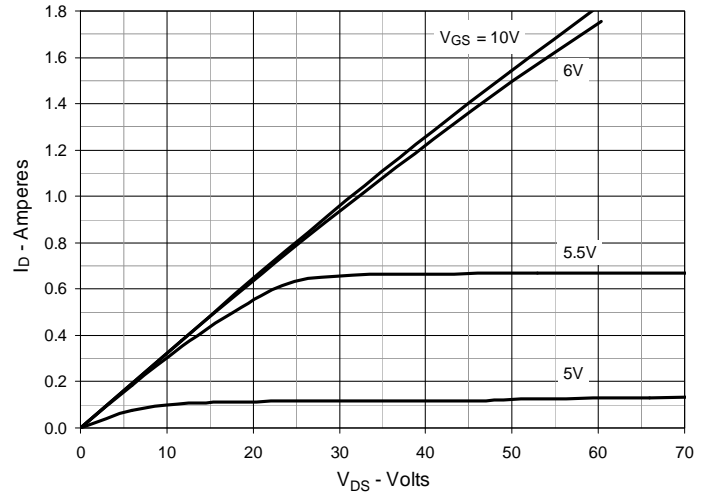

**Fig. 3.  $R_{DS(on)}$  Normalized to  $I_D = 1\text{A}$  Value vs. Junction Temperature**

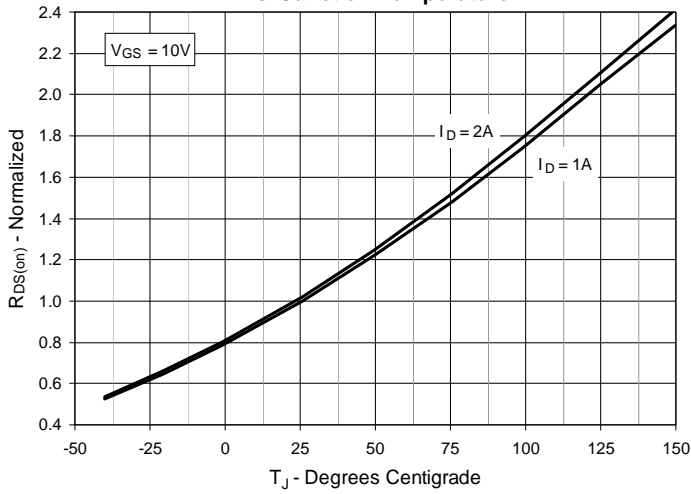

**Fig. 4.  $R_{DS(on)}$  Normalized to  $I_D = 1\text{A}$  Value vs. Drain Current**

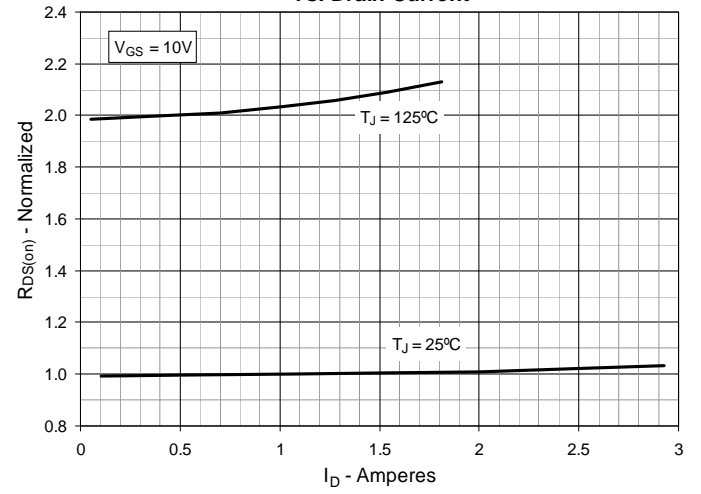

**Fig. 5. Maximum Drain Current vs. Case Temperature**

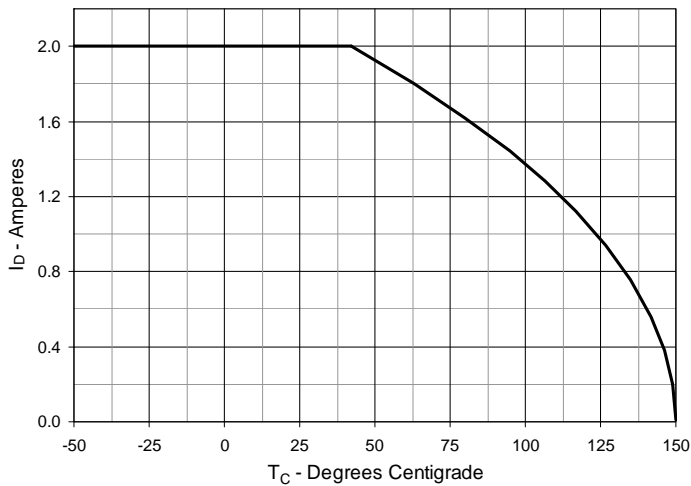

**Fig. 6. Input Admittance**

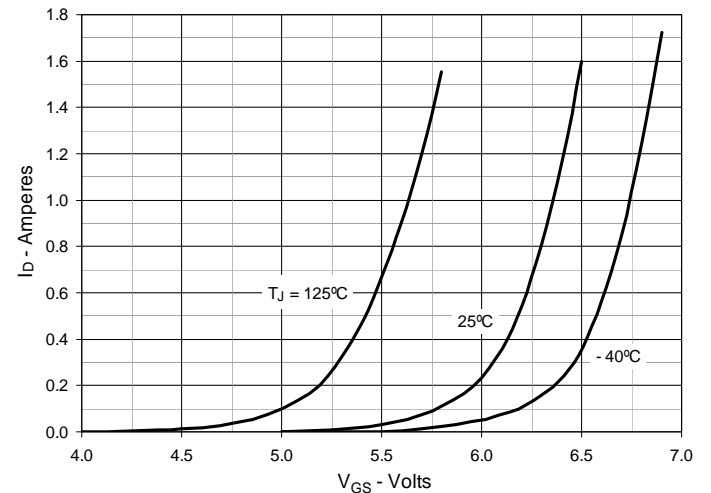

**Fig. 7. Transconductance**

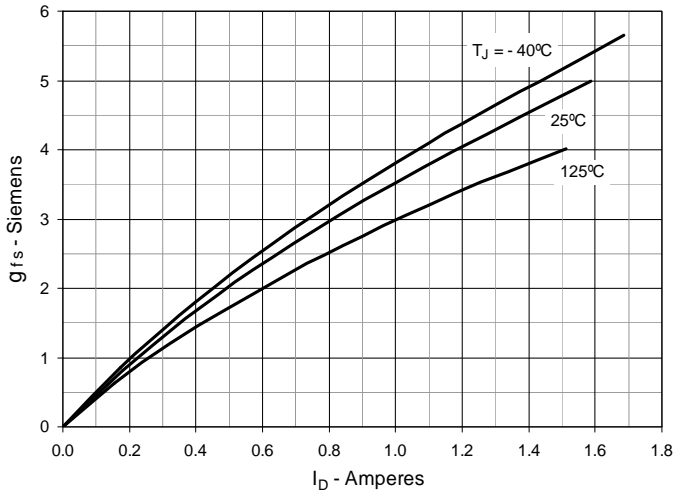

**Fig. 8. Forward Voltage Drop of Intrinsic Diode**

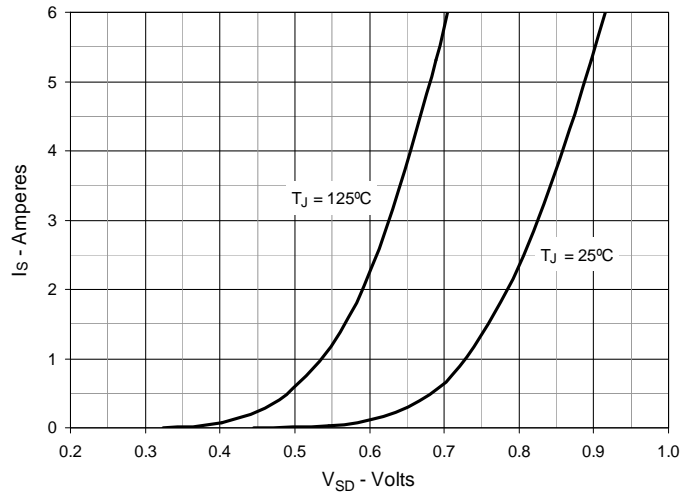

**Fig. 9. Gate Charge**

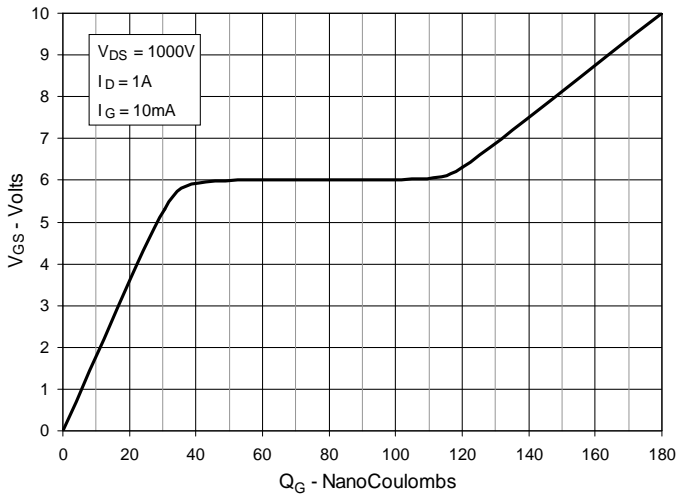

**Fig. 10. Capacitance**

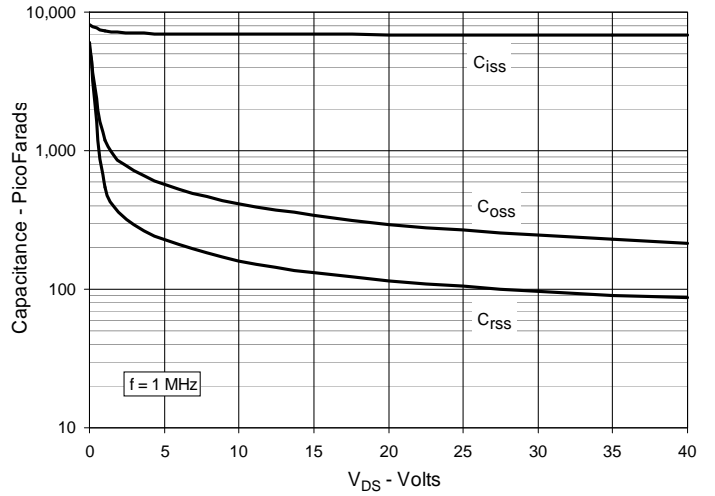

**Fig. 11. Forward-Bias Safe Operating Area**

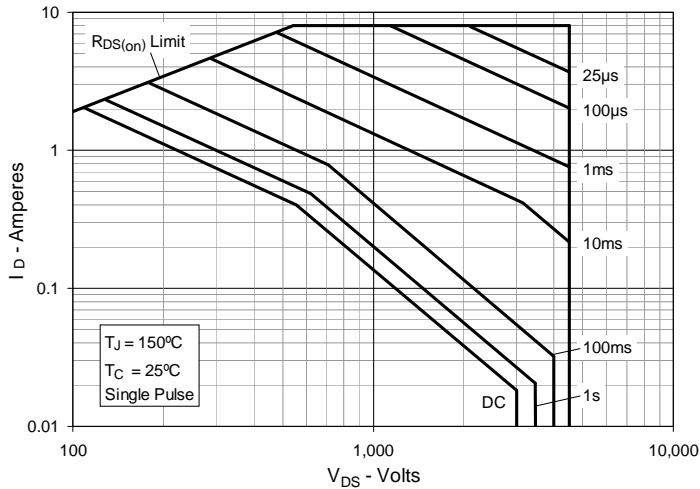

**Fig. 12. Resistive Switching Times vs. External Gate Resistance**

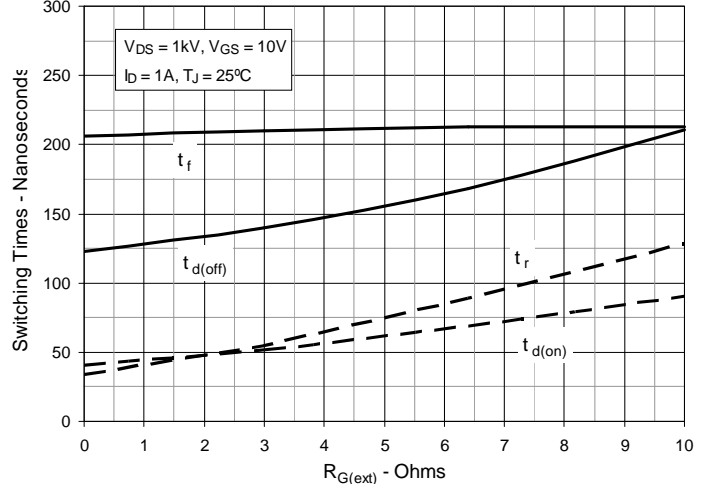
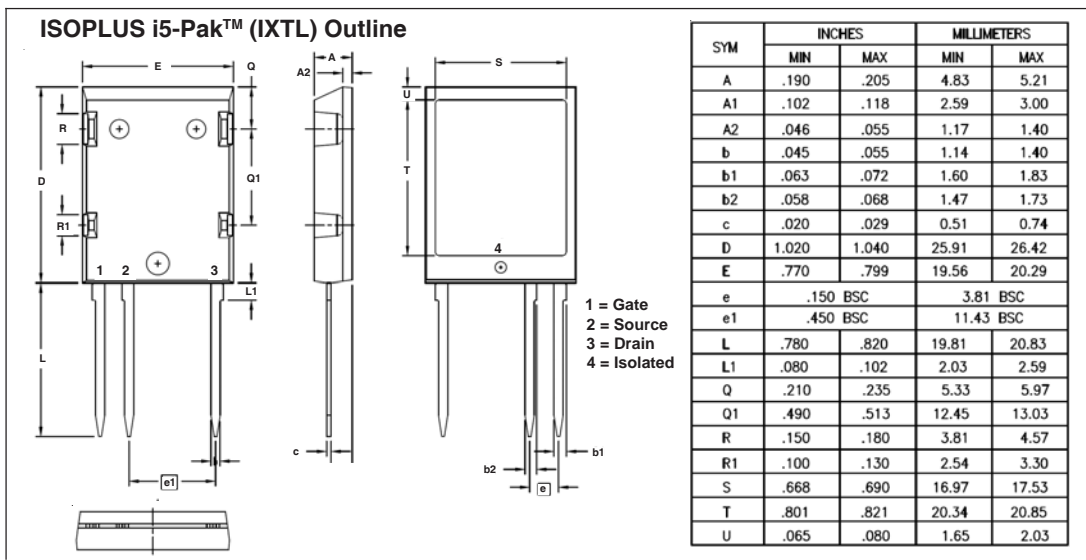
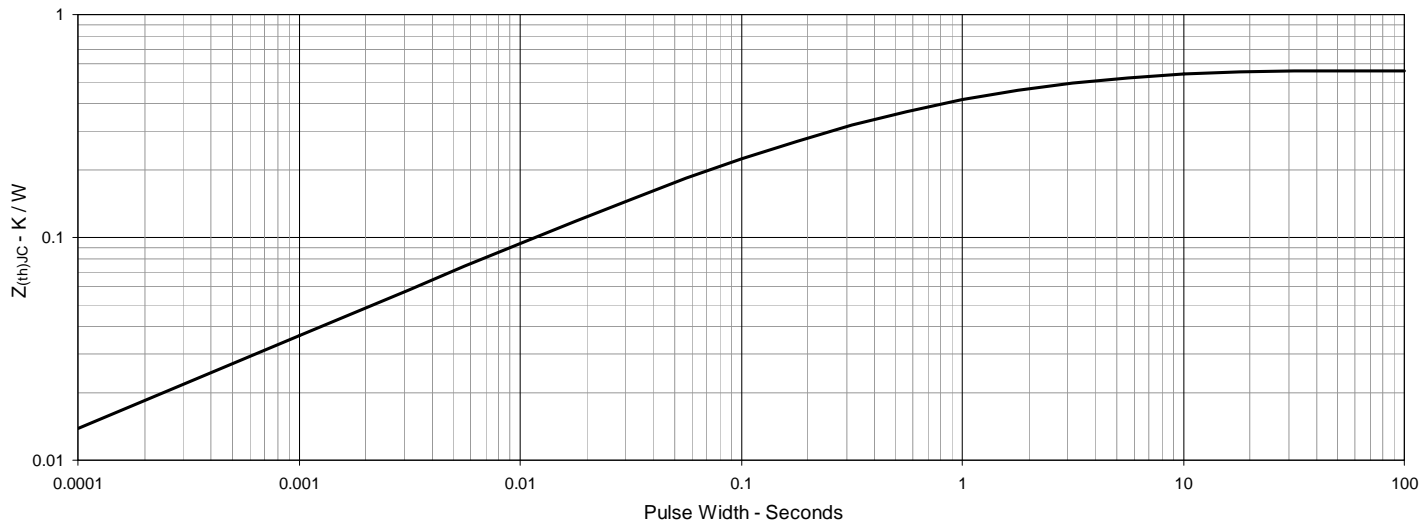

Fig. 13. Maximum Transient Thermal Impedance





---

Disclaimer Notice - Information furnished is believed to be accurate and reliable. However, users should independently evaluate the suitability of and test each product selected for their own applications. Littelfuse products are not designed for, and may not be used in, all applications. Read complete Disclaimer Notice at [www.littelfuse.com/disclaimer-electronics](http://www.littelfuse.com/disclaimer-electronics).