

CoolMOS™¹⁾ Power MOSFET

Electrically isolated back surface
 2500 V electrical isolation
 N-Channel Enhancement Mode
 Low $R_{DS(on)}$, high V_{DSS} MOSFET
 Ultra low gate charge



$$I_{D25} = 15 \text{ A}$$

$$V_{DSS} = 600 \text{ V}$$

$$R_{DS(on) \text{ max}} = 0.165 \Omega$$

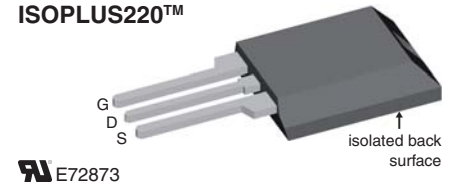
ISOPLUS220™

MOSFET			
Symbol	Conditions	Maximum Ratings	
V_{DSS}	$T_{VJ} = 25^\circ\text{C}$	600	V
V_{GS}		± 20	V
I_{D25}	$T_C = 25^\circ\text{C}$	15	A
I_{D90}	$T_C = 90^\circ\text{C}$	11	A
E_{AS} E_{AR}	single pulse repetitive } $I_D = 7.9 \text{ A}; T_C = 25^\circ\text{C}$	522 0.79	mJ mJ
dV/dt	MOSFET dV/dt ruggedness $V_{DS} = 0 \dots 480 \text{ V}$	50	V/ns

Features

- Silicon chip on Direct-Copper-Bond substrate
 - high power dissipation
 - isolated mounting surface
 - 2500 V electrical isolation
 - low drain to tab capacitance ($< 30 \text{ pF}$)
- Fast CoolMOS™¹⁾ power MOSFET 4th generation
 - high blocking capability
 - lowest resistance
 - avalanche rated for unclamped inductive switching (UIS)
 - low thermal resistance due to reduced chip thickness
- Enhanced total power density

Symbol	Conditions	Characteristic Values			
		$(T_{VJ} = 25^\circ\text{C}, \text{ unless otherwise specified})$			
		min.	typ.	max.	
$R_{DS(on)}$	$V_{GS} = 10 \text{ V}; I_D = 12 \text{ A}$		150	165	mΩ
$V_{GS(th)}$	$V_{DS} = V_{GS}; I_D = 0.79 \text{ mA}$	2.5	3	3.5	V
I_{DSS}	$V_{DS} = 600 \text{ V}; V_{GS} = 0 \text{ V}$			1	μA
				10	μA
I_{GSS}	$V_{GS} = \pm 20 \text{ V}; V_{DS} = 0 \text{ V}$			100	nA
C_{iss} C_{oss}	$V_{GS} = 0 \text{ V}; V_{DS} = 100 \text{ V}$ $f = 1 \text{ MHz}$		2000		pF
			100		pF
Q_g Q_{gs} Q_{gd}	$V_{GS} = 0 \text{ to } 10 \text{ V}; V_{DS} = 400 \text{ V}; I_D = 12 \text{ A}$		40	52	nC
			9		nC
			13		nC
$t_{d(on)}$ t_r $t_{d(off)}$ t_f	$V_{GS} = 10 \text{ V}; V_{DS} = 400 \text{ V}$ $I_D = 12 \text{ A}; R_G = 3.3 \Omega$		12		ns
			5		ns
			50		ns
			5		ns
R_{thJC}				1.1	K/W

Applications

- Switched mode power supplies (SMPS)
- Uninterruptible power supplies (UPS)
- Power factor correction (PFC)
- Welding
- Inductive heating
- PDP and LCD adapter

Advantages

- Easy assembly: no screws or isolation foils required
- Space savings
- High power density
- High reliability

¹⁾ CoolMOS™ is a trademark of Infineon Technologies AG.

Source-Drain Diode

Symbol	Conditions	Characteristic Values		
		min.	typ.	max.
($T_{VJ} = 25^{\circ}\text{C}$, unless otherwise specified)				
I_S	$V_{GS} = 0\text{ V}$		12	A
V_{SD}	$I_F = 12\text{ A}; V_{GS} = 0\text{ V}$	0.9	1.2	V
t_{rr}	$I_F = 12\text{ A}; -di_F/dt = 100\text{ A}/\mu\text{s}; V_R = 400\text{ V}$	390		ns
Q_{RM}		7.5		μC
I_{RM}		38		A

Component

Symbol	Conditions	Maximum Ratings		
		min.	typ.	max.
T_{VJ}	operating	-55...+150		$^{\circ}\text{C}$
T_{stg}	storage	-55...+150		$^{\circ}\text{C}$
V_{ISOL}	RMS leads-to-tab, 50/60 Hz, $f = 1$ minute		2500	V~
F_C	mounting force	11-65 / 2.4-11		N/lb

Symbol	Conditions	Characteristic Values		
		min.	typ.	max.
R_{thCH}	with heatsink compound	0.35		K/W
Weight		2.7		g

ISOPLUS220™ Outline

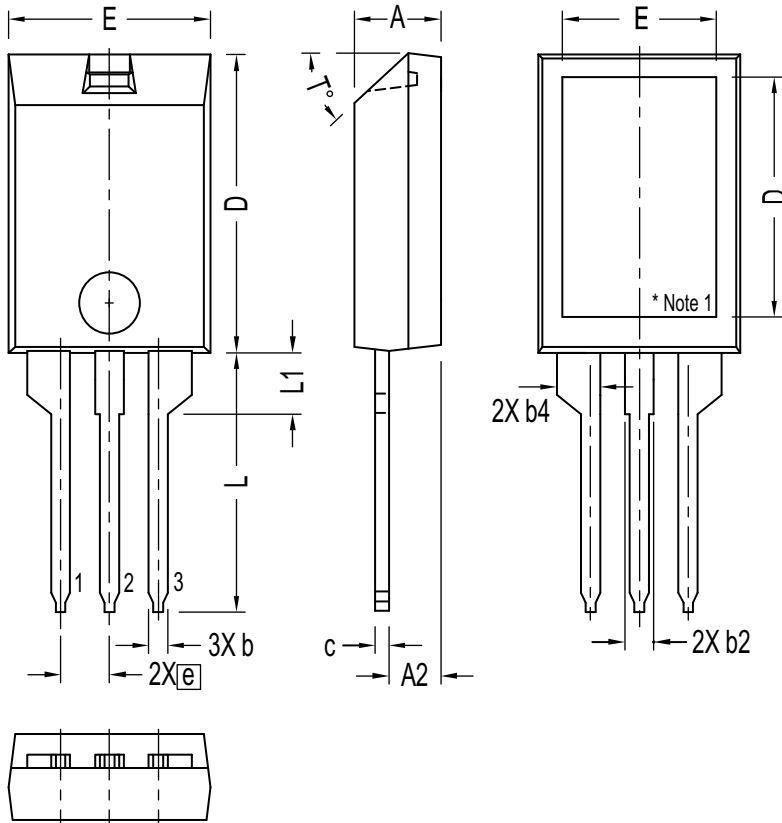

SYM	INCHES		MILLIMETERS	
	MIN	MAX	MIN	MAX
A	.157	.197	4.00	5.00
A2	.098	.118	2.50	3.00
b	.035	.051	0.90	1.30
b2	.049	.065	1.25	1.65
b4	.093	.100	2.35	2.55
c	.028	.039	0.70	1.00
D	.591	.630	15.00	16.00
D1	.472	.512	12.00	13.00
E	.394	.433	10.00	11.00
E1	.295	.335	7.50	8.50
e	.100 BASIC		2.55 BASIC	
L	.512	.571	13.00	14.50
L1	.118	.138	3.00	3.50
T°			42.5°	47.5°

NOTE:

1. Bottom heatsink is electrically isolated from Pin 1, 2, or 3.
2. This drawing will meet dimensional requirement of JEDEC SS Product Outline TO-273 except D and D1 dimension.

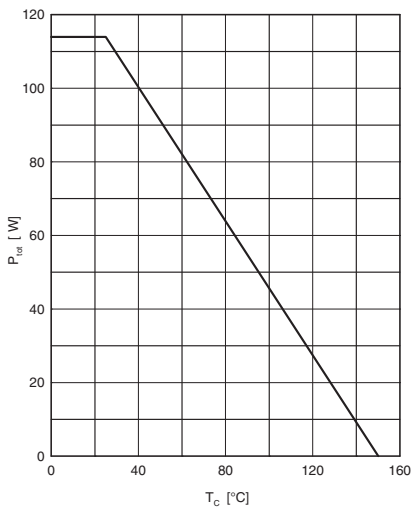

Fig. 1 Power dissipation

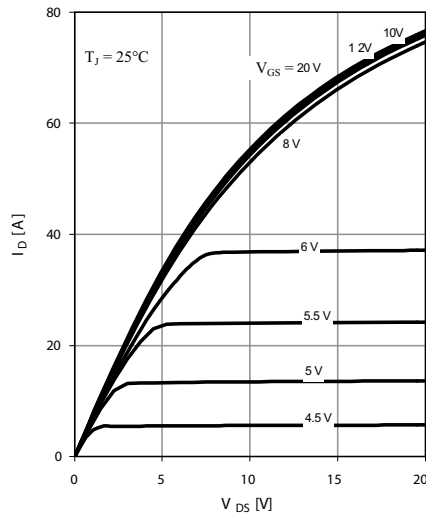

Fig. 2 Typ. output characteristics

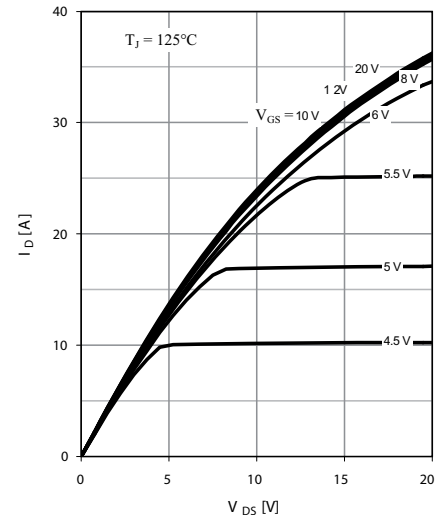

Fig. 3 Typ. output characteristics

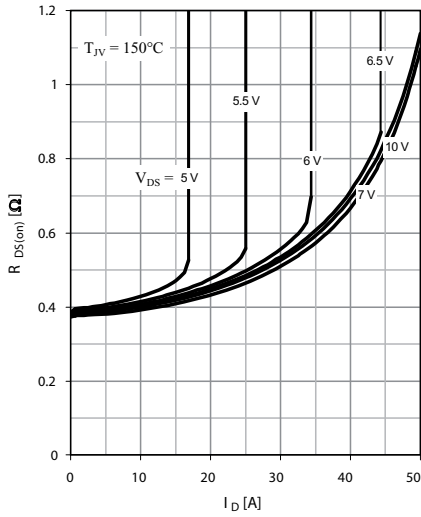

Fig. 4 Typ. drain-source on-state resistance

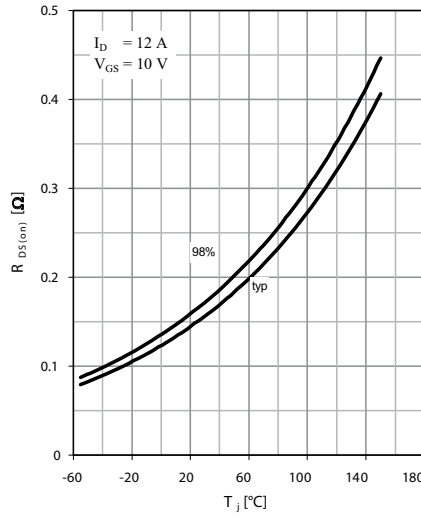

Fig. 5 Drain-source on-state resistance

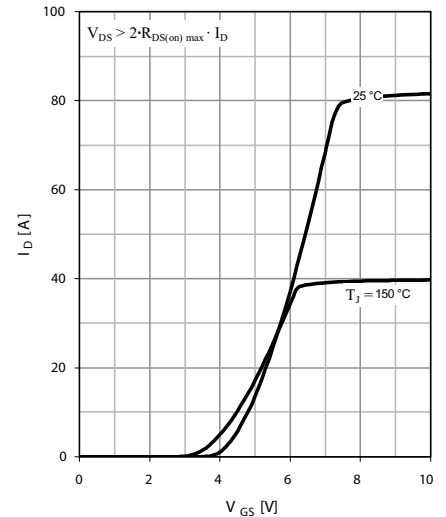

Fig. 6 Typ. transfer characteristics

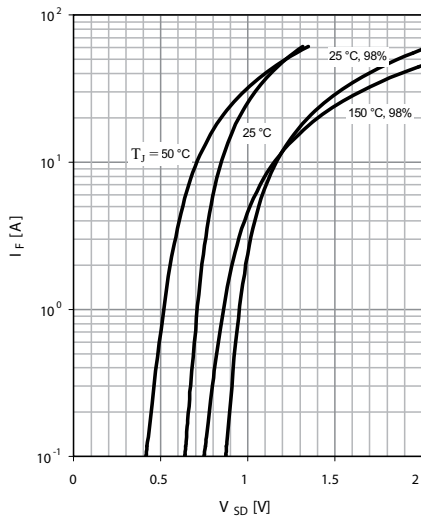

Fig. 7 Forward characteristic of reverse diode

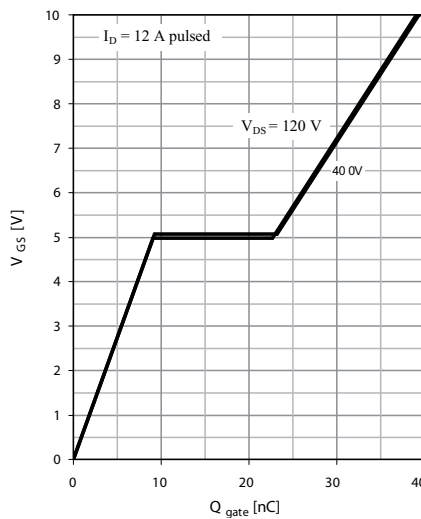

Fig. 8 Typ. gate charge

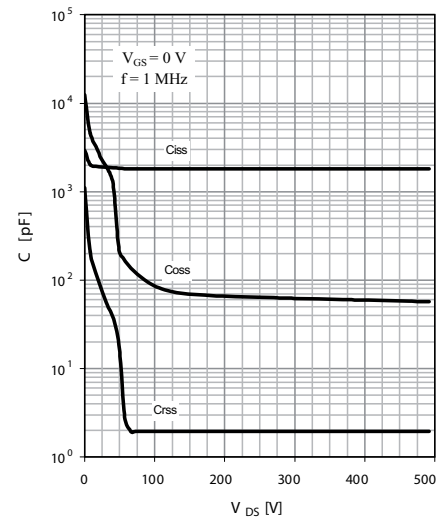

Fig. 9 Typ. capacitances

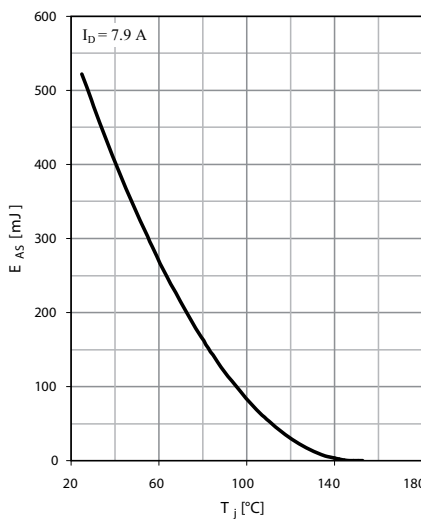

Fig. 10 Avalanche energy

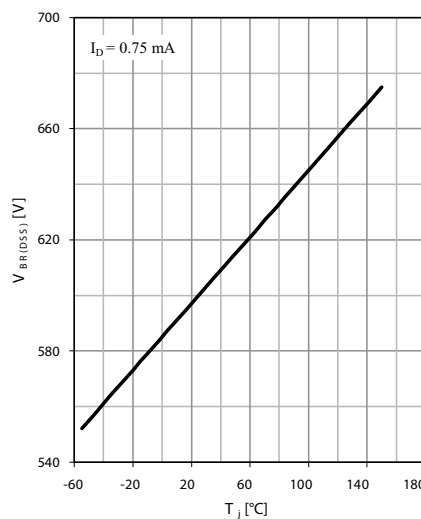

Fig. 11 Drain-source breakdown voltage

IXYS reserves the right to change limits, test conditions and dimensions.

20090209b



Disclaimer Notice - Information furnished is believed to be accurate and reliable. However, users should independently evaluate the suitability of and test each product selected for their own applications. Littelfuse products are not designed for, and may not be used in, all applications. Read complete Disclaimer Notice at www.littelfuse.com/disclaimer-electronics.