

# CoolMOS™ 1) Power MOSFET

Electrically isolated back surface  
 2500 V electrical isolation  
 N-Channel Enhancement Mode  
 Low  $R_{DS(on)}$ , high  $V_{DSS}$  MOSFET  
 Ultra low gate charge

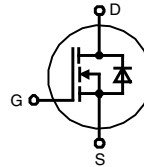
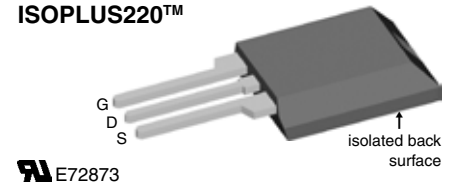

$I_{D25}$  = 23 A  
 $V_{DSS}$  = 600 V  
 $R_{DS(on) \text{ max}}$  = 0.1  $\Omega$

**ISOPLUS220™**

Preliminary data

MOSFET			
Symbol	Conditions	Maximum Ratings	
$V_{DSS}$	$T_{VJ} = 25^{\circ}\text{C}$	600	V
$V_{GS}$		$\pm 20$	V
$I_{D25}$	$T_C = 25^{\circ}\text{C}$	23	A
$I_{D90}$	$T_C = 90^{\circ}\text{C}$	16	A
$E_{AS}$	single pulse } $I_D = 11 \text{ A}; T_C = 25^{\circ}\text{C}$ repetitive }	800	mJ
$E_{AR}$		1.2	mJ
$dV/dt$	MOSFET $dV/dt$ ruggedness $V_{DS} = 0 \dots 480 \text{ V}$	50	V/ns

**Features**

- Silicon chip on Direct-Copper-Bond substrate
  - high power dissipation
  - isolated mounting surface
  - 2500 V electrical isolation
  - low drain to tab capacitance ( $< 30 \text{ pF}$ )
- Fast CoolMOS™ 1) power MOSFET 4<sup>th</sup> generation
  - high blocking capability
  - lowest resistance
  - avalanche rated for unclamped inductive switching (UIS)
  - low thermal resistance due to reduced chip thickness
- Enhanced total power density

Symbol	Conditions	Characteristic Values			
		$(T_{VJ} = 25^{\circ}\text{C}, \text{ unless otherwise specified})$			
		min.	typ.	max.	
$R_{DS(on)}$	$V_{GS} = 10 \text{ V}; I_D = 18 \text{ A}$		90	100	m $\Omega$
$V_{GS(th)}$	$V_{DS} = V_{GS}; I_D = 1.2 \text{ mA}$	2.5	3	3.5	V
$I_{DSS}$	$V_{DS} = 600 \text{ V}; V_{GS} = 0 \text{ V}$			5	$\mu\text{A}$
			50		$\mu\text{A}$
$I_{GSS}$	$V_{GS} = \pm 20 \text{ V}; V_{DS} = 0 \text{ V}$			100	nA
$C_{iss}$	} $V_{GS} = 0 \text{ V}; V_{DS} = 100 \text{ V}$ } $f = 1 \text{ MHz}$		2800		pF
$C_{oss}$				130	
$Q_g$	} $V_{GS} = 0 \text{ to } 10 \text{ V}; V_{DS} = 400 \text{ V}; I_D = 18 \text{ A}$		60	80	nC
$Q_{gs}$			14		nC
$Q_{gd}$			20		nC
$t_{d(on)}$	} $V_{GS} = 10 \text{ V}; V_{DS} = 400 \text{ V}$ } $I_D = 18 \text{ A}; R_G = 3.3 \Omega$		10		ns
$t_r$			5		ns
$t_{d(off)}$			60		ns
$t_f$			5		ns
$R_{thJC}$				0.85	K/W

**Applications**

- Switched mode power supplies (SMPS)
- Uninterruptible power supplies (UPS)
- Power factor correction (PFC)
- Welding
- Inductive heating
- PDP and LCD adapter

**Advantages**

- Easy assembly: no screws or isolation foils required
- Space savings
- High power density
- High reliability

<sup>1)</sup> CoolMOS™ is a trademark of Infineon Technologies AG.

**Source-Drain Diode**

Symbol	Conditions	Characteristic Values			
		min.	typ.	max.	
( $T_{VJ} = 25^{\circ}\text{C}$ , unless otherwise specified)					
$I_S$	$V_{GS} = 0\text{ V}$			16	A
$V_{SD}$	$I_F = 16\text{ A}; V_{GS} = 0\text{ V}$		0.9	1.2	V
$t_{rr}$	$I_F = 16\text{ A}; -di_F/dt = 100\text{ A}/\mu\text{s}; V_R = 400\text{ V}$		450		ns
$Q_{RM}$			12		$\mu\text{C}$
$I_{RM}$			70		A

**Component**

Symbol	Conditions	Maximum Ratings	
$T_{VJ}$	operating	-55...+150	$^{\circ}\text{C}$
$T_{stg}$	storage	-55...+150	$^{\circ}\text{C}$
$V_{ISOL}$	RMS leads-to-tab, 50/60 Hz, $f = 1$ minute	2500	V~
$F_C$	mounting force	11-65 / 2.4-11	N/lb

Symbol	Conditions	Characteristic Values		
		min.	typ.	max.
$R_{thCH}$	with heatsink compound		0.28	K/W
<b>Weight</b>			3.1	g

## ISOPLUS220™ Outline

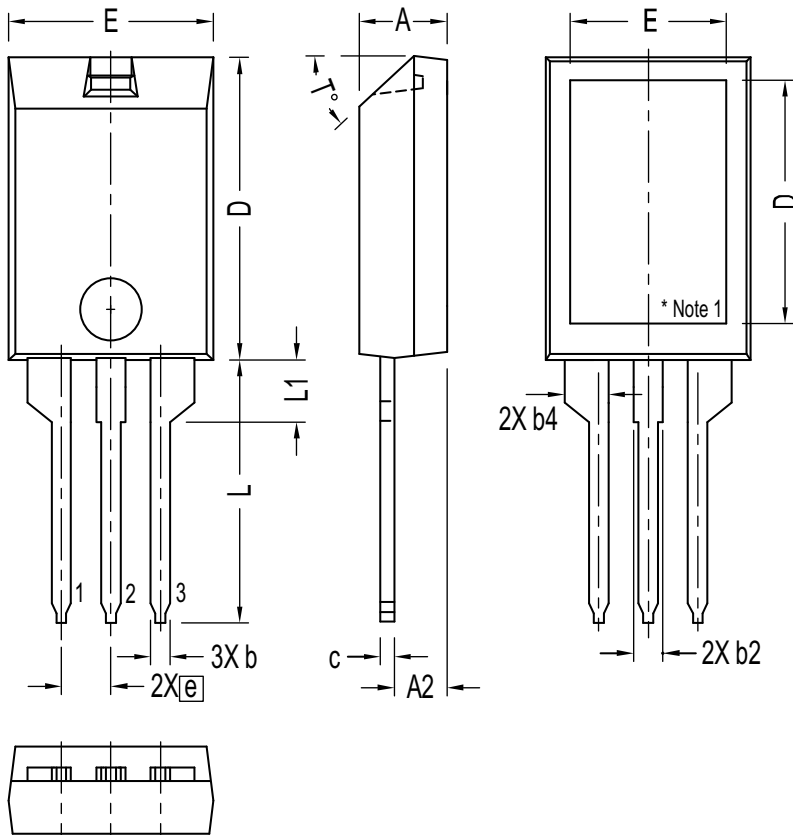

SYM	INCHES		MILLIMETERS	
	MIN	MAX	MIN	MAX
A	.157	.197	4.00	5.00
A2	.098	.118	2.50	3.00
b	.035	.051	0.90	1.30
b2	.049	.065	1.25	1.65
b4	.093	.100	2.35	2.55
c	.028	.039	0.70	1.00
D	.591	.630	15.00	16.00
D1	.472	.512	12.00	13.00
E	.394	.433	10.00	11.00
E1	.295	.335	7.50	8.50
e	.100 BASIC		2.55	BASIC
L	.512	.571	13.00	14.50
L1	.118	.138	3.00	3.50
T°			42.5°	47.5°

**NOTE:**

1. Bottom heatsink is electrically isolated from Pin 1, 2, or 3.
2. This drawing will meet dimensional requirement of JEDEC SS Product Outline TO-273 except D and D1 dimension.

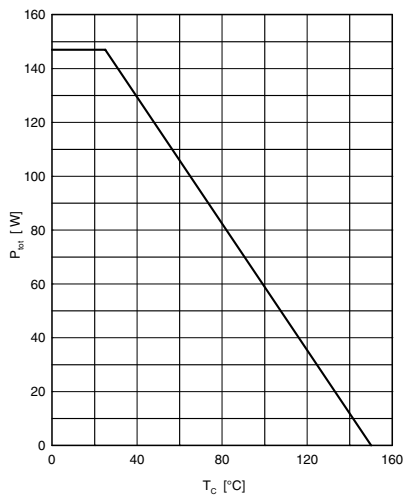

Fig. 1 Power dissipation

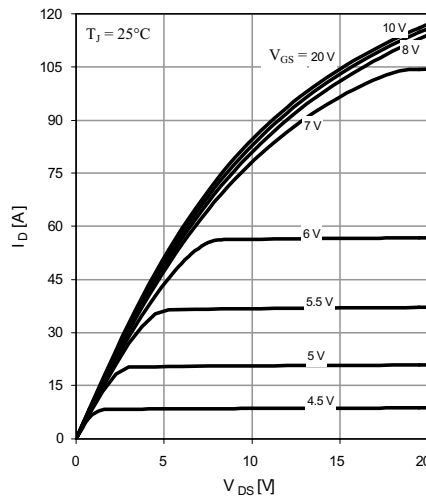

Fig. 2 Typ. output characteristics

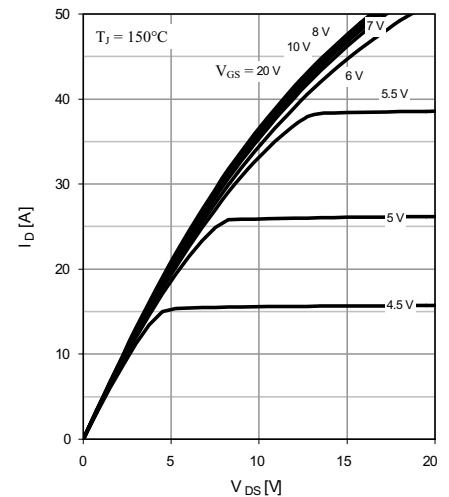

Fig. 3 Typ. output characteristics

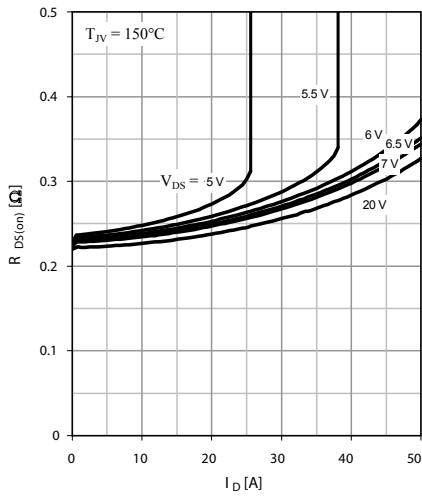

Fig. 4 Typ. drain-source on-state resistance characteristics

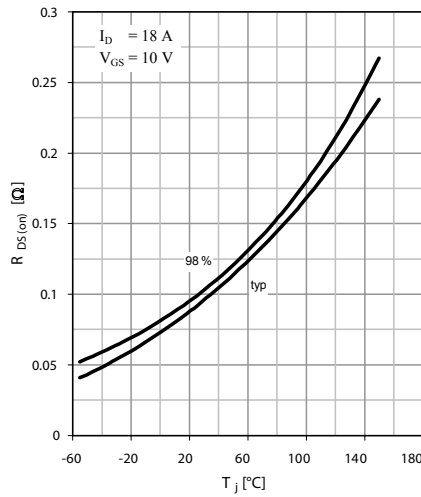

Fig. 5 Drain-source on-state resistance

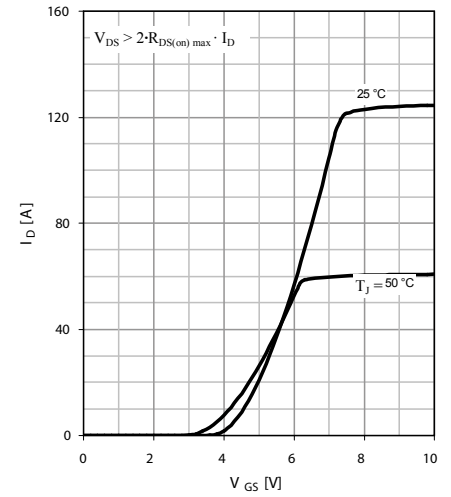

Fig. 6 Typ. transfer characteristics

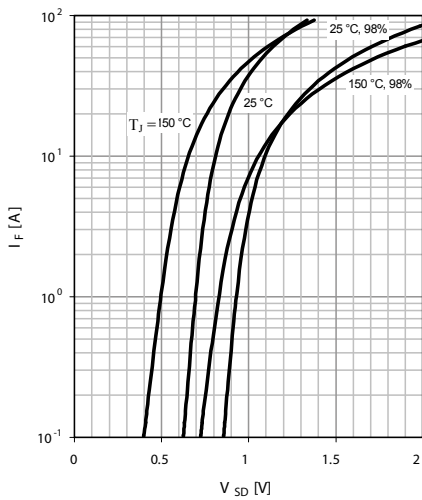

Fig. 7 Forward characteristic of reverse diode

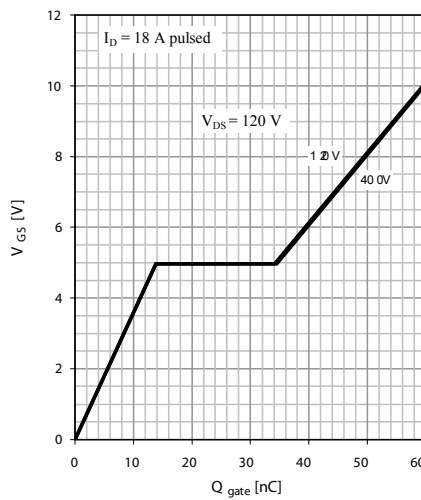

Fig. 8 Typ. gate charge

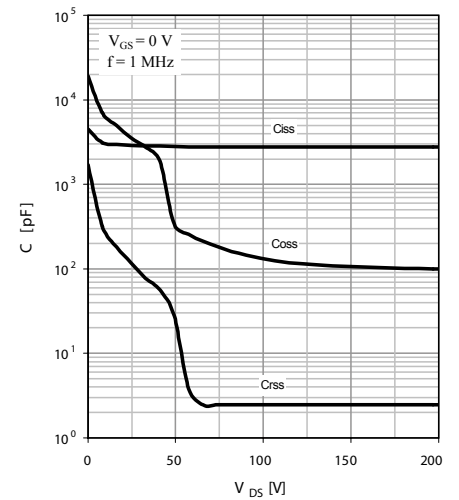

Fig. 9 Typ. capacitances

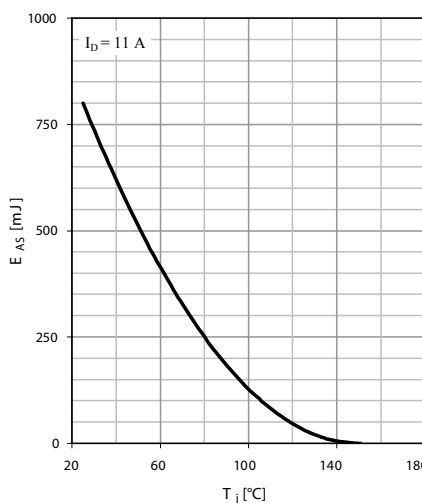

Fig. 10 Avalanche energy

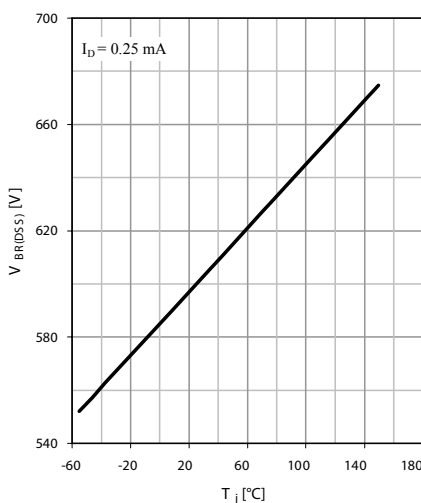

Fig. 11 Drain-source breakdown voltage

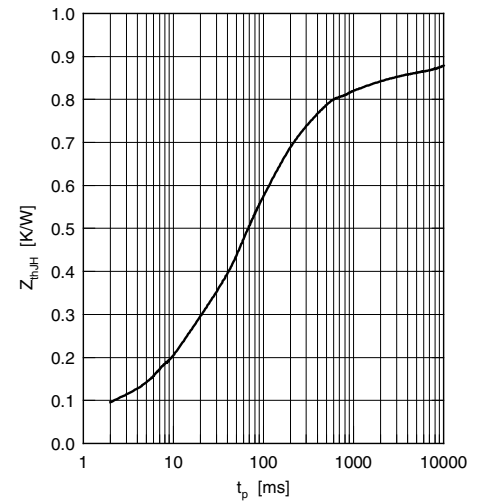

Fig. 12 Typ. transient thermal impedance with heat transfer paste



---

Disclaimer Notice - Information furnished is believed to be accurate and reliable. However, users should independently evaluate the suitability of and test each product selected for their own applications. Littelfuse products are not designed for, and may not be used in, all applications. Read complete Disclaimer Notice at [www.littelfuse.com/disclaimer-electronics](http://www.littelfuse.com/disclaimer-electronics).