

CoolMOS™ 1) Power MOSFET

N-Channel Enhancement Mode
 Low $R_{DS(on)}$, High V_{DSS} MOSFET
 Ultra low gate charge

I_{D25} = 70 A
 V_{DSS} = 600 V
 $R_{DS(on) max}$ = 0.045 Ω



TO-247 AD (IXKH)

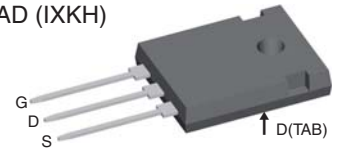

MOSFET			
Symbol	Conditions	Maximum Ratings	
V_{DSS}	$T_{VJ} = 25^{\circ}\text{C}$	600	V
V_{GS}		± 20	V
I_{D25}	$T_C = 25^{\circ}\text{C}$	70	A
I_{D90}	$T_C = 90^{\circ}\text{C}$	48	A
E_{AS} E_{AR}	single pulse repetitive } $I_D = 11 \text{ A}; T_C = 25^{\circ}\text{C}$	1950 3	mJ mJ
dV/dt	MOSFET dV/dt ruggedness $V_{DS} = 0 \dots 480 \text{ V}$	50	V/ns

Features

- fast CoolMOS™ 1) power MOSFET 4th generation
- High blocking capability
- Lowest resistance
- Avalanche rated for unclamped inductive switching (UIS)
- Low thermal resistance due to reduced chip thickness
- Enhanced total power density

Applications

- Switched mode power supplies (SMPS)
- Uninterruptible power supplies (UPS)
- Power factor correction (PFC)
- Welding
- Inductive heating
- PDP and LCD adapter

Symbol	Conditions	Characteristic Values			
		$(T_{VJ} = 25^{\circ}\text{C}, \text{ unless otherwise specified})$			
		min.	typ.	max.	
$R_{DS(on)}$	$V_{GS} = 10 \text{ V}; I_D = 44 \text{ A}$		40	45	m Ω
$V_{GS(th)}$	$V_{DS} = V_{GS}; I_D = 3 \text{ mA}$	2.5	3	3.5	V
I_{DSS}	$V_{DS} = 600 \text{ V}; V_{GS} = 0 \text{ V}$			10	μA
			50		μA
I_{GSS}	$V_{GS} = \pm 20 \text{ V}; V_{DS} = 0 \text{ V}$			100	nA
C_{iss}	} $V_{GS} = 0 \text{ V}; V_{DS} = 100 \text{ V}$ $f = 1 \text{ MHz}$		6800		pF
C_{oss}				320	
Q_g	} $V_{GS} = 0 \text{ to } 10 \text{ V}; V_{DS} = 400 \text{ V}; I_D = 44 \text{ A}$		150	190	nC
Q_{gs}			35		nC
Q_{gd}			50		nC
$t_{d(on)}$	} $V_{GS} = 10 \text{ V}; V_{DS} = 400 \text{ V}$ $I_D = 44 \text{ A}; R_G = 3.3 \Omega$		30		ns
t_r			20		ns
$t_{d(off)}$			100		ns
t_f			10		ns
R_{thJC}				0.2	K/W

¹⁾ CoolMOS™ is a trademark of Infineon Technologies AG.

Source-Drain Diode

Symbol	Conditions	Characteristic Values		
		min.	typ.	max.
($T_{VJ} = 25^{\circ}\text{C}$, unless otherwise specified)				
I_S	$V_{GS} = 0\text{ V}$		44	A
V_{SD}	$I_F = 44\text{ A}; V_{GS} = 0\text{ V}$	0.9	1.2	V
t_{rr}	} $I_F = 44\text{ A}; -di_F/dt = 100\text{ A}/\mu\text{s}; V_R = 400\text{ V}$	600		ns
Q_{RM}		17		μC
I_{RM}		60		A

Component

Symbol	Conditions	Maximum Ratings	
T_{VJ}	operating	-55...+150	$^{\circ}\text{C}$
T_{stg}		-55...+150	$^{\circ}\text{C}$
M_d	mounting torque	0.8 ... 1.2	Nm

Symbol	Conditions	Characteristic Values		
		min.	typ.	max.
R_{thCH}	with heatsink compound	0.25		K/W
Weight		6		g

TO-247 AD Outline

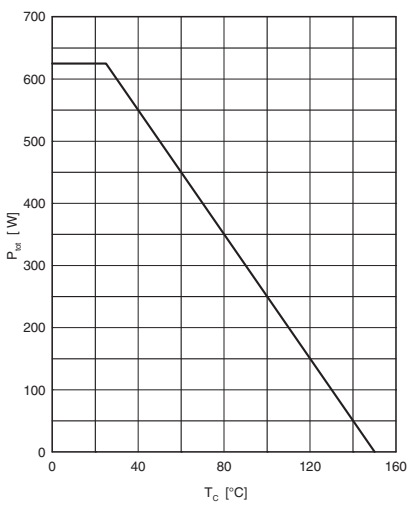
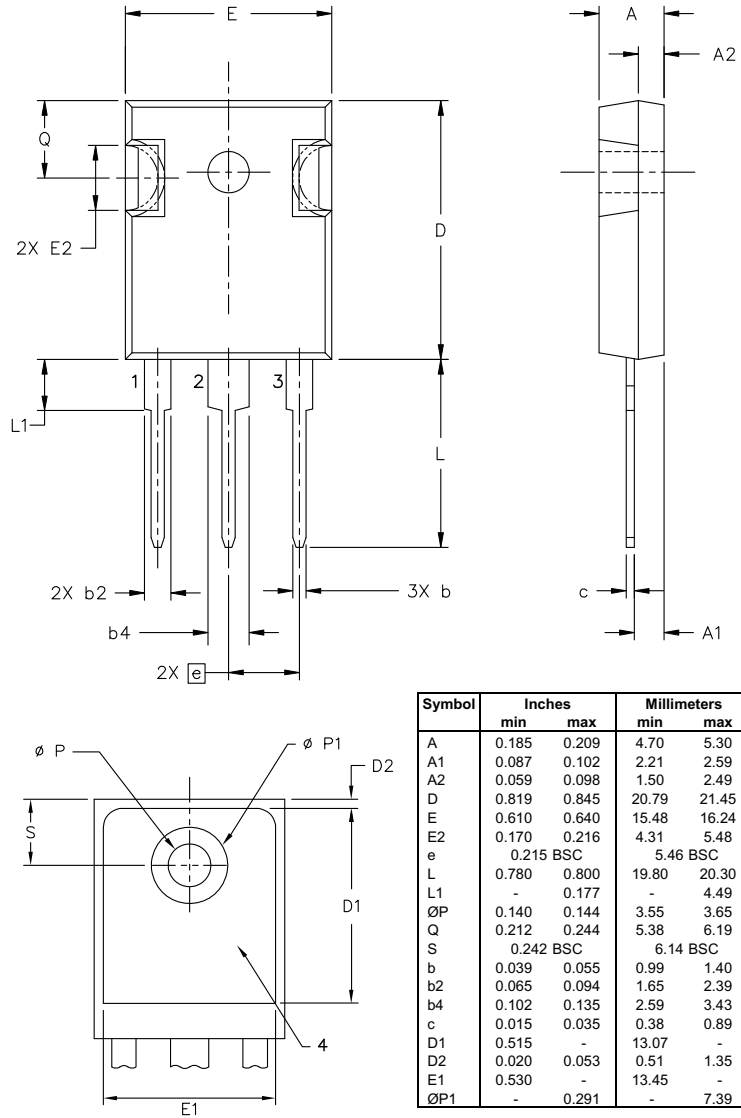

Fig. 1 Power dissipation

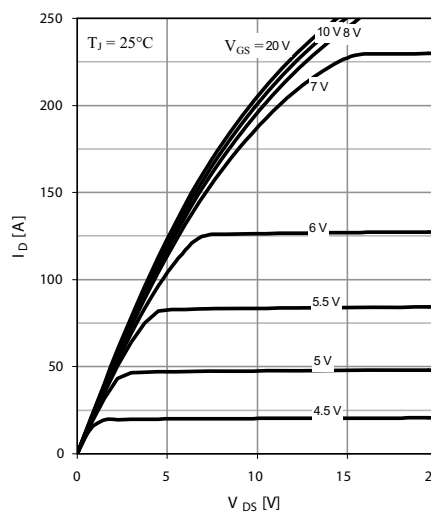

Fig. 2 Typ. output characteristics

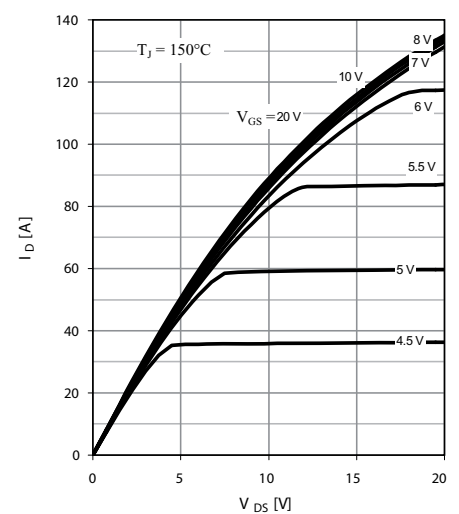

Fig. 3 Typ. output characteristics

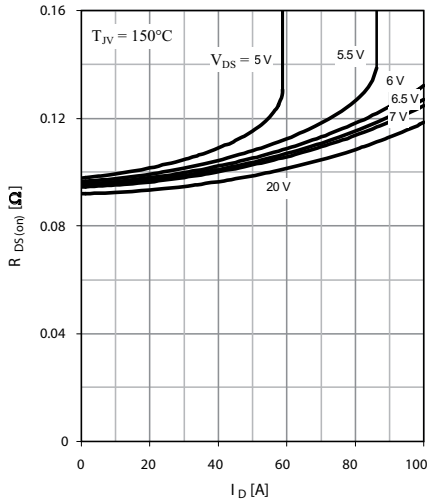

Fig. 4 Typ. drain-source on-state resistance characteristics of IGBT

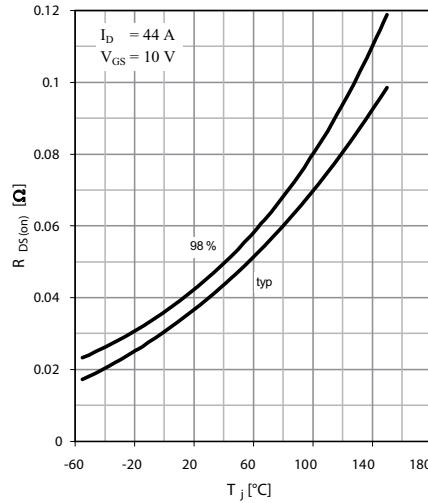

Fig. 5 Drain-source on-state resistance

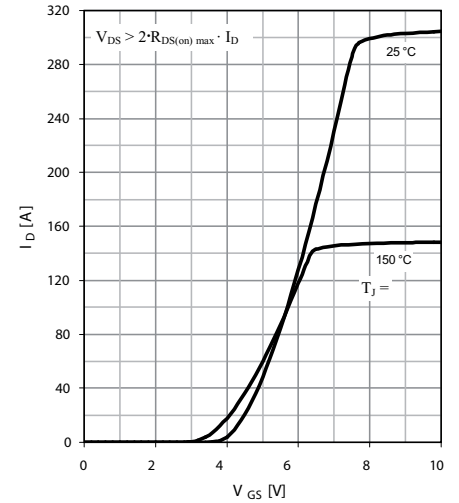

Fig. 6 Typ. transfer characteristics

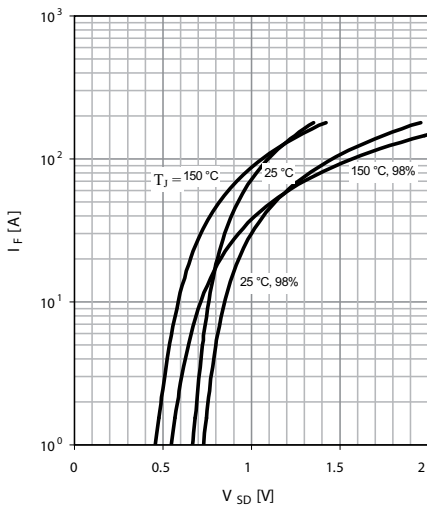

Fig. 7 Forward characteristic of reverse diode

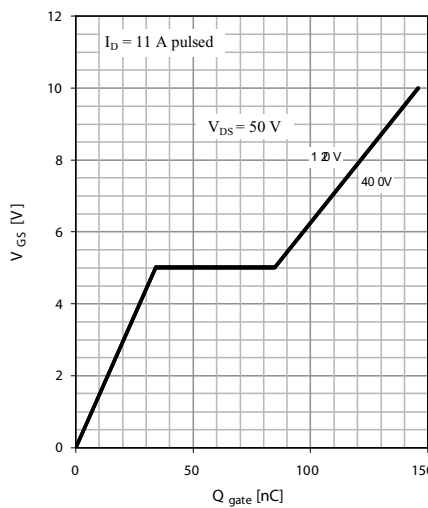

Fig. 8 Typ. gate charge

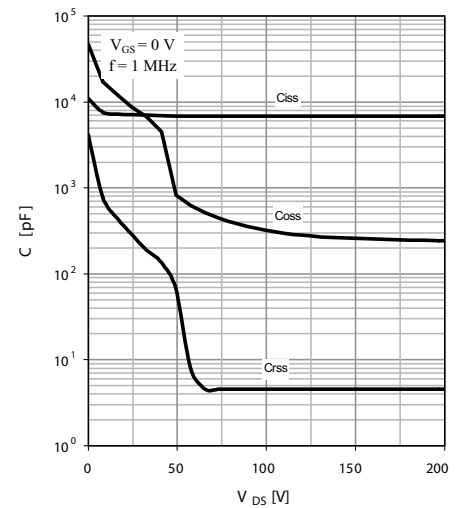

Fig. 9 Typ. capacitances

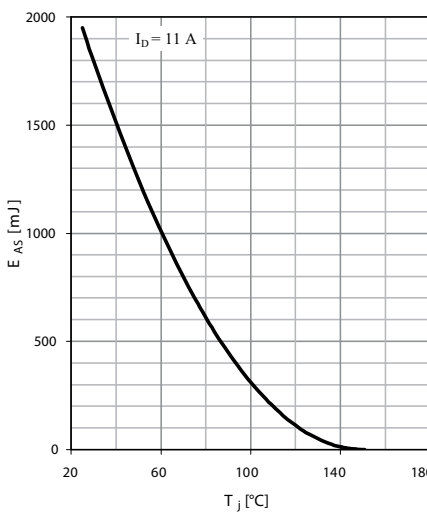

Fig. 10 Avalanche energy

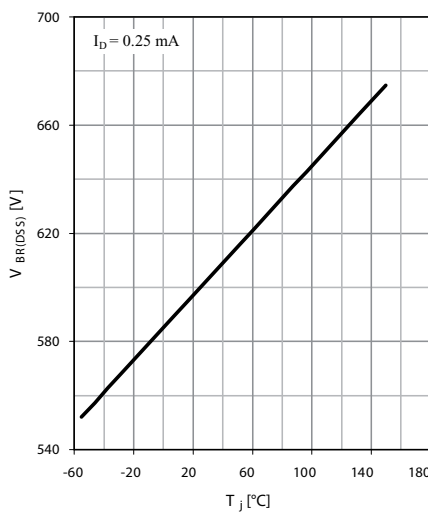

Fig. 11 Drain-source breakdown voltage

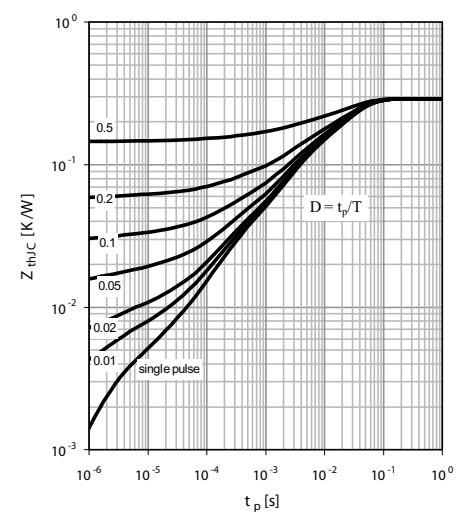

Fig. 12 Max. transient thermal impedance

IXYS reserves the right to change limits, test conditions and dimensions.

20090209d



Disclaimer Notice - Information furnished is believed to be accurate and reliable. However, users should independently evaluate the suitability of and test each product selected for their own applications. Littelfuse products are not designed for, and may not be used in, all applications. Read complete Disclaimer Notice at www.littelfuse.com/disclaimer-electronics.