

**TrenchT2™ HiPerFET™  
Power MOSFET**

**IXFH340N075T2  
IXFT340N075T2**

**V<sub>DSS</sub> = 75V**  
**I<sub>D25</sub> = 340A**  
**R<sub>DS(on)</sub> ≤ 3.2mΩ**

N-Channel Enhancement Mode  
 Avalanche Rated  
 Fast Intrinsic Diode

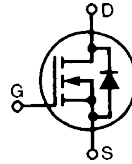

**TO-268  
(IXFT)**

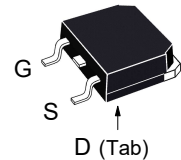

**TO-247  
(IXFH)**

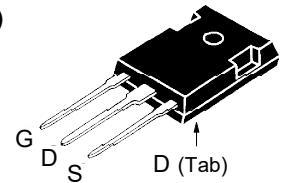

G = Gate      D = Drain  
 S = Source    Tab = Drain

Symbol	Test Conditions	Maximum Ratings	
V <sub>DSS</sub>	T <sub>J</sub> = 25°C to 175°C	75	V
V <sub>DGR</sub>	T <sub>J</sub> = 25°C to 175°C, R <sub>GS</sub> = 1MΩ	75	V
V <sub>GSM</sub>	Transient	± 20	V
I <sub>D25</sub>	T <sub>C</sub> = 25°C (Chip Capability)	340	A
I <sub>LRMS</sub>	Lead Current Limit, RMS	160	A
I <sub>DM</sub>	T <sub>C</sub> = 25°C, Pulse Width Limited by T <sub>JM</sub>	850	A
I <sub>A</sub>	T <sub>C</sub> = 25°C	170	A
E <sub>AS</sub>	T <sub>C</sub> = 25°C	960	mJ
P <sub>D</sub>	T <sub>C</sub> = 25°C	935	W
T <sub>J</sub>		-55 ... +175	°C
T <sub>JM</sub>		175	°C
T <sub>stg</sub>		-55 ... +175	°C
T <sub>L</sub>	Maximum Lead Temperature for Soldering	300	°C
T <sub>SOLD</sub>	Plastic Body for 10 seconds	260	°C
M <sub>d</sub>	Mounting Torque (TO-247)	1.13/10	Nm/lb.in.
Weight	TO-247	6	g
	TO-268	4	g

**Features**

- International Standard Packages
- 175°C Operating Temperature
- High Current Handling Capability
- Avalanche Rated
- Fast Intrinsic Diode
- Low R<sub>DS(on)</sub>

**Advantages**

- Easy to Mount
- Space Savings
- High Power Density

**Applications**

- DC/DC Converters and Off-line UPS
- Primary- Side Switch
- High Current Switching Applications

Symbol	Test Conditions (T <sub>J</sub> = 25°C Unless Otherwise Specified)	Characteristic Values		
		Min.	Typ.	Max.
BV <sub>DSS</sub>	V <sub>GS</sub> = 0V, I <sub>D</sub> = 1mA	75		V
V <sub>GS(th)</sub>	V <sub>DS</sub> = V <sub>GS</sub> , I <sub>D</sub> = 3mA	2.0		4.0 V
I <sub>GSS</sub>	V <sub>GS</sub> = ± 20V, V <sub>DS</sub> = 0V			±200 nA
I <sub>DSS</sub>	V <sub>DS</sub> = V <sub>DSS</sub> , V <sub>GS</sub> = 0V  T <sub>J</sub> = 150°C			25 μA
				1.5 mA
R <sub>DS(on)</sub>	V <sub>GS</sub> = 10V, I <sub>D</sub> = 100A, Note 1			3.2 mΩ

Symbol	Test Conditions ( $T_J = 25^\circ\text{C}$ , Unless Otherwise Specified)	Characteristic Values		
		Min.	Typ.	Max.
$g_{fs}$	$V_{DS} = 10\text{V}$ , $I_D = 60\text{A}$ , Note 1	65	110	S
$C_{iss}$	} $V_{GS} = 0\text{V}$ , $V_{DS} = 25\text{V}$ , $f = 1\text{MHz}$		19	nF
$C_{oss}$			2230	pF
$C_{rss}$			490	pF
$R_{Gi}$	Gate Input Resistance		1.7	$\Omega$
$t_{d(on)}$	} <b>Resistive Switching Times</b> $V_{GS} = 10\text{V}$ , $V_{DS} = 0.5 \cdot V_{DSS}$ , $I_D = 100\text{A}$ $R_G = 1\Omega$ (External)		26	ns
$t_r$			50	ns
$t_{d(off)}$			60	ns
$t_f$			35	ns
$Q_{g(on)}$	} $V_{GS} = 10\text{V}$ , $V_{DS} = 0.5 \cdot V_{DSS}$ , $I_D = 0.5 \cdot I_{D25}$		300	nC
$Q_{gs}$			68	nC
$Q_{gd}$			70	nC
$R_{thJC}$				0.16 $^\circ\text{C/W}$
$R_{thCH}$	TO-247		0.21	$^\circ\text{C/W}$

**Source-Drain Diode**

Symbol	Test Conditions ( $T_J = 25^\circ\text{C}$ , Unless Otherwise Specified)	Characteristic Values		
		Min.	Typ.	Max.
$I_S$	$V_{GS} = 0\text{V}$			340 A
$I_{SM}$	Repetitive, Pulse Width Limited by $T_{JM}$			1360 A
$V_{SD}$	$I_F = 100\text{A}$ , $V_{GS} = 0\text{V}$ , Note 1			1.3 V
$t_{rr}$	} $I_F = 170\text{A}$ , $V_{GS} = 0\text{V}$ $-di/dt = 100\text{A}/\mu\text{s}$ $V_R = 37.5\text{V}$		75	ns
$I_{RM}$			4.4	A
$Q_{RM}$			165	nC

Note 1. Pulse test,  $t \leq 300\mu\text{s}$ ; duty cycle,  $d \leq 2\%$ .

Littelfuse reserves the right to change limits, test conditions, and dimensions.

IXYS MOSFETs and IGBTs are covered by one or more of the following U.S. patents:	4,835,592	4,931,844	5,049,961	5,237,481	6,162,665	6,404,065 B1	6,683,344	6,727,585	7,005,734 B2	7,157,338B2
	4,860,072	5,017,508	5,063,307	5,381,025	6,259,123B1	6,534,343	6,710,405B2	6,759,692	7,063,975B2	
	4,881,106	5,034,796	5,187,117	5,486,715	6,306,728 B1	6,583,505	6,710,463	6,771,478 B2	7,071,537	

**Fig. 1. Output Characteristics @  $T_J = 25^\circ\text{C}$**

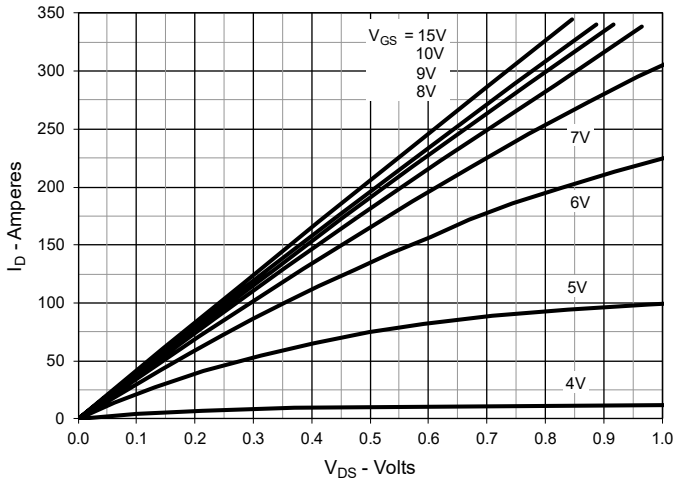

**Fig. 2. Extended Output Characteristics @  $T_J = 25^\circ\text{C}$**

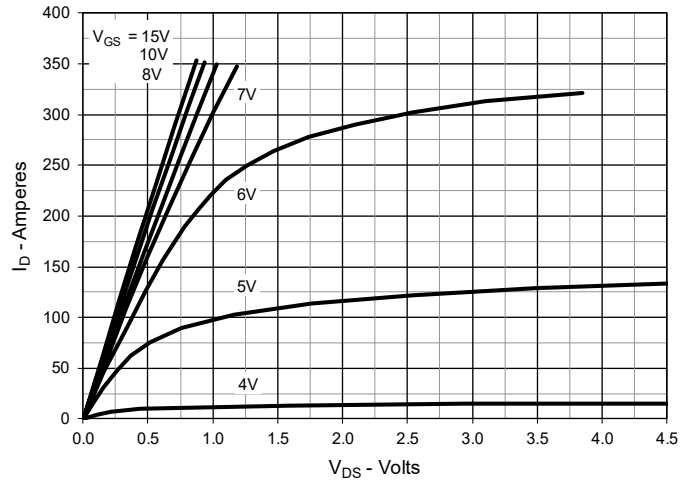

**Fig. 3. Output Characteristics @  $T_J = 150^\circ\text{C}$**

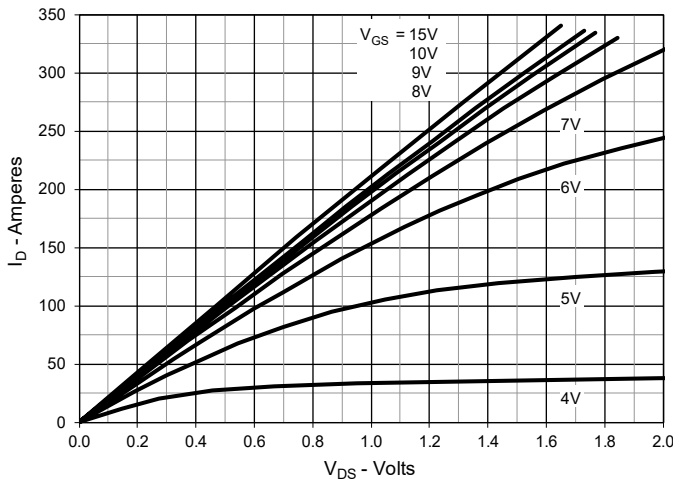

**Fig. 4.  $R_{DS(on)}$  Normalized to  $I_D = 170\text{A}$  Value vs. Junction Temperature**

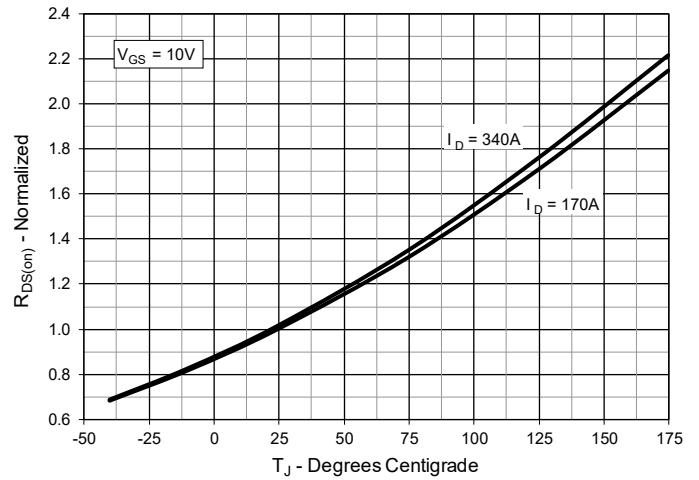

**Fig. 5.  $R_{DS(on)}$  Normalized to  $I_D = 170\text{A}$  Value vs. Drain Current**

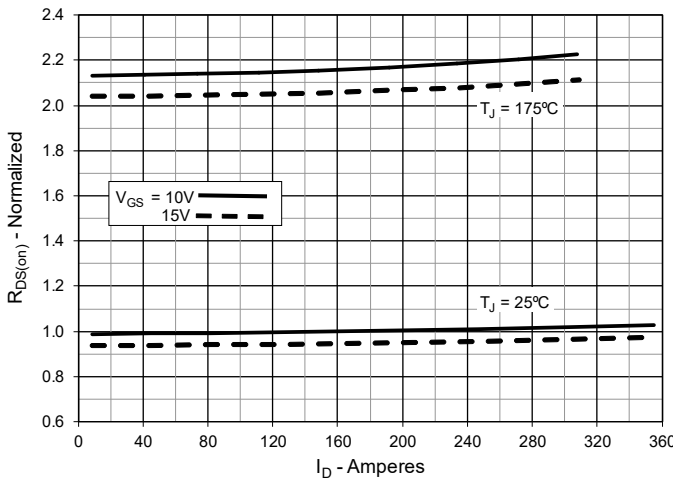

**Fig. 6. Drain Current vs. Case Temperature**

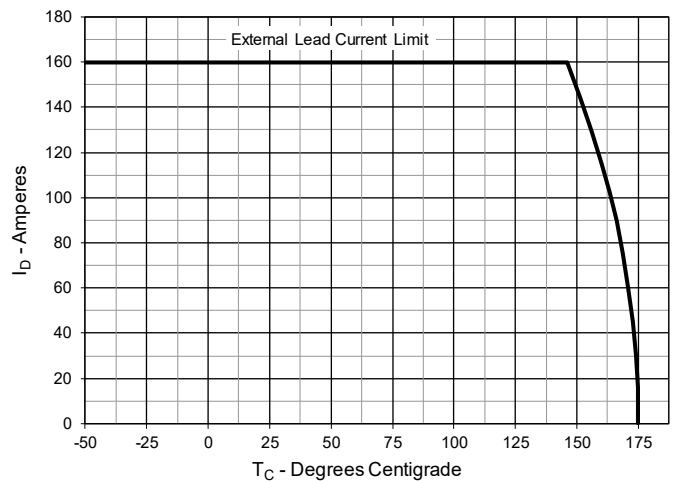

**Fig. 7. Input Admittance**

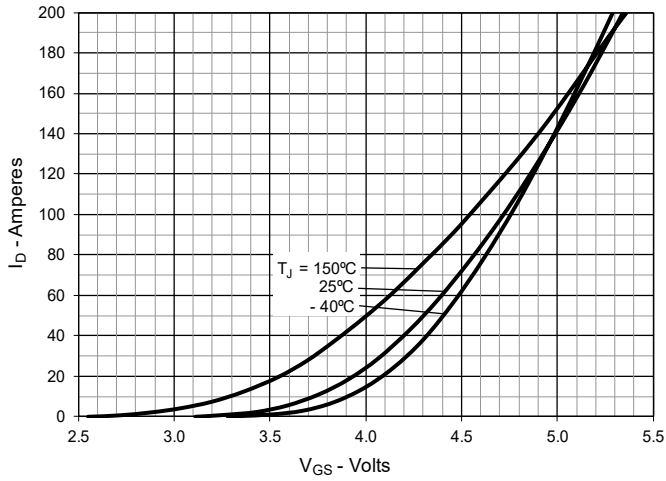

**Fig. 8. Transconductance**

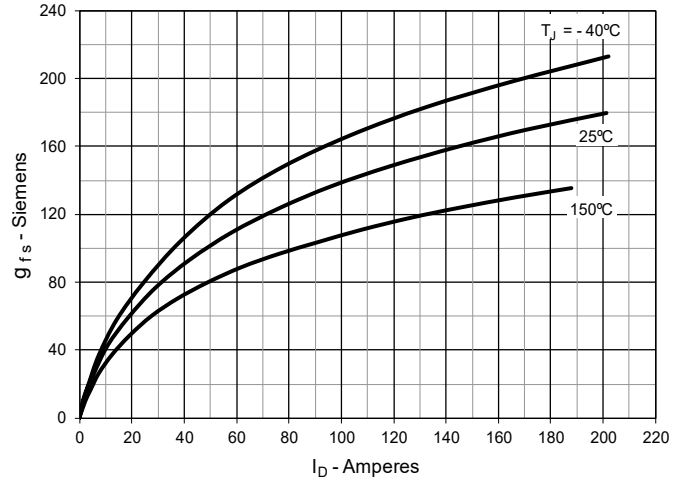

**Fig. 9. Forward Voltage Drop of Intrinsic Diode**

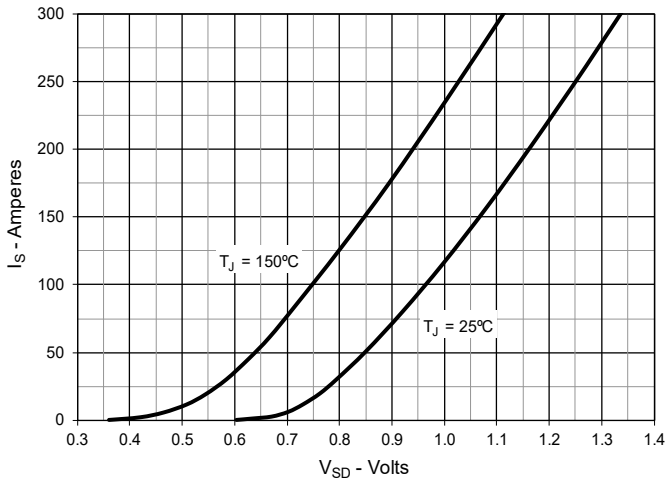

**Fig. 10. Gate Charge**

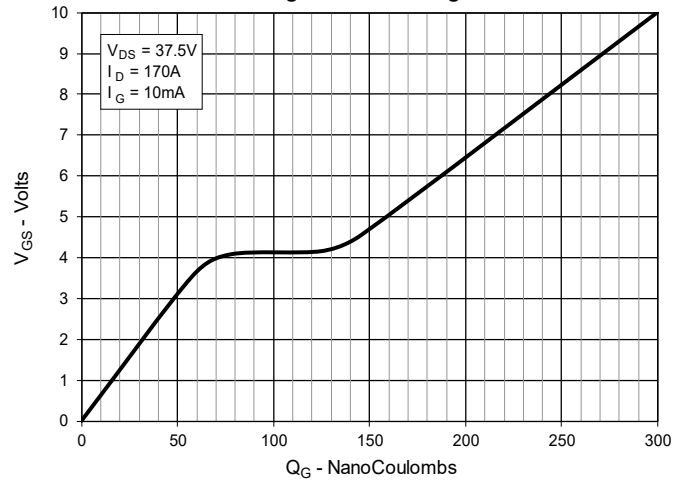

**Fig. 11. Capacitance**

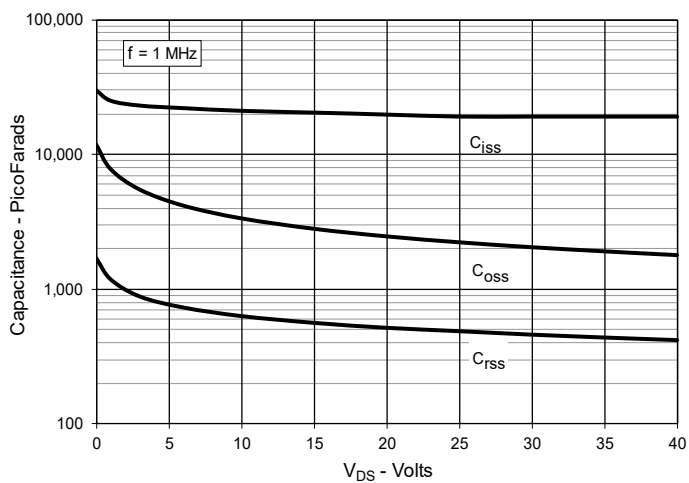

**Fig. 12. Forward-Bias Safe Operating Area**

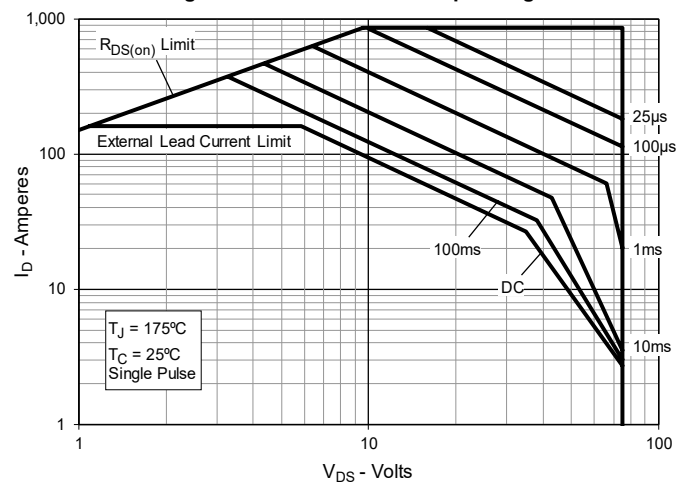

**Fig. 13. Resistive Turn-on Rise Time vs. Junction Temperature**

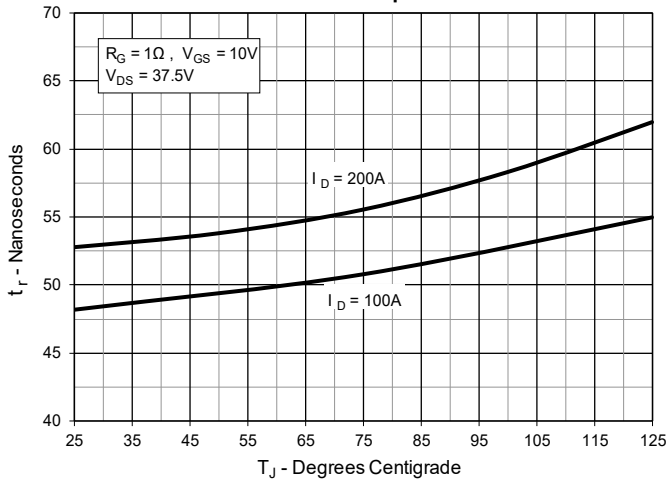

**Fig. 14. Resistive Turn-on Rise Time vs. Drain Current**

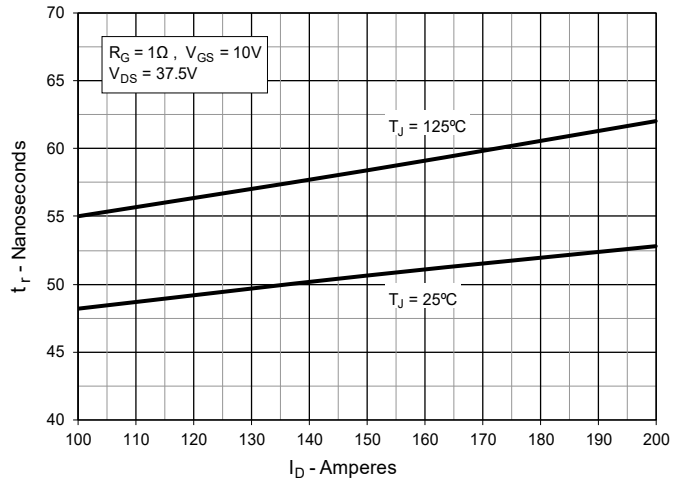

**Fig. 15. Resistive Turn-on Switching Times vs. Gate Resistance**

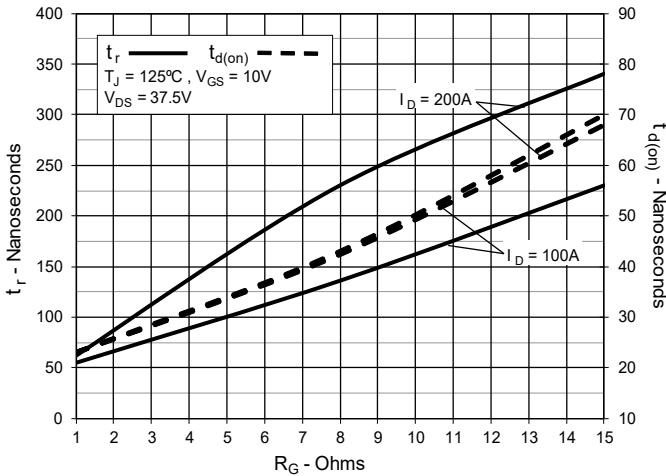

**Fig. 16. Resistive Turn-off Switching Times vs. Junction Temperature**

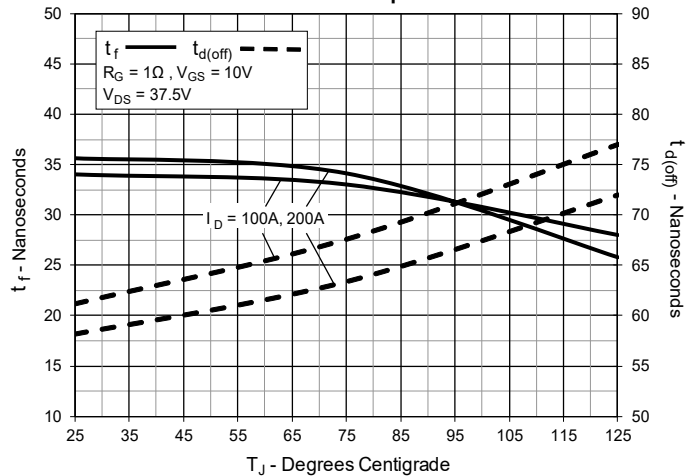

**Fig. 17. Resistive Turn-off Switching Times vs. Drain Current**

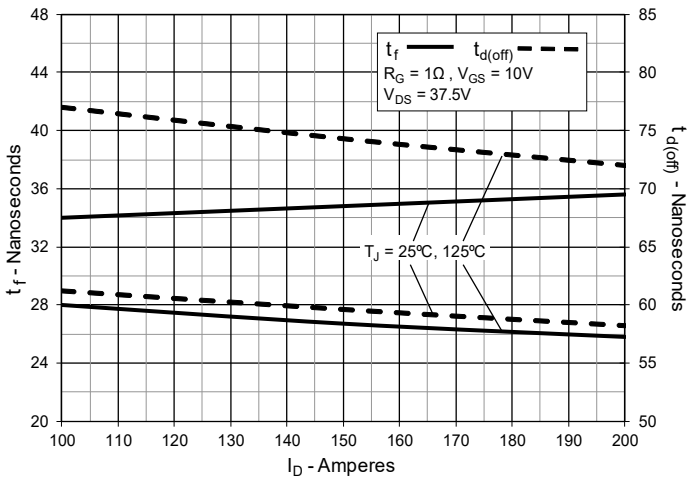

**Fig. 18. Resistive Turn-off Switching Times vs. Gate Resistance**

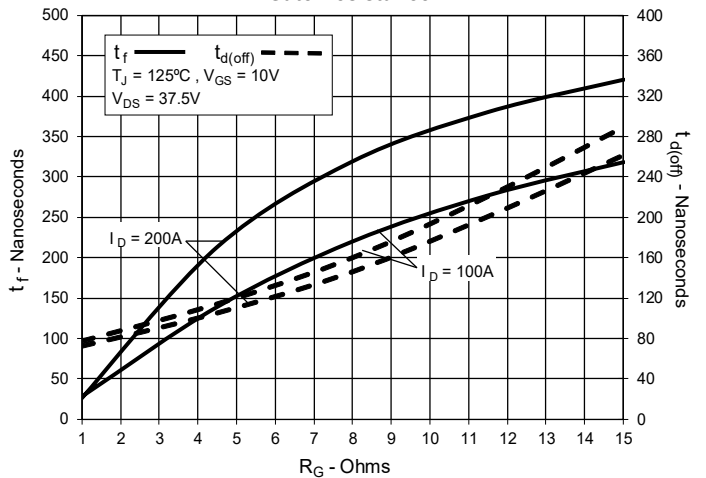
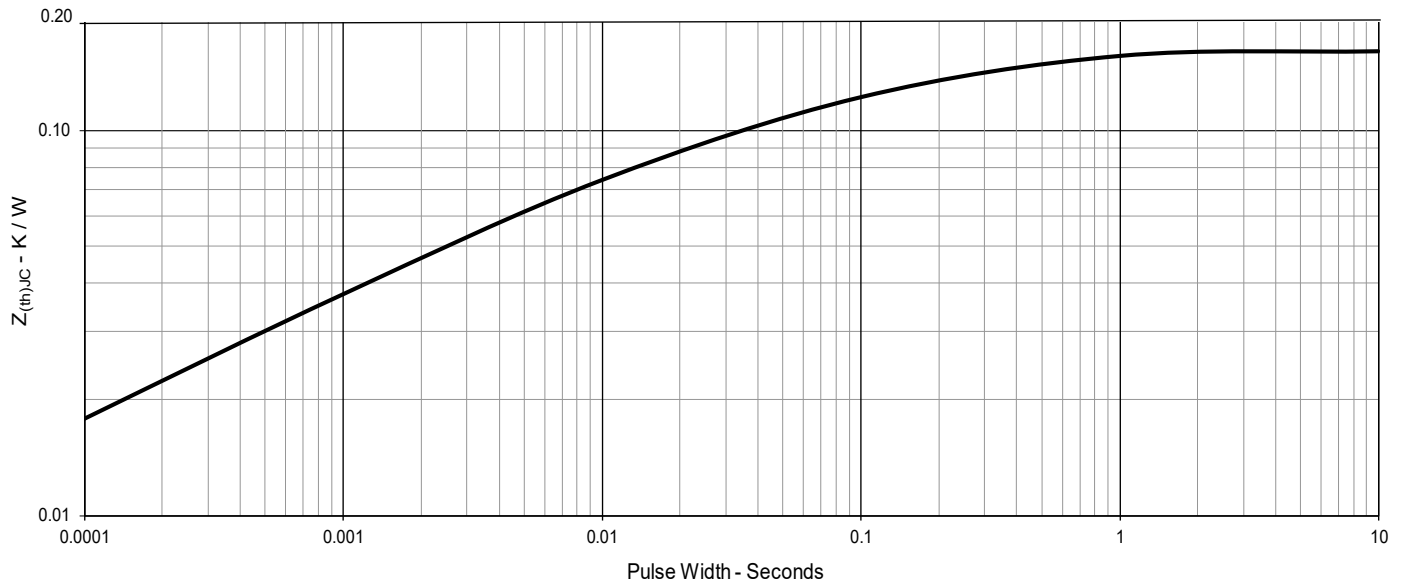
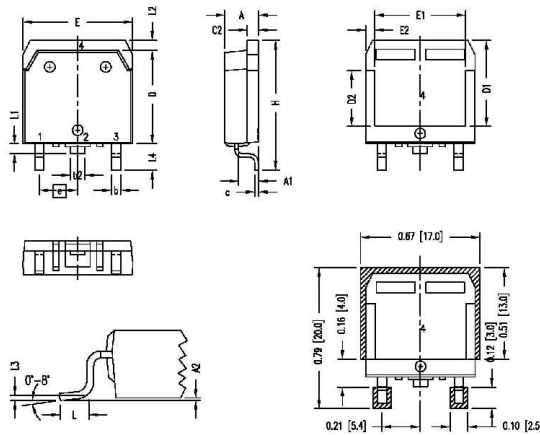

Fig. 19. Maximum Transient Thermal Impedance



### TO-268 Outline



1 - Gate  
2,4 - Drain  
3 - Source

RECOMMENDED MINIMUM FOOT PRINT FOR SMD

SYMBOL	INCHES		MILLIMETERS	
	MIN	MAX	MIN	MAX
A	.193	.201	4.90	5.10
A1	.106	.114	2.70	2.90
A2	.001	.010	0.02	0.25
b	.045	.057	1.15	1.45
b2	.075	.083	1.90	2.10
C	.016	.026	0.40	0.65
C2	.057	.063	1.45	1.60
D	.543	.551	13.80	14.00
D1	.488	.500	12.40	12.70
D2	.320	.335	8.13	8.50
E	.624	.632	15.85	16.05
E1	.524	.535	13.30	13.60
E2	.045	.055	1.14	1.39
e	.215 BSC		5.45 BSC	
H	.736	.752	18.70	19.10
L	.094	.106	2.40	2.70
L1	.047	.055	1.20	1.40
L2	.039	.045	1.00	1.15
L3	.010 BSC		0.25 BSC	
L4	.150	.161	3.80	4.10

NOTE: ALL METAL SURFACE ARE MATTE PURE TIN PLATED EXCEPT TRIM AREA.  
Pb PLATING THICKNESS (4 - 20 um)

### TO-247 Outline

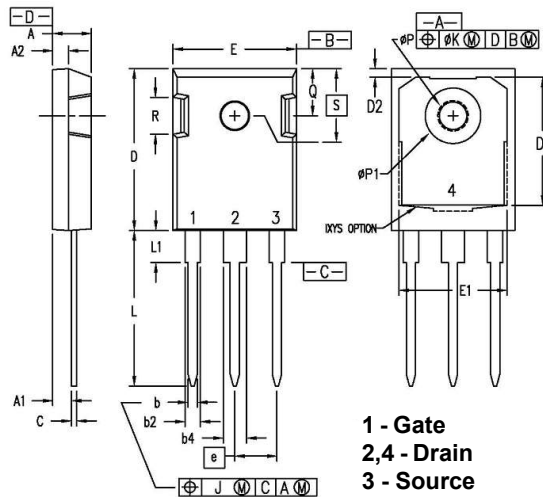

1 - Gate  
2,4 - Drain  
3 - Source

SYM	INCHES		MILLIMETERS	
	MIN	MAX	MIN	MAX
A	.190	.205	4.83	5.21
A1	.090	.100	2.29	2.54
A2	.075	.085	1.91	2.16
b	.045	.055	1.14	1.40
b2	.075	.087	1.91	2.20
b4	.115	.126	2.92	3.20
C	.024	.031	0.61	0.80
D	.819	.840	20.80	21.34
D1	.650	.690	16.51	17.53
D2	.035	.050	0.89	1.27
E	.620	.635	15.75	16.13
E1	.545	.565	13.84	14.35
e	.215 BSC		5.45 BSC	
J	--	.010	--	0.25
K	--	.025	--	0.64
L	.780	.810	19.81	20.57
L1	.150	.170	3.81	4.32
øP	.140	.144	3.55	3.65
øP1	.275	.290	6.99	7.37
Q	.220	.244	5.59	6.20
R	.170	.190	4.32	4.83
S		.242 BSC		6.15 BSC

NOTE: This drawing will meet all dimensions requirement of JEDEC outlines TO-247 AD (R-PSIP-F3)