

TrenchT2™ HiperFET™ Power MOSFET

IXFA76N15T2
IXFP76N15T2
IXFH76N15T2

V_{DSS} = 150V
I_{D25} = 76A
R_{DS(on)} ≤ 22mΩ

N-Channel Enhancement Mode
Avalanche Rated
Fast Intrinsic Rectifier

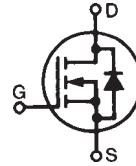

Symbol	Test Conditions	Maximum Ratings	
V _{DSS}	T _J = 25°C to 175°C	150	V
V _{DGR}	T _J = 25°C to 175°C, R _{GS} = 1MΩ	150	V
V _{GSS}	Continuous	± 20	V
V _{GSM}	Transient	± 30	V
I _{D25}	T _C = 25°C	76	A
I _{DM}	T _C = 25°C, Pulse Width Limited by T _{JM}	200	A
I _A	T _C = 25°C	38	A
E _{AS}	T _C = 25°C	500	mJ
dv/dt	I _S ≤ I _{DM} , V _{DD} ≤ V _{DSS} , T _J ≤ 175°C	15	V/ns
P _D	T _C = 25°C	350	W
T _J		-55 ... +175	°C
T _{JM}		175	°C
T _{stg}		-55 ... +175	°C
T _L	Maximum Lead Temperature for Soldering	300	°C
T _{SOLD}	Plastic Body for 10s	260	°C
F _C	Mounting Force (TO-263)	10..65 / 2.2..14.6	N/lb
M _d	Mounting Torque (TO-220 & TO-247)	1.13 / 10	Nm/lb.in
Weight	TO-263	2.5	g
	TO-220	3.0	g
	TO-247	6.0	g

Symbol	Test Conditions (T _J = 25°C Unless Otherwise Specified)	Characteristic Values		
		Min.	Typ.	Max.
BV _{DSS}	V _{GS} = 0V, I _D = 250μA	150		V
V _{GS(th)}	V _{DS} = V _{GS} , I _D = 250μA	2.5		4.5 V
I _{GSS}	V _{GS} = ± 20V, V _{DS} = 0V			±200 nA
I _{DSS}	V _{DS} = V _{DSS} , V _{GS} = 0V T _J = 150°C			5 μA
				750 μA
R _{DS(on)}	V _{GS} = 10V, I _D = 0.5 • I _{D25} , Notes 1, 2			22 mΩ

TO-263
(IXFA)

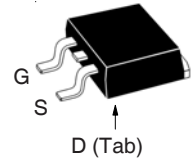

TO-220
(IXFP)

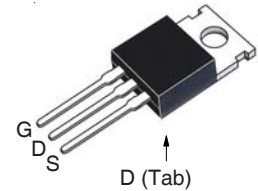

TO-247
(IXFH)

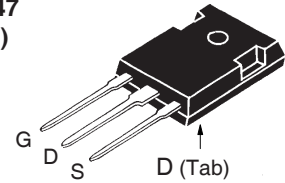

G = Gate D = Drain
S = Source Tab = Drain

Features

- International Standard Packages
- 175°C Operating Temperature
- High Current Handling Capability
- Fast Intrinsic Rectifier
- Dynamic dv/dt Rated
- Low R_{DS(on)}

Advantages

- Easy to Mount
- Space Savings
- High Power Density

Applications

- DC-DC Converters
- Battery Chargers
- Switch-Mode and Resonant-Mode Power Supplies
- DC Choppers
- AC Motor Drives
- Uninterruptible Power Supplies
- High Speed Power Switching Applications

Symbol	Test Conditions ($T_J = 25^\circ\text{C}$, Unless Otherwise Specified)	Characteristic Values		
		Min.	Typ.	Max.
g_{fs}	$V_{DS} = 10\text{V}$, $I_D = 0.5 \cdot I_{D25}$, Note 1	50	80	S
C_{iss}	$V_{GS} = 0\text{V}$, $V_{DS} = 25\text{V}$, $f = 1\text{MHz}$		5800	pF
C_{oss}			490	pF
C_{rss}			85	pF
$t_{d(on)}$	Resistive Switching Times $V_{GS} = 10\text{V}$, $V_{DS} = 0.5 \cdot V_{DSS}$, $I_D = 0.5 \cdot I_{D25}$ $R_G = 5\Omega$ (External)		17	ns
t_r			19	ns
$t_{d(off)}$			25	ns
t_f			14	ns
$Q_{g(on)}$	$V_{GS} = 10\text{V}$, $V_{DS} = 0.5 \cdot V_{DSS}$, $I_D = 0.5 \cdot I_{D25}$		97	nC
Q_{gs}			29	nC
Q_{gd}			30	nC
R_{thJC}				0.43 $^\circ\text{C/W}$
R_{thCS}	TO-220		0.50	$^\circ\text{C/W}$
	TO-247		0.21	$^\circ\text{C/W}$

Source-Drain Diode

Symbol	Test Conditions ($T_J = 25^\circ\text{C}$, Unless Otherwise Specified)	Characteristic Values		
		Min.	Typ.	Max.
I_S	$V_{GS} = 0\text{V}$			76 A
I_{SM}	Repetitive, Pulse Width Limited by T_{JM}			300 A
V_{SD}	$I_F = 38\text{A}$, $V_{GS} = 0\text{V}$, Note 1			1.5 V
t_{rr}	$I_F = 38\text{A}$, $V_{GS} = 0\text{V}$ $-di/dt = 100\text{A}/\mu\text{s}$ $V_R = 75\text{V}$		69	ns
I_{RM}			5.7	A
Q_{RM}			197	nC

- Notes: 1. Pulse test, $t \leq 300\mu\text{s}$, duty cycle, $d \leq 2\%$.
2. On through-hole packages, $R_{DS(on)}$ Kelvin test contact location must be 5mm or less from the package body.

IXYS Reserves the Right to Change Limits, Test Conditions, and Dimensions.

Fig. 1. Output Characteristics @ $T_J = 25^\circ\text{C}$

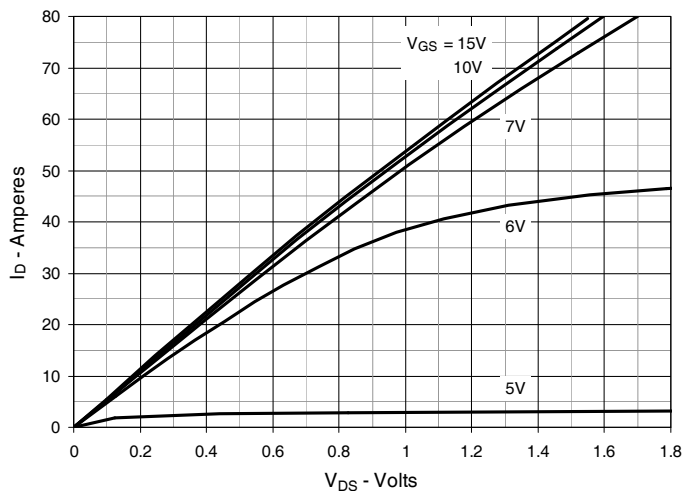

Fig. 2. Extended Output Characteristics @ $T_J = 25^\circ\text{C}$

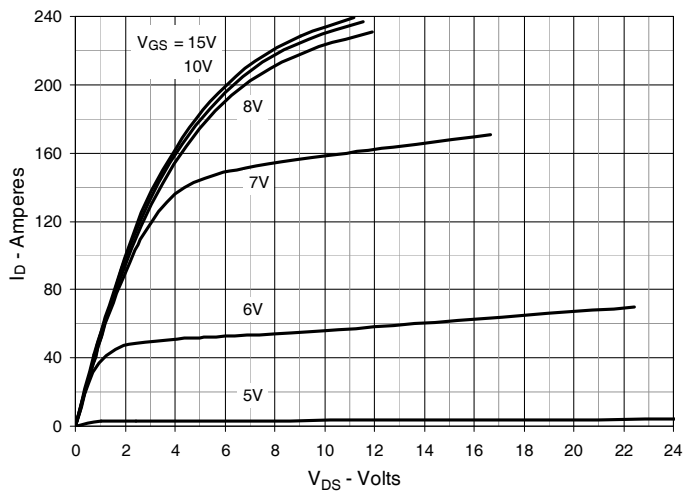

Fig. 3. Output Characteristics @ $T_J = 150^\circ\text{C}$

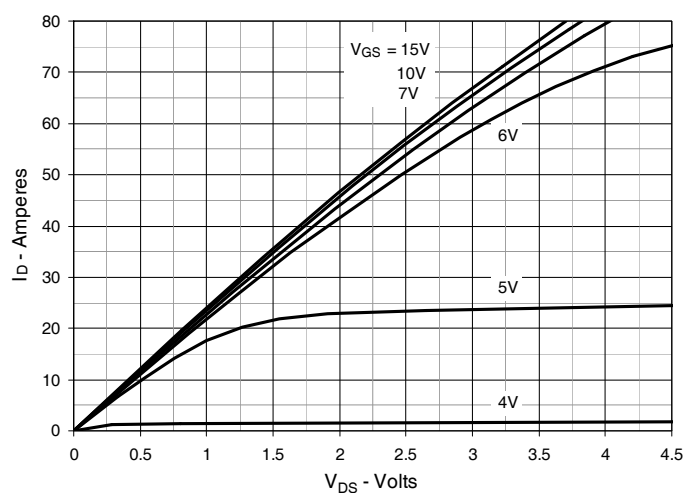

Fig. 4. $R_{DS(on)}$ Normalized to $I_D = 38\text{A}$ Value vs. Junction Temperature

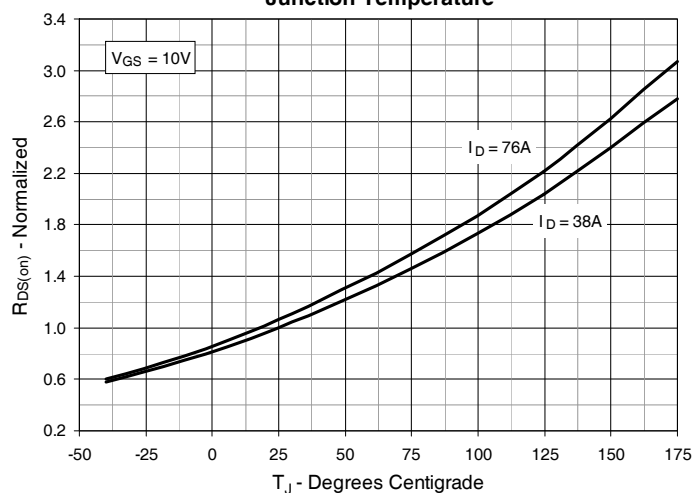

Fig. 5. $R_{DS(on)}$ Normalized to $I_D = 38\text{A}$ Value vs. Drain Current

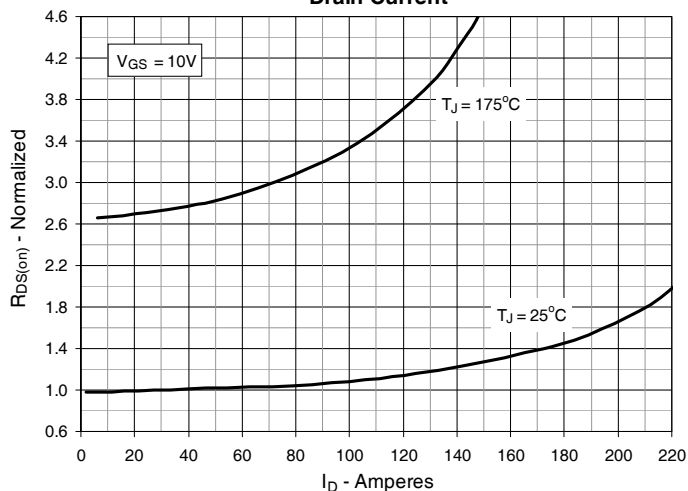

Fig. 6. Drain Current vs. Case Temperature

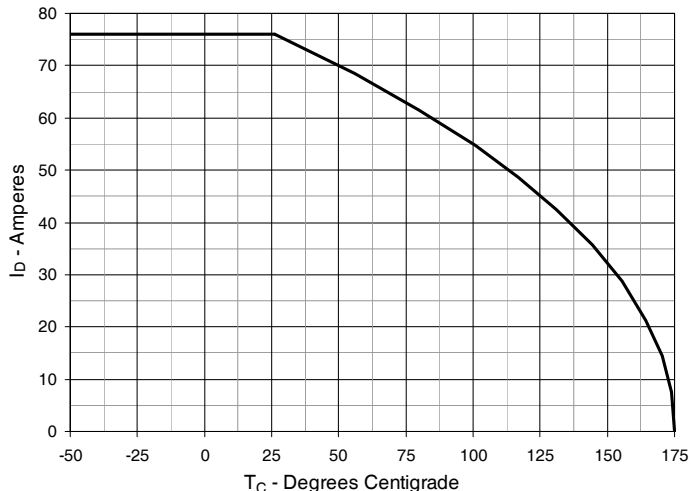

Fig. 7. Input Admittance

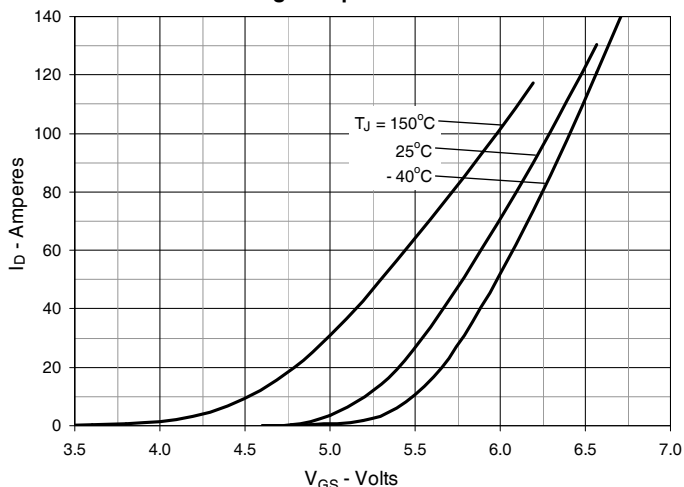

Fig. 8. Transconductance

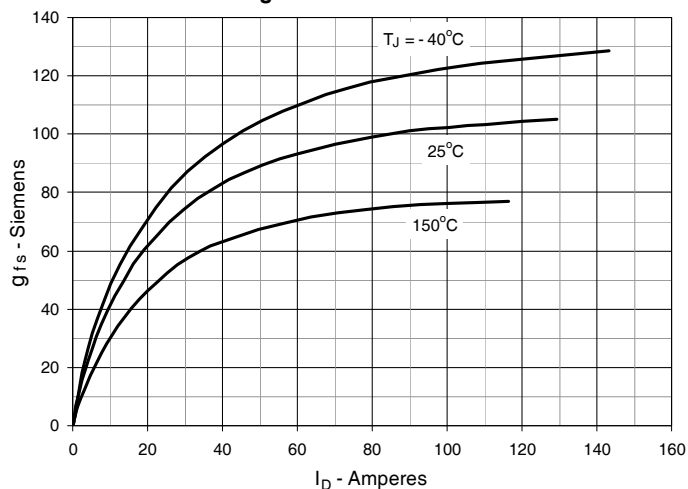

Fig. 9. Forward Voltage Drop of Intrinsic Diode

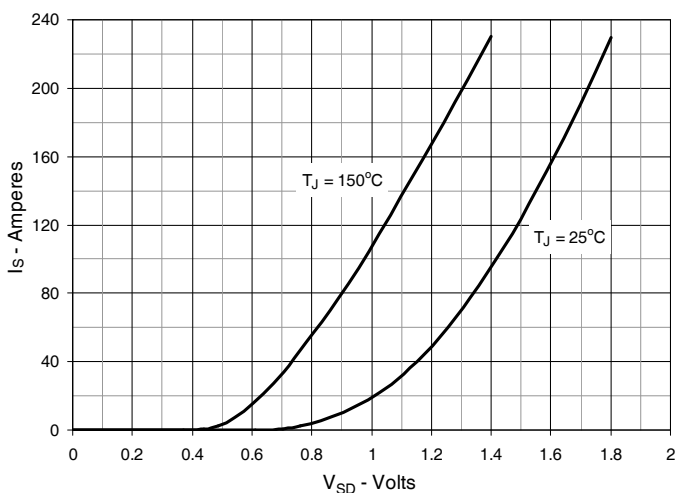

Fig. 10. Gate Charge

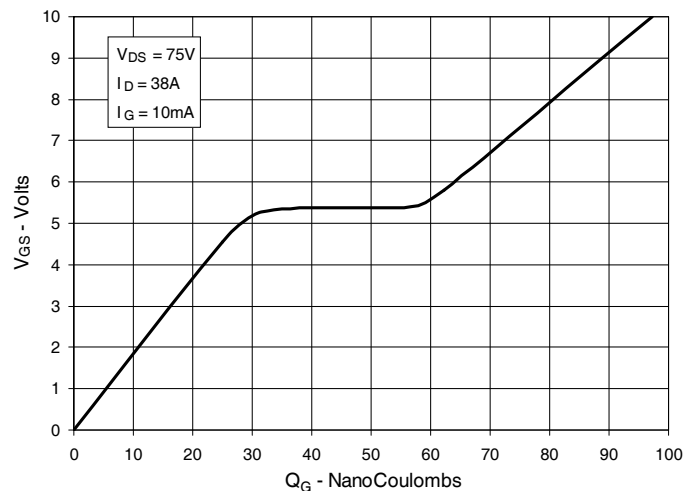

Fig. 11. Capacitance

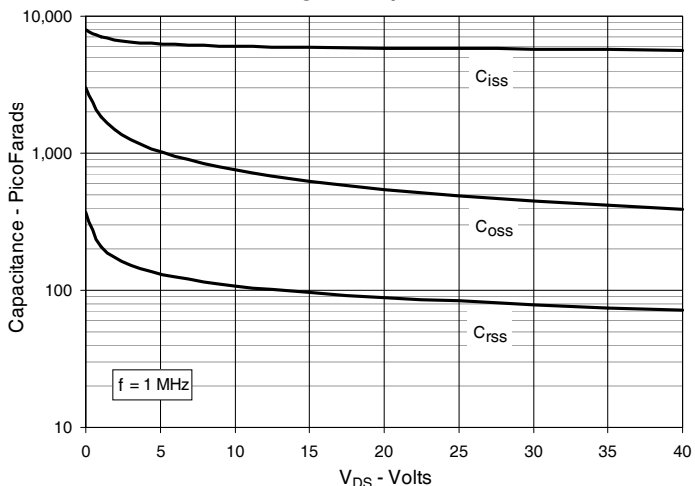

Fig. 12. Forward-Bias Safe Operating Area

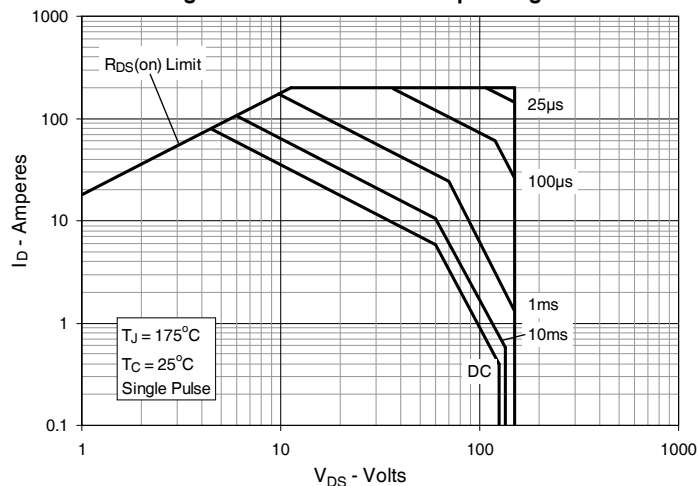

Fig. 13. Resistive Turn-on Rise Time vs. Junction Temperature

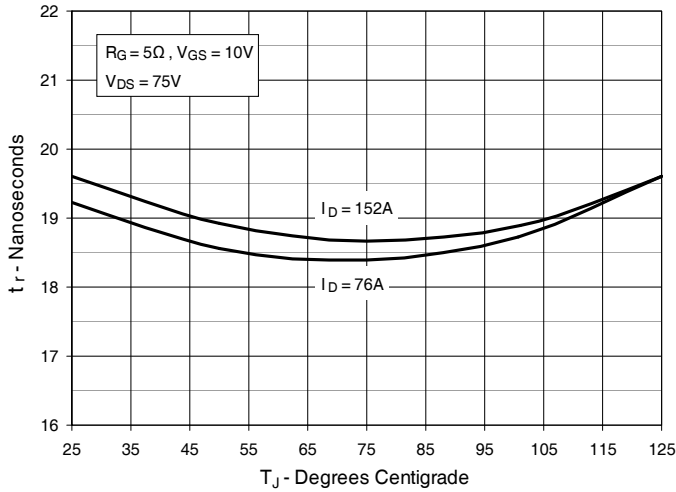

Fig. 14. Resistive Turn-on Rise Time vs. Drain Current

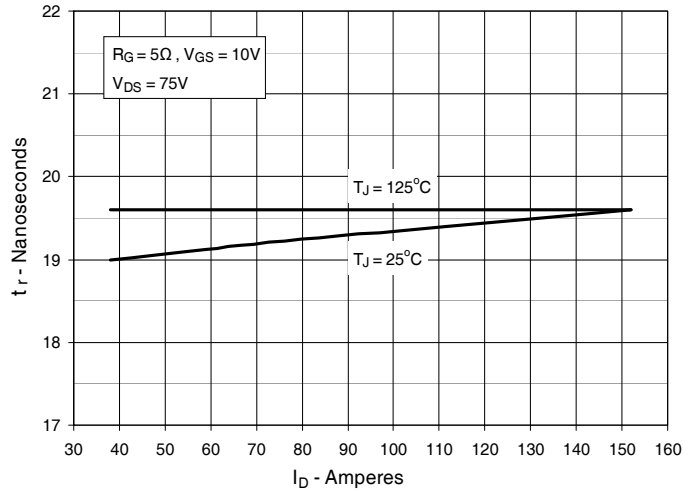

Fig. 15. Resistive Turn-on Switching Times vs. Gate Resistance

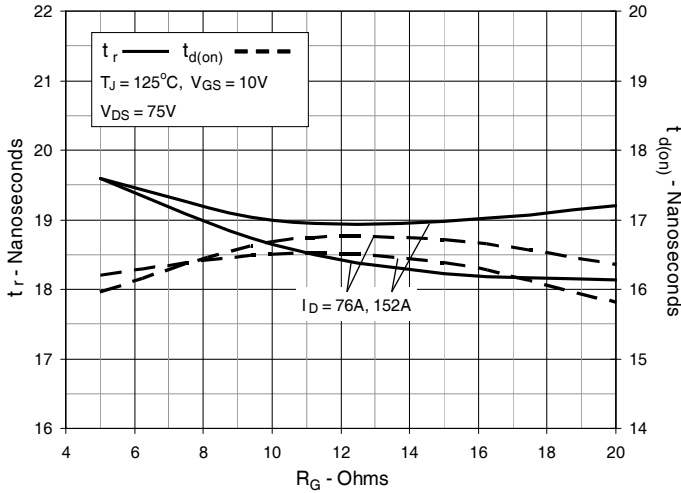

Fig. 16. Resistive Turn-off Switching Times vs. Junction Temperature

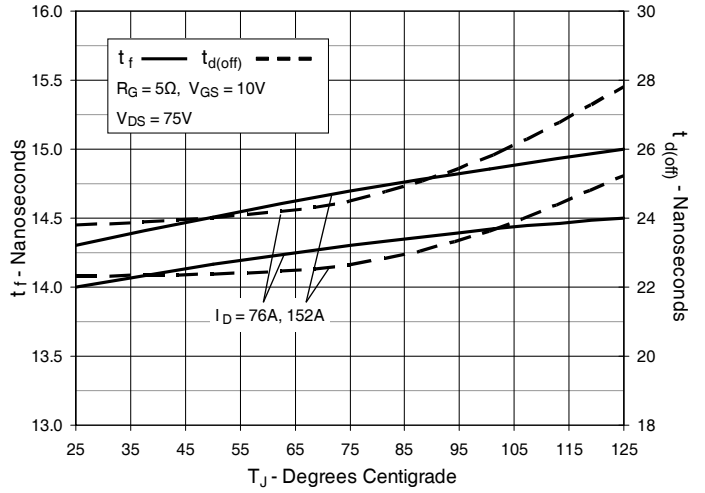

Fig. 17. Resistive Turn-off Switching Times vs. Drain Current

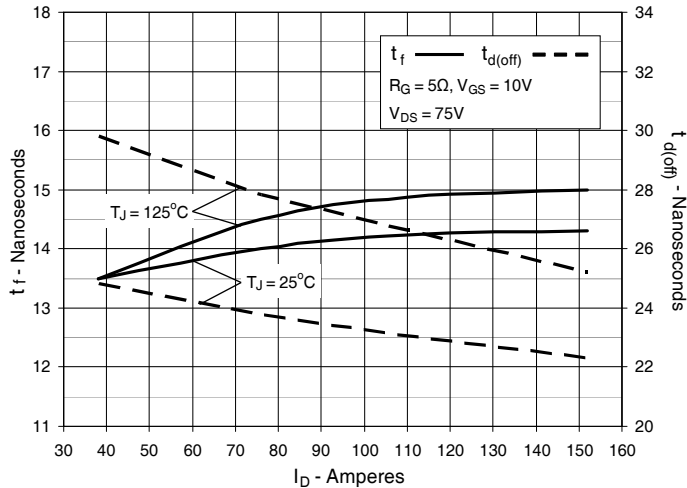

Fig. 18. Resistive Turn-off Switching Times vs. Gate Resistance

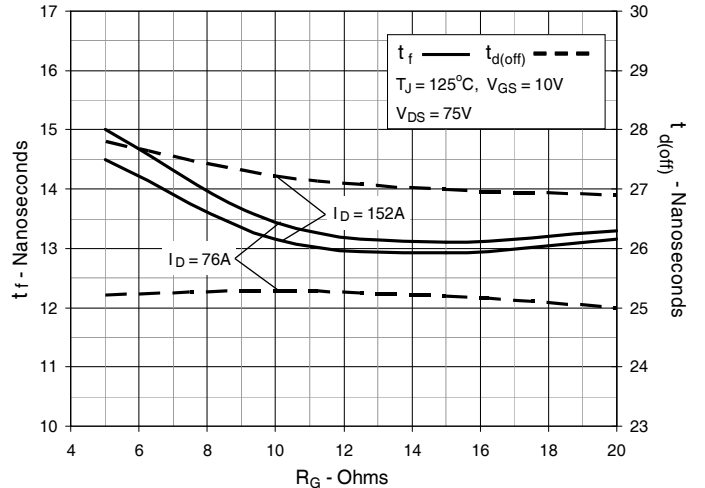
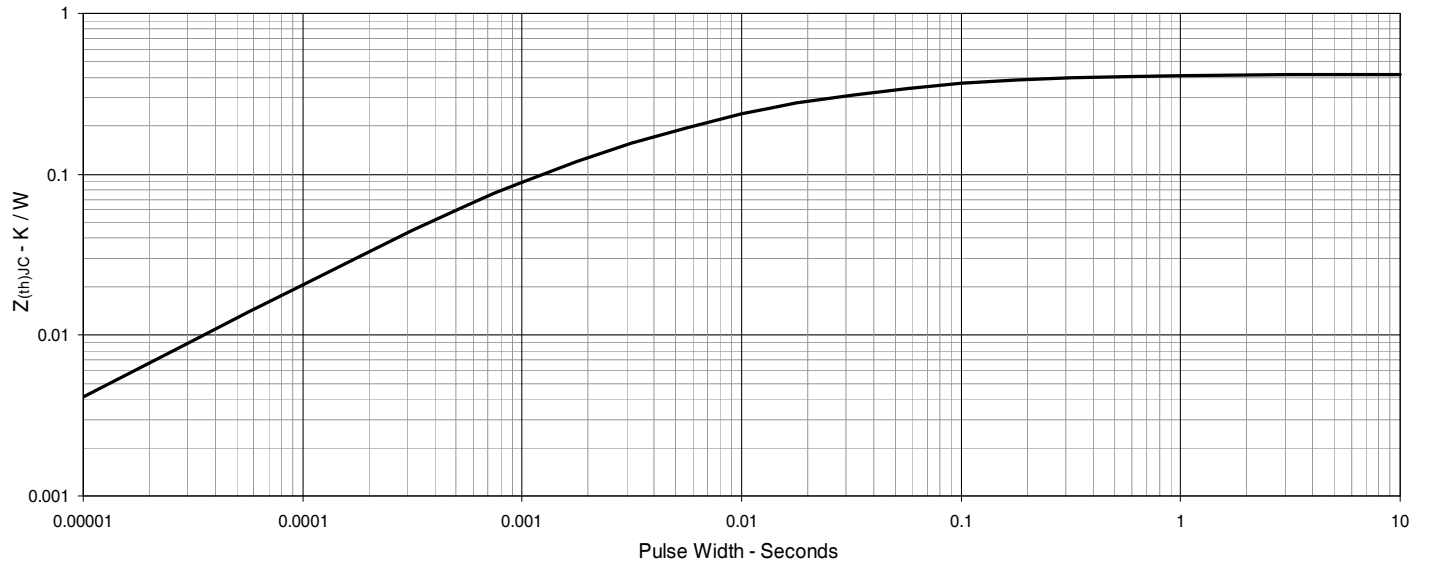
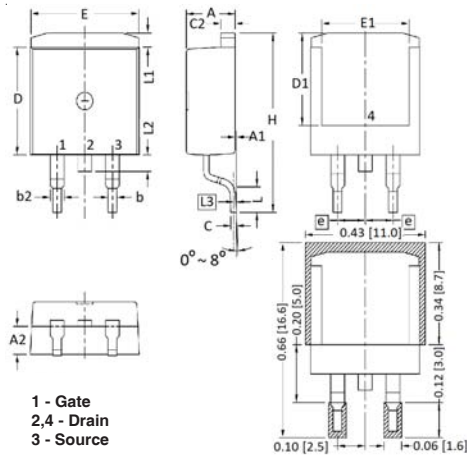

Fig. 19. Maximum Transient Thermal Impedance



TO-263 Outline



SYM	INCHES		MILLIMETER	
	MIN	MAX	MIN	MAX
A	.170	.185	4.30	4.70
A1	.000	.008	0.00	0.20
A2	.091	.098	2.30	2.50
b	.028	.035	0.70	0.90
b2	.046	.060	1.18	1.52
C	.018	.024	0.45	0.60
C2	.049	.060	1.25	1.52
D	.340	.370	8.63	9.40
D1	.300	.327	7.62	8.30
E	.380	.410	9.65	10.41
E1	.270	.330	6.86	8.38
e	.100 BSC		2.54 BSC	
H	.580	.620	14.73	15.75
L	.075	.105	1.91	2.67
L1	.039	.060	1.00	1.52
L2	—	.070	—	1.77
L3	.010 BSC		0.254 BSC	

TO-220 Outline

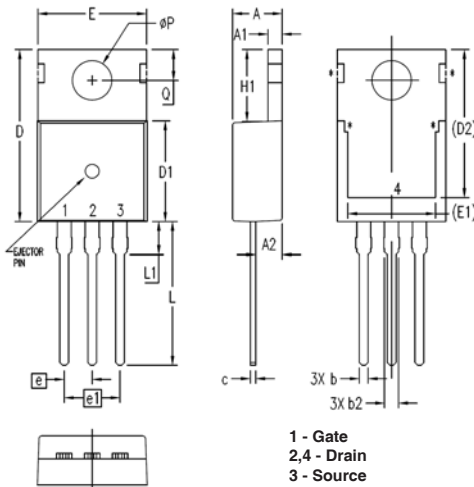

SYM	INCHES		MILLIMETERS	
	MIN	MAX	MIN	MAX
A	.169	.185	4.30	4.70
A1	.047	.055	1.20	1.40
A2	.079	.106	2.00	2.70
b	.024	.039	0.60	1.00
b2	.045	.057	1.15	1.45
c	.014	.026	0.35	0.65
D	.587	.626	14.90	15.90
D1	.335	.370	8.50	9.40
(D2)	.500	.531	12.70	13.50
E	.382	.406	9.70	10.30
(E1)	.283	.323	7.20	8.20
e	.100 BSC		2.54 BSC	
e1	.200 BSC		5.08 BSC	
H1	.244	.268	6.20	6.80
L	.492	.547	12.50	13.90
L1	.110	.154	2.80	3.90
ØP	.134	.150	3.40	3.80
Q	.106	.126	2.70	3.20

TO-247 Outline

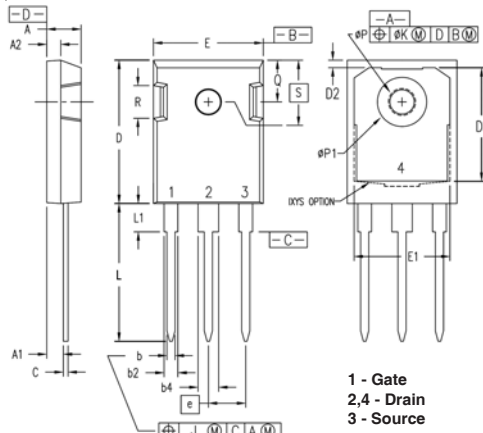

SYM	INCHES		MILLIMETERS	
	MIN	MAX	MIN	MAX
A	.190	.205	4.83	5.21
A1	.090	.100	2.29	2.54
A2	.075	.085	1.91	2.16
b	.045	.055	1.14	1.40
b2	.075	.087	1.91	2.20
b4	.115	.126	2.92	3.20
C	.024	.031	0.61	0.80
D	.819	.840	20.80	21.34
D1	.650	.690	16.51	17.53
D2	.035	.050	0.89	1.27
E	.620	.635	15.75	16.13
E1	.545	.565	13.84	14.35
e	.215 BSC		5.45 BSC	
J	--	.010	--	0.25
K	--	.025	--	0.64
L	.780	.810	19.81	20.57
L1	.150	.170	3.81	4.32
ØP	.140	.144	3.55	3.65
ØP1	.275	.290	6.99	7.37
Q	.220	.244	5.59	6.20
R	.170	.190	4.32	4.83
S	.242 BSC		6.15 BSC	



Disclaimer Notice - Information furnished is believed to be accurate and reliable. However, users should independently evaluate the suitability of and test each product selected for their own applications. Littelfuse products are not designed for, and may not be used in, all applications. Read complete Disclaimer Notice at www.littelfuse.com/disclaimer-electronics.