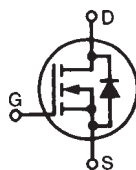

Power MOSFET TrenchHV™ IXFH160N15T
HiPerFET™

 N-Channel Enhancement Mode
 Avalanche Rated

$$V_{DSS} = 150V$$

$$I_{D25} = 160A$$

$$R_{DS(on)} \leq 9.6m\Omega$$

Symbol	Test Conditions	Maximum	Ratings
V_{DSS}	$T_J = 25^\circ C$ to $175^\circ C$	150	V
V_{DGR}	$T_J = 25^\circ C$ to $175^\circ C$, $R_{GS} = 1M\Omega$	150	V
V_{GSM}	Transient	± 30	V
I_{D25}	$T_C = 25^\circ C$	160	A
I_{LRMS}	Lead Current Limit, RMS	75	A
I_{DM}	$T_C = 25^\circ C$, pulse width limited by T_{JM}	430	A
I_A	$T_C = 25^\circ C$	5	A
E_{AS}	$T_C = 25^\circ C$	1	J
dV/dt	$I_S \leq I_{DM}$, $V_{DD} \leq V_{DSS}$, $T_J \leq 175^\circ C$	10	V/ns
P_d	$T_C = 25^\circ C$	830	W
T_J		-55 ... +175	$^\circ C$
T_{JM}		175	$^\circ C$
T_{stg}		-55 ... +175	$^\circ C$
T_L	1.6 mm (0.062 in.) from case for 10s	300	$^\circ C$
T_{SOLD}	Plastic body for 10 seconds	260	$^\circ C$
M_d	Mounting torque	1.13 / 10	Nm/lb.in.
Weight		6	g

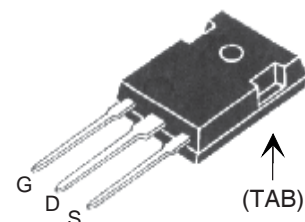
TO-247 (IXFH)

 G = Gate D = Drain
 S = Source TAB = Drain

Features

- Unclamped Inductive Switching (UIS) rated
- Low package inductance
 - easy to drive and to protect
- 175 $^\circ C$ Operating Temperature

Advantages

- Easy to mount
- Space savings
- High power density

Applications

- DC-DC converters
- Battery chargers
- Switched-mode and resonant-mode power supplies
- DC choppers
- AC motor control
- Uninterruptible power supplies
- High speed power switching applications

Symbol	Test Conditions	Characteristic Values		
		Min.	Typ.	Max.
BV_{DSS}	$V_{GS} = 0V$, $I_D = 250\mu A$	150		V
$V_{GS(th)}$	$V_{DS} = V_{GS}$, $I_D = 1mA$	2.5		5.0 V
I_{GSS}	$V_{GS} = \pm 20V$, $V_{DS} = 0V$			± 200 nA
I_{DSS}	$V_{DS} = V_{DSS}$ $V_{GS} = 0V$ $T_J = 150^\circ C$			5 μA 250 μA
$R_{DS(on)}$	$V_{GS} = 10V$, $I_D = 0.5 \cdot I_{D25}$, Note 1	8.0		9.6 m Ω

Symbol	Test Conditions	Characteristic Values		
		Min.	Typ.	Max.
(T _J = 25°C unless otherwise specified)				
g_{fs}	V _{DS} = 10V, I _D = 60A, Note 1	65	105	S
C_{iss}	V _{GS} = 0V, V _{DS} = 25V, f = 1 MHz		8800	pF
C_{oss}			1170	pF
C_{rss}			150	pF
t_{d(on)}	Resistive Switching Times V _{GS} = 10V, V _{DS} = 0.5 • V _{DSS} , I _D = 0.5 • I _{D25} R _G = 2Ω (External)		21	ns
t_r			21	ns
t_{d(off)}			52	ns
t_f			29	ns
Q_{g(on)}	V _{GS} = 10V, V _{DS} = 0.5 • V _{DSS} , I _D = 25A		160	nC
Q_{gs}			43	nC
Q_{gd}			46	nC
R_{thJC}			0.18	°C/W
R_{thCS}		0.25		°C/W

Symbol	Test Conditions	Characteristic Values		
		Min.	Typ.	Max.
(T _J = 25°C, unless otherwise specified)				
I_S	V _{GS} = 0V			160 A
I_{SM}	Repetitive, pulse width limited by T _{JM}			430 A
V_{SD}	I _F = I _S , V _{GS} = 0V, Note 1			1.2 V
t_{rr}	I _F = 80A, -di/dt = 200A/μs V _R = 75V, V _{GS} = 0V		90	160 μs
Q_{RM}			12	A
I_{RM}			0.55	μC

Notes: 1. Pulse test, t ≤ 300μs; duty cycle, d ≤ 2%.

TO-247AD Outline

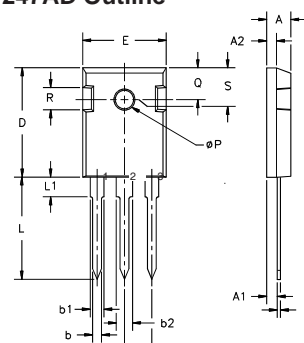

Terminals: 1 - Gate 2 - Drain
3 - Source Tab - Drain

Dim.	Millimeter		Inches	
	Min.	Max.	Min.	Max.
A	4.7	5.3	.185	.209
A ₁	2.2	2.54	.087	.102
A ₂	2.2	2.6	.059	.098
b	1.0	1.4	.040	.055
b ₁	1.65	2.13	.065	.084
b ₂	2.87	3.12	.113	.123
C	.4	.8	.016	.031
D	20.80	21.46	.819	.845
E	15.75	16.26	.610	.640
e	5.20	5.72	0.205	0.225
L	19.81	20.32	.780	.800
L1		4.50		.177
ÆP	3.55	3.65	.140	.144
Q	5.89	6.40	0.232	0.252
R	4.32	5.49	.170	.216
S	6.15	BSC	242	BSC

PRELIMINARY TECHNICAL INFORMATION

The product presented herein is under development. The Technical Specifications offered are derived from data gathered during objective characterizations of preliminary engineering lots; but also may yet contain some information supplied during a pre-production design evaluation. IXYS reserves the right to change limits, test conditions, and dimensions without notice.

IXYS reserves the right to change limits, test conditions, and dimensions.

IXYS MOSFETs and IGBTs are covered 4,835,592 4,931,844 5,049,961 5,237,481 6,162,665 6,404,065 B1 6,683,344 6,727,585 7,005,734 B2 7,157,338B2
by one or more of the following U.S. patents: 4,850,072 5,017,508 5,063,307 5,381,025 6,259,123 B1 6,534,343 6,710,405 B2 6,759,692 7,063,975 B2
4,881,106 5,034,796 5,187,117 5,486,715 6,306,728 B1 6,583,505 6,710,463 6,771,478 B2 7,071,537

**Fig. 1. Output Characteristics
@ 25°C**

**Fig. 2. Extended Output Characteristics
@ 25°C**

**Fig. 3. Output Characteristics
@ 150°C**

**Fig. 4. $R_{DS(on)}$ Normalized to $I_D = 80\text{A}$ Value
vs. Junction Temperature**

**Fig. 5. $R_{DS(on)}$ Normalized to $I_D = 80\text{A}$ Value
vs. Drain Current**

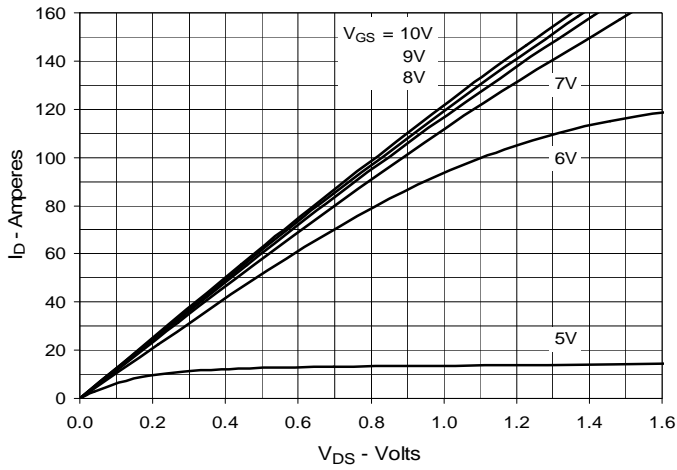
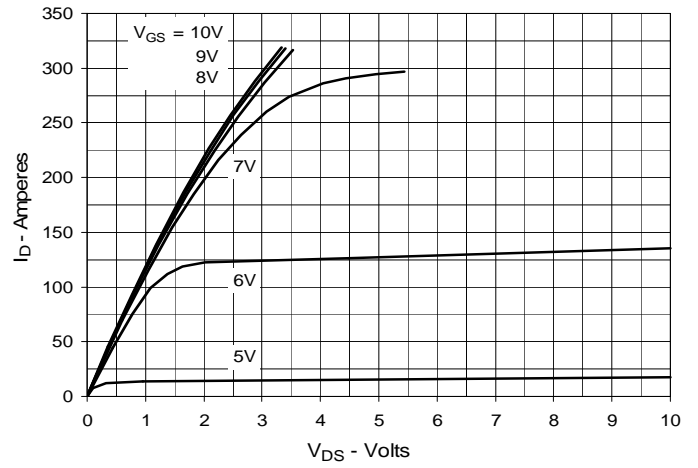
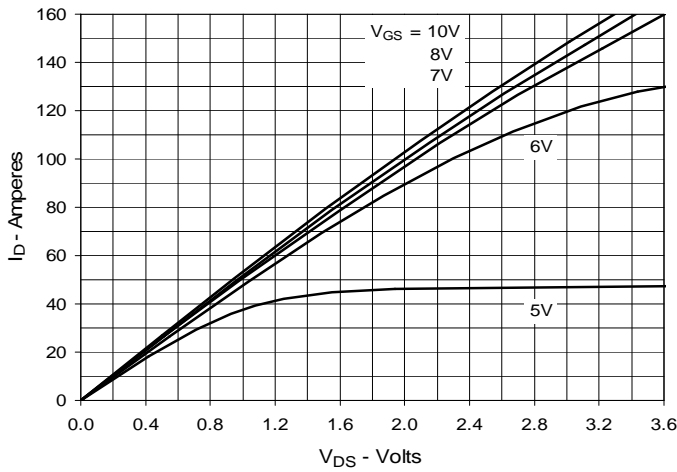
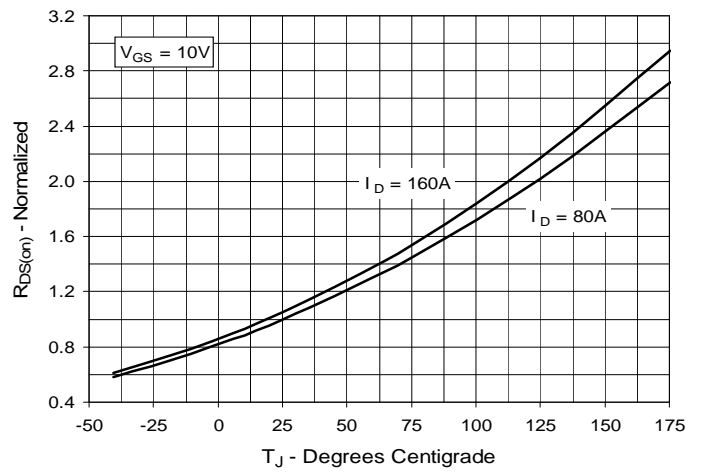
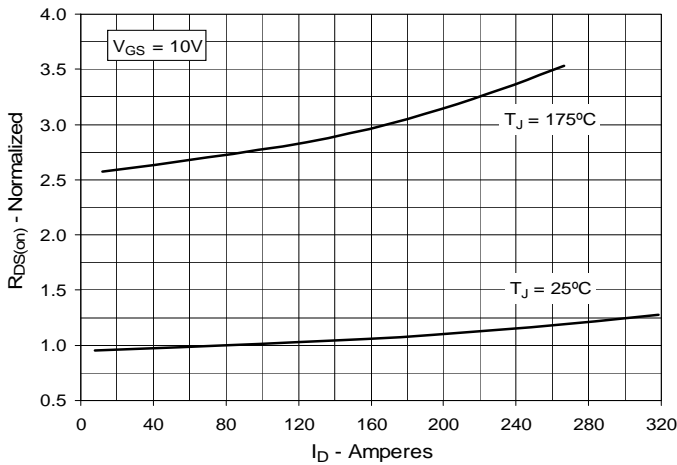
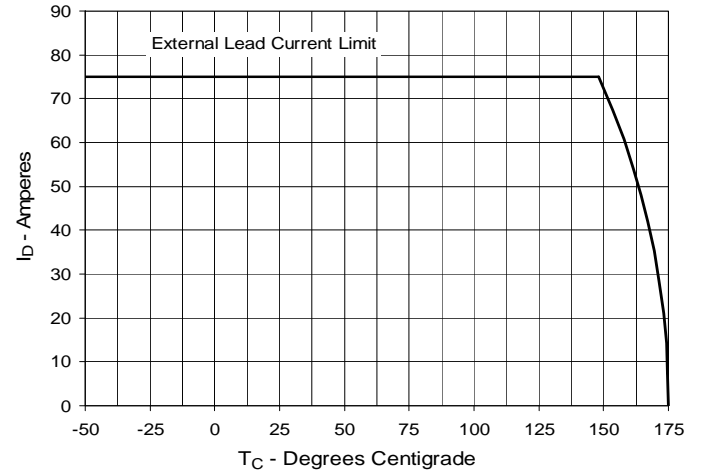
Fig. 6. Drain Current vs. Case Temperature

Fig. 7. Input Admittance

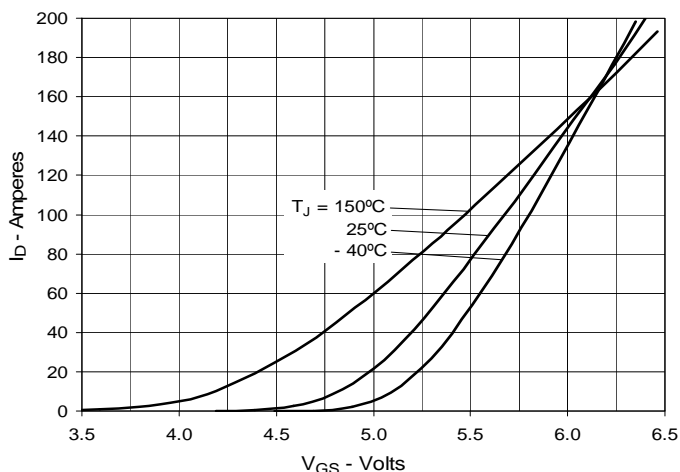

Fig. 8. Transconductance

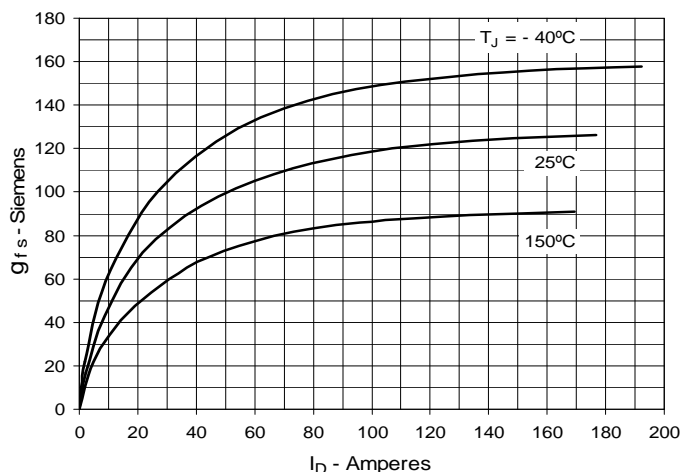

Fig. 9. Forward Voltage Drop of Intrinsic Diode

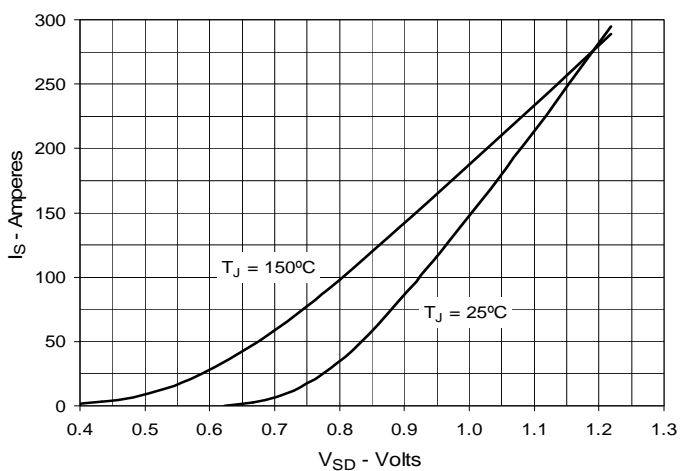

Fig. 10. Gate Charge

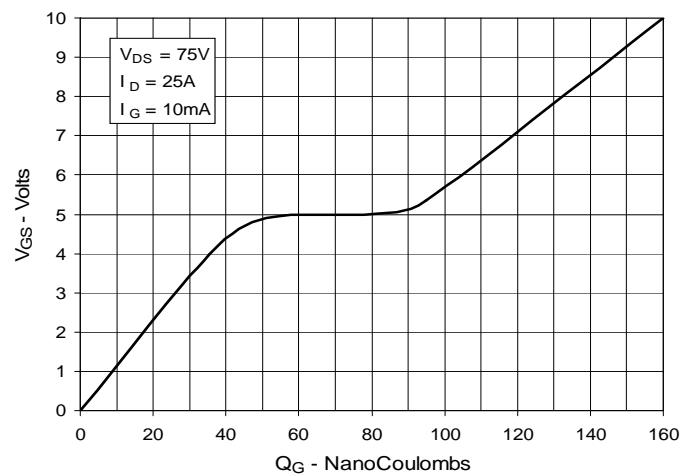

Fig. 11. Capacitance

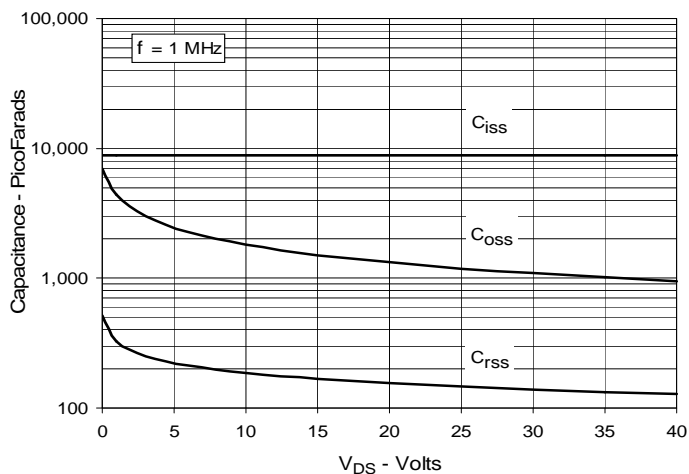

Fig. 12. Maximum Transient Thermal Impedance

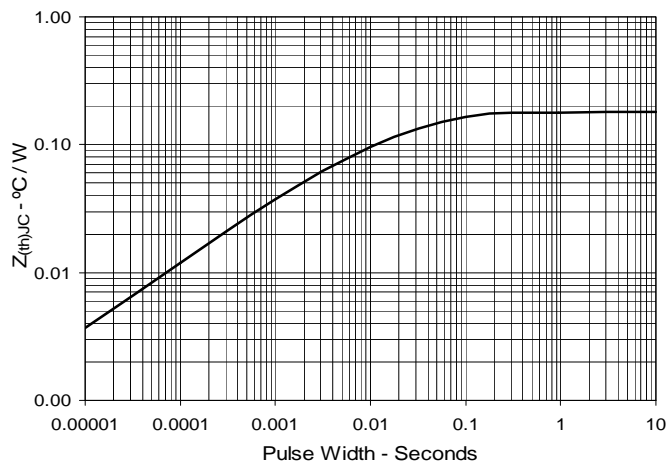

Fig. 13. Resistive Turn-on Rise Time vs. Junction Temperature

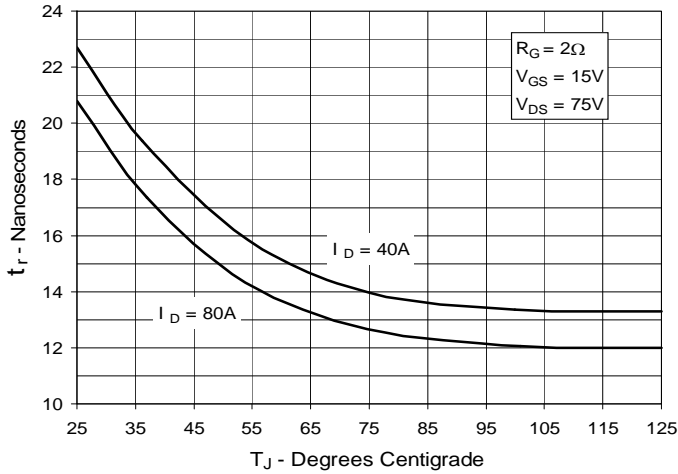

Fig. 14. Resistive Turn-on Rise Time vs. Drain Current

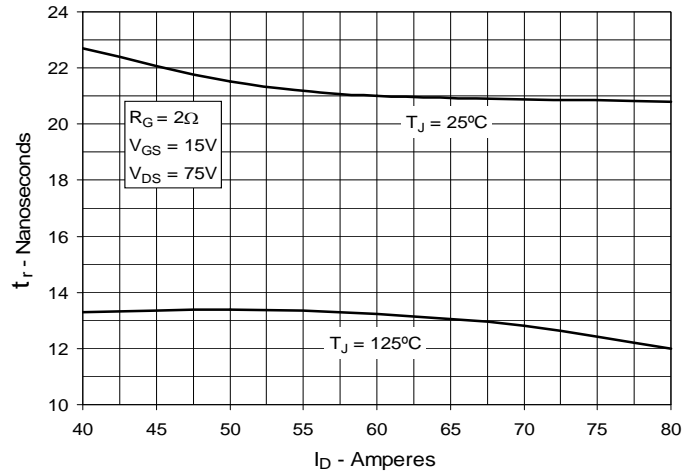

Fig. 15. Resistive Turn-on Switching Times vs. Gate Resistance

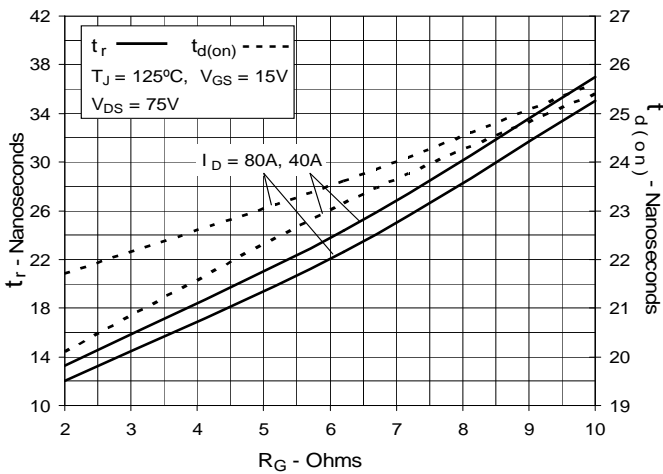

Fig. 16. Resistive Turn-off Switching Times vs. Junction Temperature

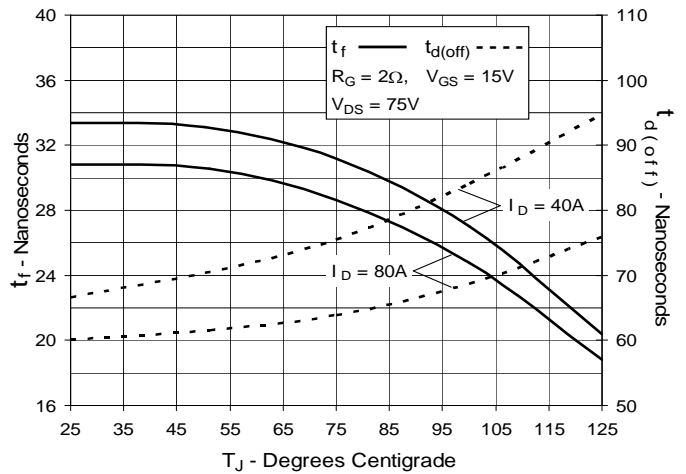

Fig. 17. Resistive Turn-off Switching Times vs. Drain Current

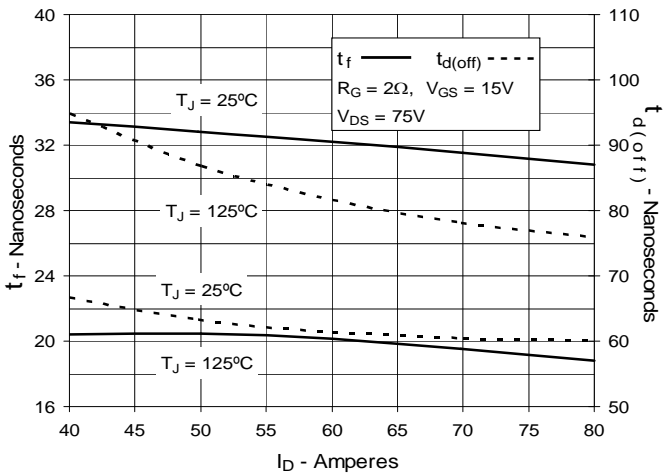
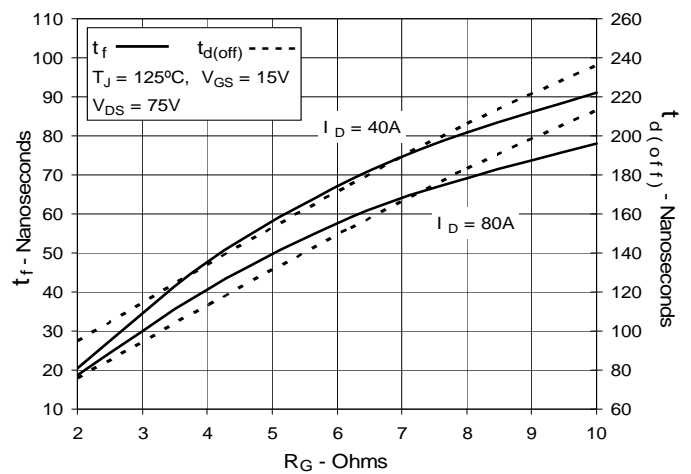

Fig. 18. Resistive Turn-off Switching Times vs. Gate Resistance





Disclaimer Notice - Information furnished is believed to be accurate and reliable. However, users should independently evaluate the suitability of and test each product selected for their own applications. Littelfuse products are not designed for, and may not be used in, all applications. Read complete Disclaimer Notice at www.littelfuse.com/disclaimer-electronics.