

**Trench HiperFET™  
Power MOSFET**
**IXFH230N10T**

$$V_{DSS} = 100V$$

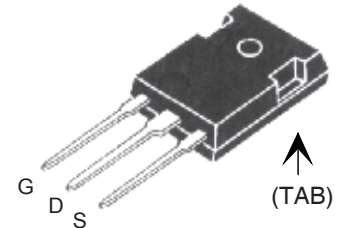
$$I_{D25} = 230A$$

$$R_{DS(on)} \leq 4.7m\Omega$$

N-Channel Enhancement Mode  
Avalanche Rated  
Fast Intrinsic Rectifier



TO-247



G = Gate      D = Drain  
S = Source    TAB = Drain

Symbol	Test Conditions	Maximum Ratings	
$V_{DSS}$	$T_J = 25^\circ\text{C}$ to $175^\circ\text{C}$	100	V
$V_{DGR}$	$T_J = 25^\circ\text{C}$ to $175^\circ\text{C}$ , $R_{GS} = 1M\Omega$	100	V
$V_{GSS}$	Continuous	$\pm 20$	V
$V_{GSM}$	Transient	$\pm 30$	V
$I_{D25}$	$T_C = 25^\circ\text{C}$	230	A
$I_{LRMS}$	Lead Current Limit, RMS	160	A
$I_{DM}$	$T_C = 25^\circ\text{C}$ , Pulse Width Limited by $T_{JM}$	500	A
$I_A$	$T_C = 25^\circ\text{C}$	115	A
$E_{AS}$	$T_C = 25^\circ\text{C}$	1.5	J
$P_D$	$T_C = 25^\circ\text{C}$	650	W
$T_J$		-55 ... +175	$^\circ\text{C}$
$T_{JM}$		175	$^\circ\text{C}$
$T_{stg}$		-55 ... +175	$^\circ\text{C}$
$T_L$	1.6mm (0.062in.) from Case for 10s	300	$^\circ\text{C}$
$T_{sold}$	Plastic Body for 10 Seconds	260	$^\circ\text{C}$
<b>Weight</b>		6	g

**Features**

- International Standard Package
- $175^\circ\text{C}$  Operating Temperature
- High Current Handling Capability
- Avalanche Rated
- Fast Intrinsic Rectifier
- Low  $R_{DS(on)}$

**Advantages**

- Easy to Mount
- Space Savings
- High Power Density

**Applications**

- DC-DC Converters
- Battery Chargers
- Switched-Mode and Resonant-Mode Power Supplies
- DC Choppers
- AC Motor Drives
- Uninterruptible Power Supplies
- High Speed Power Switching Applications

Symbol	Test Conditions ( $T_J = 25^\circ\text{C}$ Unless Otherwise Specified)	Characteristic Values		
		Min.	Typ.	Max.
$BV_{DSS}$	$V_{GS} = 0V$ , $I_D = 1mA$	100		V
$V_{GS(th)}$	$V_{DS} = V_{GS}$ , $I_D = 1mA$	2.5		V
$I_{GSS}$	$V_{GS} = \pm 20V$ , $V_{DS} = 0V$			$\pm 200$ nA
$I_{DSS}$	$V_{DS} = V_{DSS}$			50 $\mu\text{A}$
	$V_{GS} = 0V$ $T_J = 150^\circ\text{C}$			3 mA
$R_{DS(on)}$	$V_{GS} = 10V$ , $I_D = 0.5 \cdot I_{D25}$ Notes 1, 2			4.7 m $\Omega$

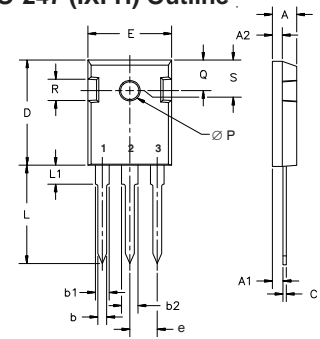
Symbol	Test Conditions ( $T_J = 25^\circ\text{C}$ , Unless Otherwise Specified)	Characteristic Values		
		Min.	Typ.	Max.
$g_{fs}$	$V_{DS} = 10\text{V}, I_D = 60\text{A}$ , Note 1	80	135	S
$C_{iss}$	$V_{GS} = 0\text{V}, V_{DS} = 25\text{V}, f = 1\text{MHz}$		15.3	nF
$C_{oss}$			1525	pF
$C_{rss}$			195	pF
$t_{d(on)}$	<b>Resistive Switching Times</b> $V_{GS} = 10\text{V}, V_{DS} = 0.5 \cdot V_{DSS}, I_D = 100\text{A}$ $R_G = 1\Omega$ (External)		29	ns
$t_r$			40	ns
$t_{d(off)}$			45	ns
$t_f$			15	ns
$Q_{g(on)}$	$V_{GS} = 10\text{V}, V_{DS} = 0.5 \cdot V_{DSS}, I_D = 0.5 \cdot I_{D25}$		250	nC
$Q_{gs}$			70	nC
$Q_{gd}$			65	nC
$R_{thJC}$			0.23	$^\circ\text{C/W}$
$R_{thCH}$		0.21		$^\circ\text{C/W}$

### Source-Drain Diode

Symbol	Test Conditions ( $T_J = 25^\circ\text{C}$ , Unless Otherwise Specified)	Characteristic Values		
		Min.	Typ.	Max.
$I_s$	$V_{GS} = 0\text{V}$			230 A
$I_{SM}$	Repetitive, Pulse Width Limited by $T_{JM}$			900 A
$V_{SD}$	$I_F = 100\text{A}, V_{GS} = 0\text{V}$ , Note 1			1.3 V
$t_{rr}$	$I_F = 100\text{A}, V_{GS} = 0\text{V}$ $-di/dt = 100\text{A}/\mu\text{s}$ $V_R = 50\text{V}$		82	ns
$I_{RM}$			4.8	A
$Q_{RM}$			196	nC

Note 1: Pulse Test,  $t \leq 300\mu\text{s}$ ; Duty Cycle,  $d \leq 2\%$ .

### TO-247 (IXFH) Outline



Terminals: 1 - Gate 2 - Drain

Dim.	Millimeter		Inches	
	Min.	Max.	Min.	Max.
A	4.7	5.3	.185	.209
A <sub>1</sub>	2.2	2.54	.087	.102
A <sub>2</sub>	2.2	2.6	.059	.098
b	1.0	1.4	.040	.055
b <sub>1</sub>	1.65	2.13	.065	.084
b <sub>2</sub>	2.87	3.12	.113	.123
C	.4	.8	.016	.031
D	20.80	21.46	.819	.845
E	15.75	16.26	.610	.640
e	5.20	5.72	0.205	0.225
L	19.81	20.32	.780	.800
L1		4.50		.177
ØP	3.55	3.65	.140	.144
Q	5.89	6.40	0.232	0.252
R	4.32	5.49	.170	.216

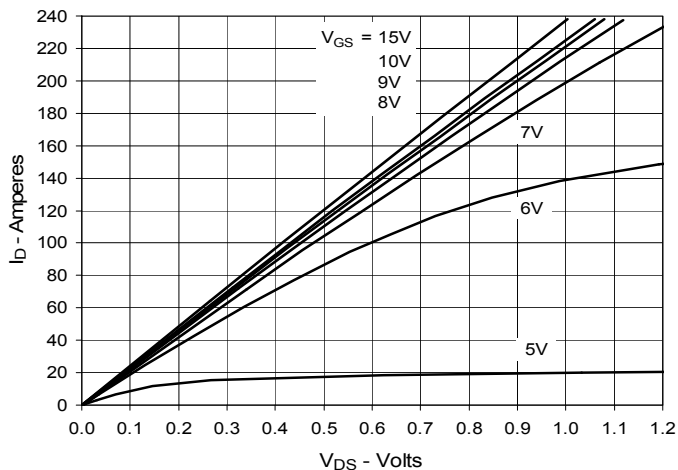
### PRELIMINARY TECHNICAL INFORMATION

The product presented herein is under development. The Technical Specifications offered are derived from data gathered during objective characterizations of preliminary engineering lots; but also may yet contain some information supplied during a pre-production design evaluation. IXYS reserves the right to change limits, test conditions, and dimensions without notice.

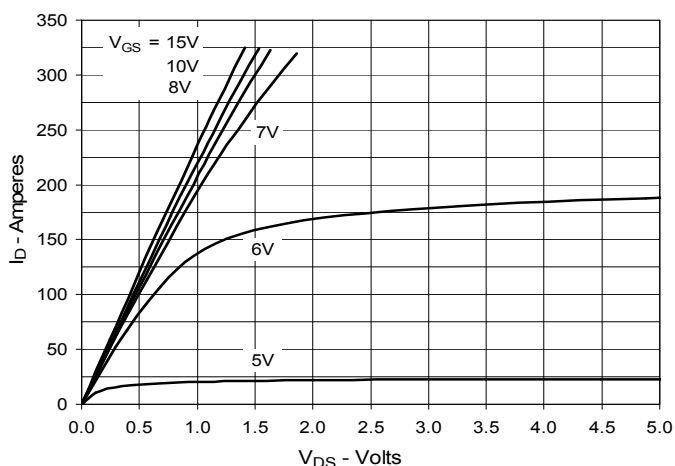
IXYS reserves the right to change limits, test conditions, and dimensions.

IXYS MOSFETs and IGBTs are covered by one or more of the following U.S. patents:	4,835,592	4,931,844	5,049,961	5,237,481	6,162,665	6,404,065 B1	6,683,344	6,727,585	7,005,734 B2	7,157,338B2
	4,850,072	5,017,508	5,063,307	5,381,025	6,259,123 B1	6,534,343	6,710,405 B2	6,759,692	7,063,975 B2	
	4,881,106	5,034,796	5,187,117	5,486,715	6,306,728 B1	6,583,505	6,710,463	6,771,478 B2	7,071,537	

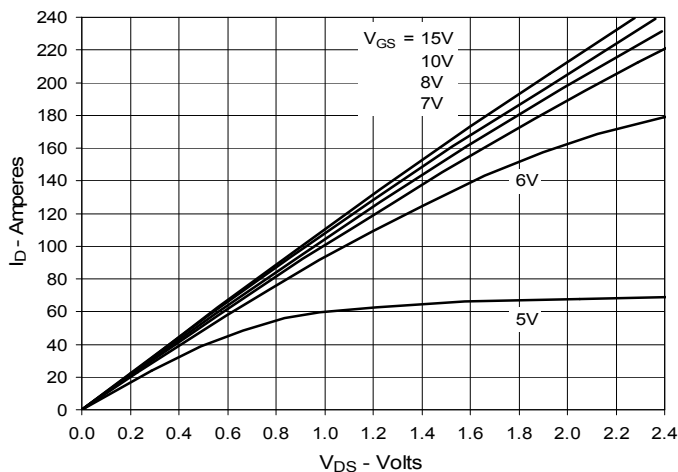
**Fig. 1. Output Characteristics @ 25°C**



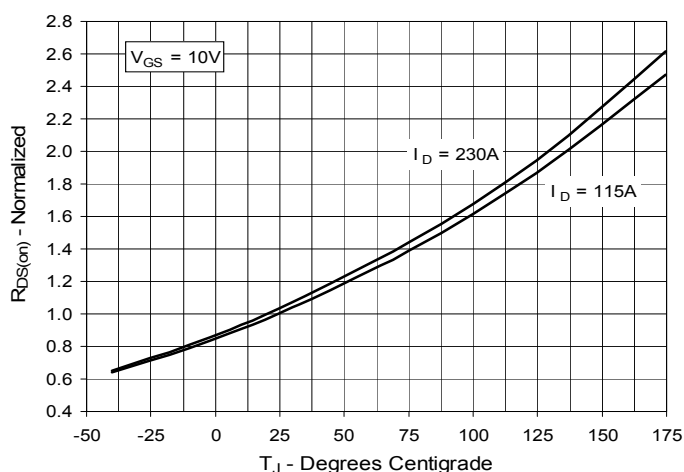
**Fig. 2. Extended Output Characteristics @ 25°C**



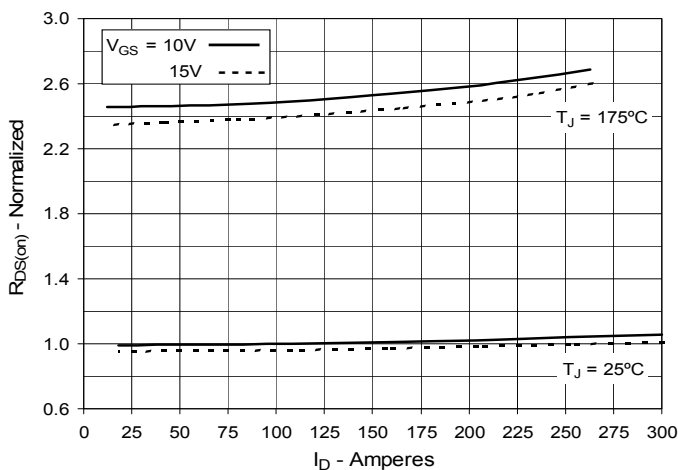
**Fig. 3. Output Characteristics @ 150°C**



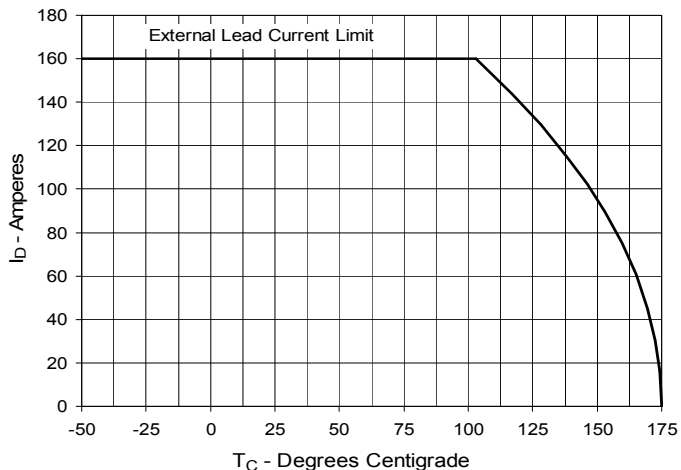
**Fig. 4.  $R_{DS(on)}$  Normalized to  $I_D = 115A$  Value vs. Junction Temperature**



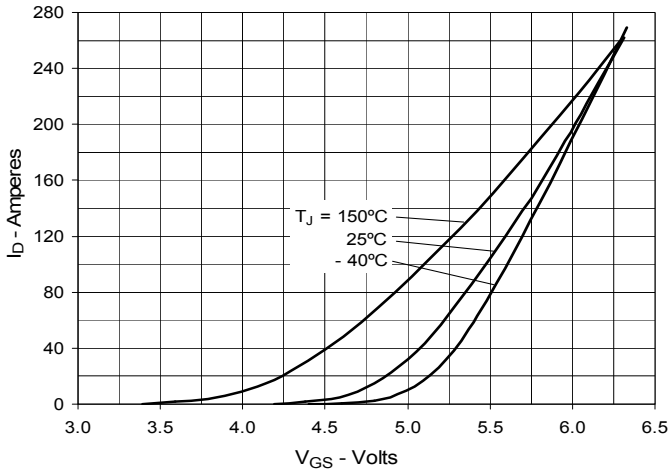
**Fig. 5.  $R_{DS(on)}$  Normalized to  $I_D = 115A$  Value vs. Drain Current**



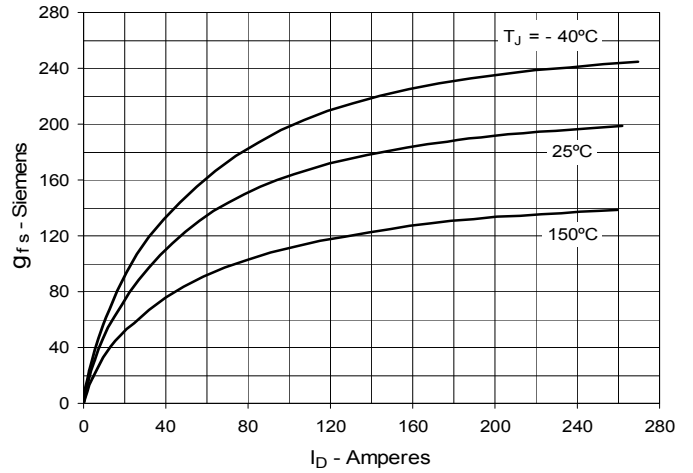
**Fig. 6. Drain Current vs. Case Temperature**



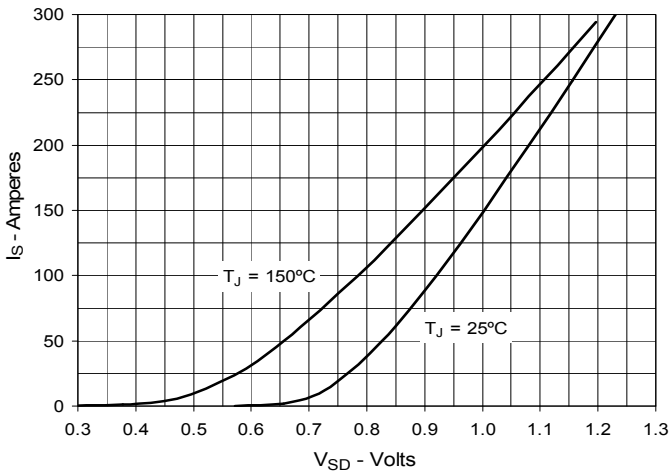
**Fig. 7. Input Admittance**



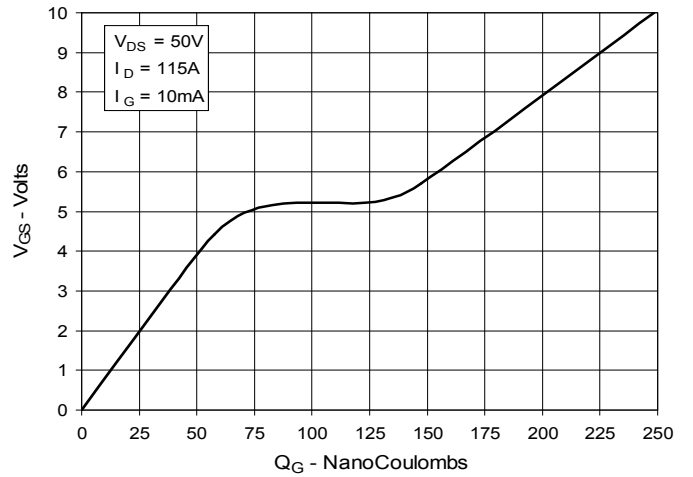
**Fig. 8. Transconductance**



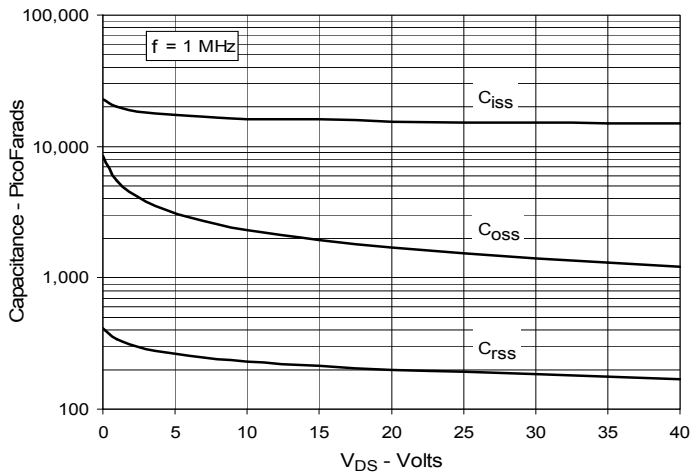
**Fig. 9. Forward Voltage Drop of Intrinsic Diode**



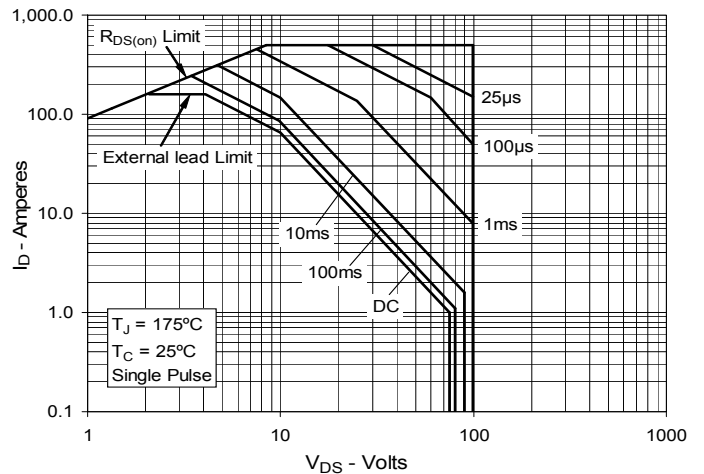
**Fig. 10. Gate Charge**



**Fig. 11. Capacitance**

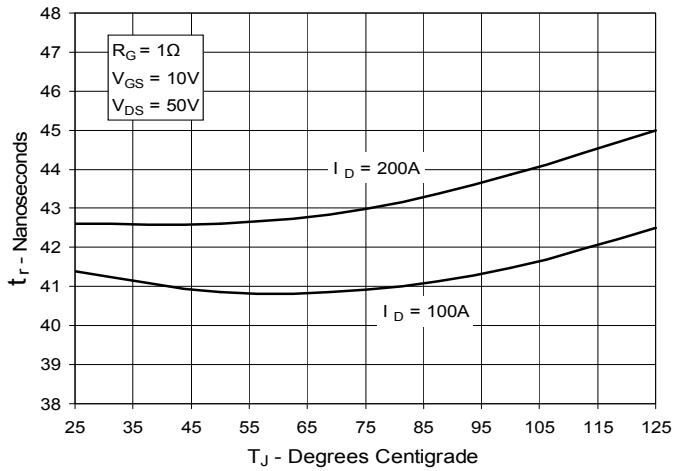


**Fig. 12. Forward-Bias Safe Operating Area**

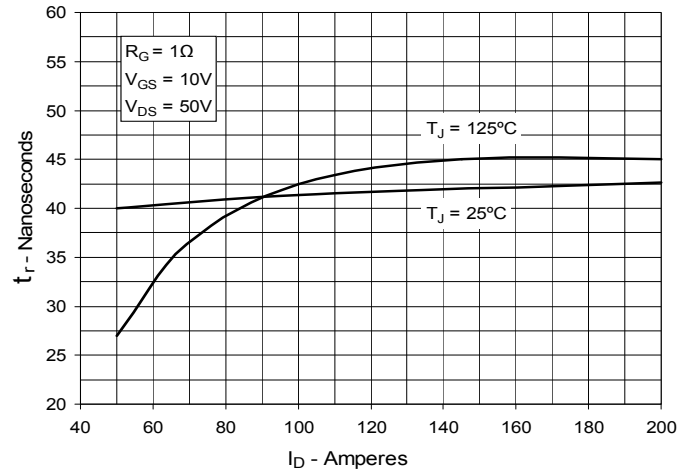


IXYS reserves the right to change limits, test conditions, and dimensions.

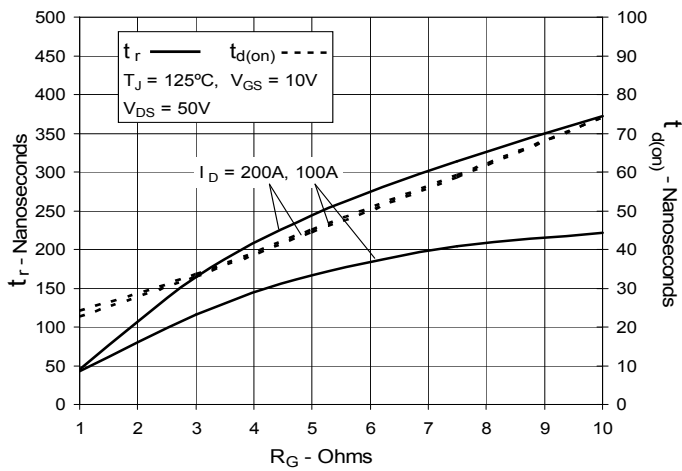
**Fig. 13. Resistive Turn-on Rise Time vs. Junction Temperature**



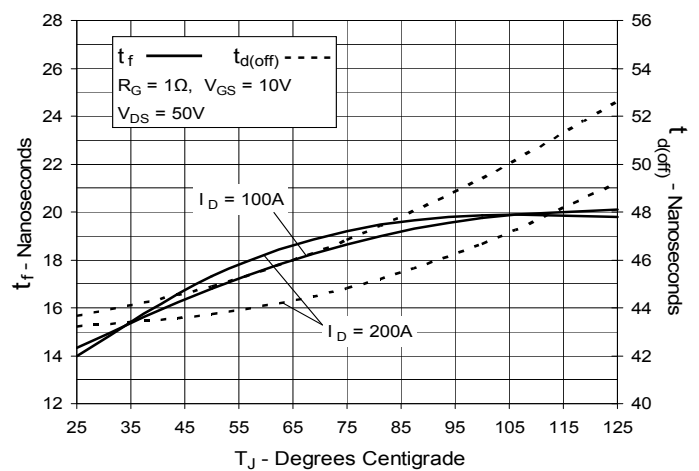
**Fig. 14. Resistive Turn-on Rise Time vs. Drain Current**



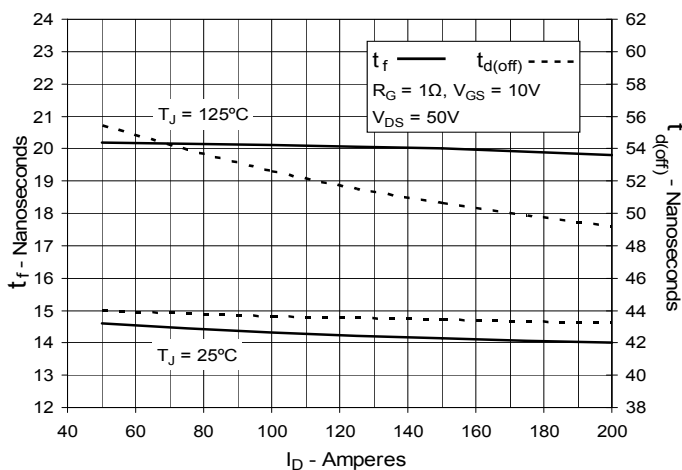
**Fig. 15. Resistive Turn-on Switching Times vs. Gate Resistance**



**Fig. 16. Resistive Turn-off Switching Times vs. Junction Temperature**



**Fig. 17. Resistive Turn-off Switching Times vs. Drain Current**



**Fig. 18. Resistive Turn-off Switching Times vs. Gate Resistance**

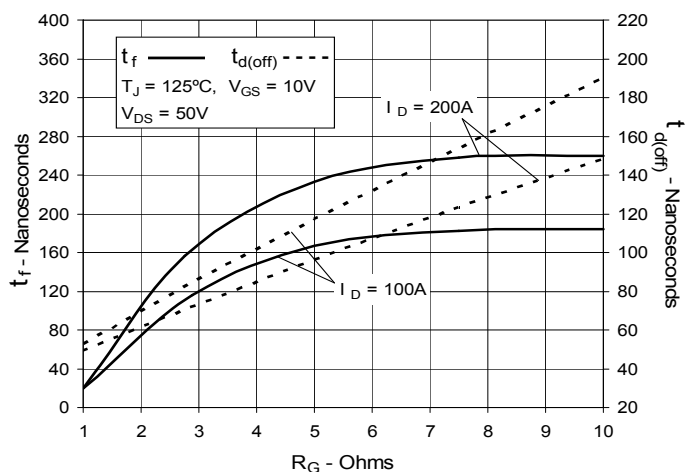
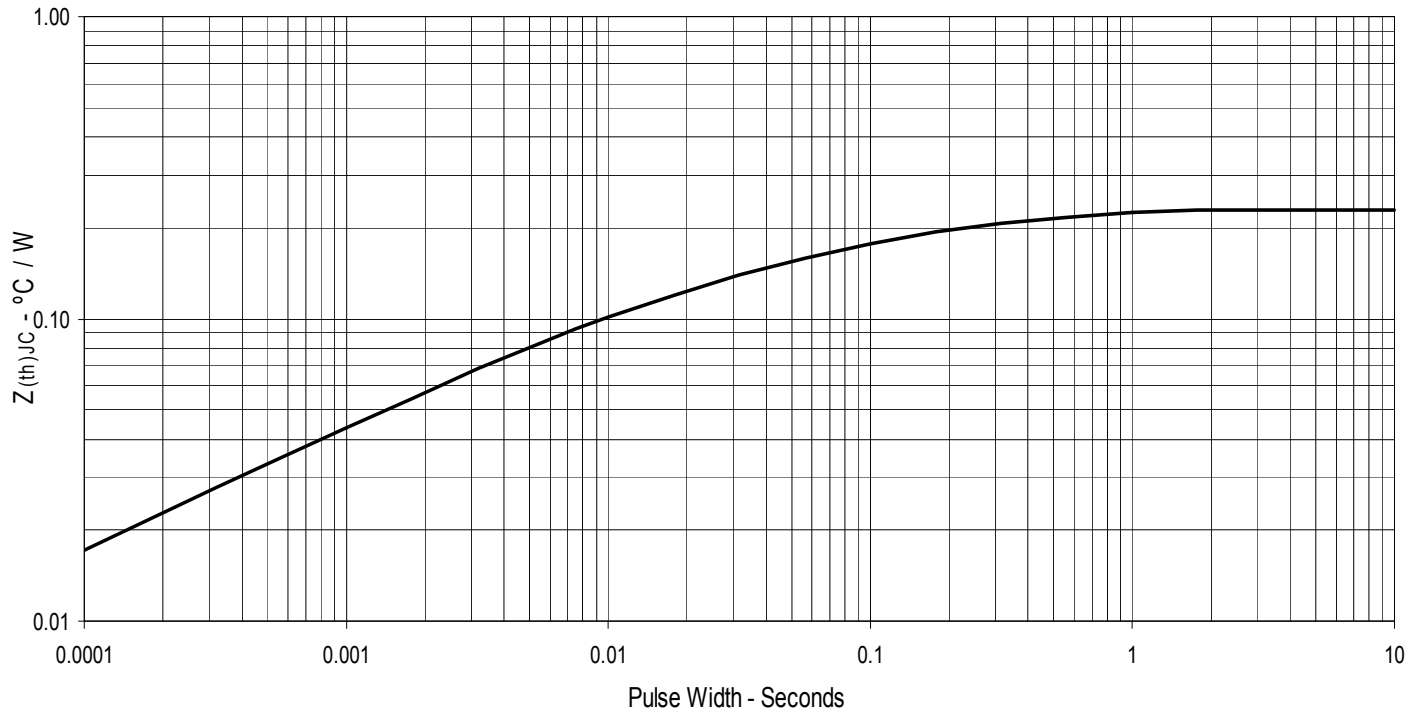


Fig. 19. Maximum Transient Thermal Impedance





---

Disclaimer Notice - Information furnished is believed to be accurate and reliable. However, users should independently evaluate the suitability of and test each product selected for their own applications. Littelfuse products are not designed for, and may not be used in, all applications. Read complete Disclaimer Notice at [www.littelfuse.com/disclaimer-electronics](http://www.littelfuse.com/disclaimer-electronics).