

TrenchMV™ Power MOSFET

IXTH130N10T IXTQ130N10T

$V_{DSS} = 100V$
 $I_{D25} = 130A$
 $R_{DS(on)} \leq 9.1m\Omega$

N-Channel Enhancement Mode
 Avalanche Rated



Symbol	Test Conditions	Maximum Ratings	
V_{DSS}	$T_J = 25^\circ C$ to $175^\circ C$	100	V
V_{DGR}	$T_J = 25^\circ C$ to $175^\circ C$, $R_{GS} = 1M\Omega$	100	V
V_{GSM}	Transient	± 20	V
I_{D25}	$T_C = 25^\circ C$	130	A
I_{LRMS}	Lead Current Limit, RMS	75	A
I_{DM}	$T_C = 25^\circ C$, pulse width limited by T_{JM}	300	A
I_A	$T_C = 25^\circ C$	65	A
E_{AS}	$T_C = 25^\circ C$	500	mJ
P_D	$T_C = 25^\circ C$	360	W
T_J		-55 ... +175	$^\circ C$
T_{JM}		175	$^\circ C$
T_{stg}		-55 ... +175	$^\circ C$
T_L	1.6mm (0.062in.) from case for 10s	300	$^\circ C$
	Plastic body for 10 seconds	260	$^\circ C$
M_d	Mounting torque (TO-247)(TO-3P)	1.13 / 10	Nm/lb.in.
Weight	TO-247	6.0	g
	TO-3P	5.5	g

TO-247 (IXTH)

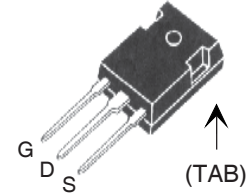

TO-3P (IXTQ)

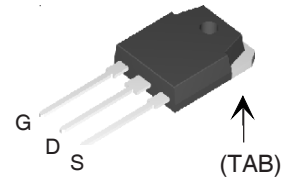

G = Gate D = Drain
 S = Source TAB = Drain

Features

- Ultra-low On Resistance
- Unclamped Inductive Switching (UIS) rated
- Low package inductance
 - easy to drive and to protect
- 175 °C Operating Temperature

Advantages

- Easy to mount
- Space savings
- High power density

Applications

- Automotive
 - Motor Drives
 - High Side Switch
 - 12V Battery
 - ABS Systems
- DC/DC Converters and Off-line UPS
- Primary- Side Switch
- High Current Switching Applications

Symbol	Test Conditions ($T_J = 25^\circ C$ unless otherwise specified)	Characteristic Values		
		Min.	Typ.	Max.
BV_{DSS}	$V_{GS} = 0V$, $I_D = 250\mu A$	100		V
$V_{GS(th)}$	$V_{DS} = V_{GS}$, $I_D = 250\mu A$	2.5		4.5 V
I_{GSS}	$V_{GS} = \pm 20V$, $V_{DS} = 0V$			± 200 nA
I_{DSS}	$V_{DS} = V_{DSS}$			5 μA
	$V_{GS} = 0V$ $T_J = 150^\circ C$			250 μA
$R_{DS(on)}$	$V_{GS} = 10V$, $I_D = 25A$, Notes 1, 2			9.1 m Ω

Symbol	Test Conditions	Characteristic Values		
		Min.	Typ.	Max.
$(T_J = 25^\circ\text{C unless otherwise specified})$				
g_{fs}	$V_{DS} = 10\text{V}, I_D = 60\text{A}, \text{Note 1}$	55	93	S
C_{iss}	$V_{GS} = 0\text{V}, V_{DS} = 25\text{V}, f = 1\text{MHz}$		5080	pF
C_{oss}			635	pF
C_{rss}			95	pF
$t_{d(on)}$	Resistive Switching Times $V_{GS} = 10\text{V}, V_{DS} = 0.5 \cdot V_{DSS}, I_D = 25\text{A}$ $R_G = 5\Omega \text{ (External)}$		30	ns
t_r			47	ns
$t_{d(off)}$			44	ns
t_f			28	ns
$Q_{g(on)}$	$V_{GS} = 10\text{V}, V_{DS} = 0.5 \cdot V_{DSS}, I_D = 25\text{A}$		104	nC
Q_{gs}			30	nC
Q_{gd}			29	nC
R_{thJC}			0.42	$^\circ\text{C/W}$
R_{thCH}		0.25		$^\circ\text{C/W}$

Source-Drain Diode

Symbol	Test Conditions	Characteristic Values		
		Min.	Typ.	Max.
$T_J = 25^\circ\text{C unless otherwise specified}$				
I_S	$V_{GS} = 0\text{V}$			130 A
I_{SM}	Repetitive, pulse width limited by T_{JM}			350 A
V_{SD}	$I_F = 25\text{A}, V_{GS} = 0\text{V}, \text{Note 1}$			1.0 V
t_{rr}	$I_F = 25\text{A}, V_{GS} = 0\text{V}$ $-di/dt = 100\text{A}/\mu\text{s}$ $V_R = 50\text{V}$		67	ns
I_{RM}			4.7	A
Q_{rr}			160	nC

- Notes: 1. Pulse test, $t \leq 300\mu\text{s}$; duty cycle, $d \leq 2\%$.
2. On through-hole packages, $R_{DS(on)}$ Kelvin test contact location must be 5mm or less from the package body.

TO-247 (IXTH) Outline

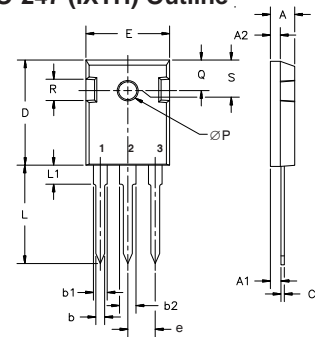

Terminals: 1 - Gate 2 - Drain

Dim.	Millimeter		Inches	
	Min.	Max.	Min.	Max.
A	4.7	5.3	.185	.209
A ₁	2.2	2.54	.087	.102
A ₂	2.2	2.6	.059	.098
b	1.0	1.4	.040	.055
b ₁	1.65	2.13	.065	.084
b ₂	2.87	3.12	.113	.123
C	.4	.8	.016	.031
D	20.80	21.46	.819	.845
E	15.75	16.26	.610	.640
e	5.20	5.72	0.205	0.225
L	19.81	20.32	.780	.800
L1		4.50		.177
ØP	3.55	3.65	.140	.144
Q	5.89	6.40	0.232	0.252
R	4.32	5.49	.170	.216

TO-3P (IXTQ) Outline

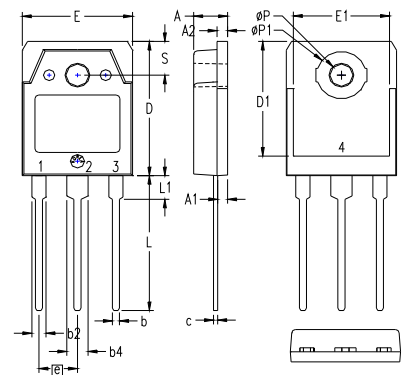

Pins: 1 - Gate 2 - Drain
3 - Source 4, TAB - Drain

SYM	INCHES		MILLIMETERS	
	MIN	MAX	MIN	MAX
A	.185	.193	4.70	4.90
A1	.051	.059	1.30	1.50
A2	.057	.065	1.45	1.65
b	.035	.045	0.90	1.15
b2	.075	.087	1.90	2.20
b4	.114	.126	2.90	3.20
c	.022	.031	0.55	0.80
D	.780	.791	19.80	20.10
D1	.665	.677	16.90	17.20
E	.610	.622	15.50	15.80
E1	.531	.539	13.50	13.70
e	.215 BSC		5.45 BSC	
L	.779	.795	19.80	20.20
L1	.134	.142	3.40	3.60
ØP	.126	.134	3.20	3.40
ØP1	.272	.280	6.90	7.10
S	.193	.201	4.90	5.10

All metal area are tin plated.

IXYS reserves the right to change limits, test conditions, and dimensions.

IXYS MOSFETs and IGBTs are covered by one or more of the following U.S. patents:	4,835,592	4,931,844	5,049,961	5,237,481	6,162,665	6,404,065 B1	6,683,344	6,727,585	7,005,734 B2	7,157,338B2
	4,850,072	5,017,508	5,063,307	5,381,025	6,259,123 B1	6,534,343	6,710,405 B2	6,759,692	7,063,975 B2	
	4,881,106	5,034,796	5,187,117	5,486,715	6,306,728 B1	6,583,505	6,710,463	6,771,478 B2	7,071,537	

Fig. 1. Output Characteristics @ 25°C

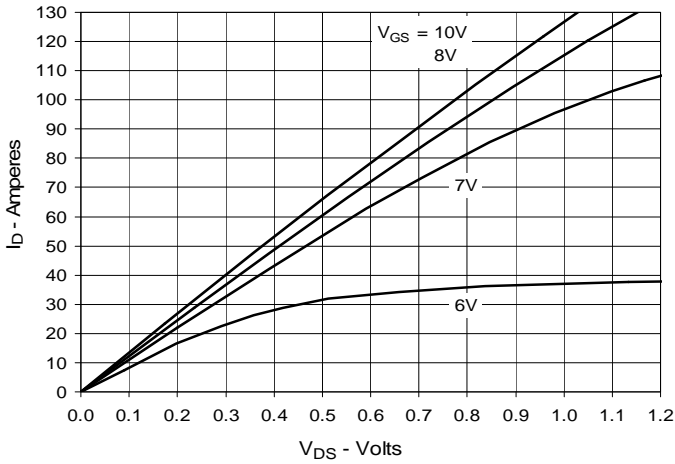

Fig. 2. Extended Output Characteristics @ 25°C

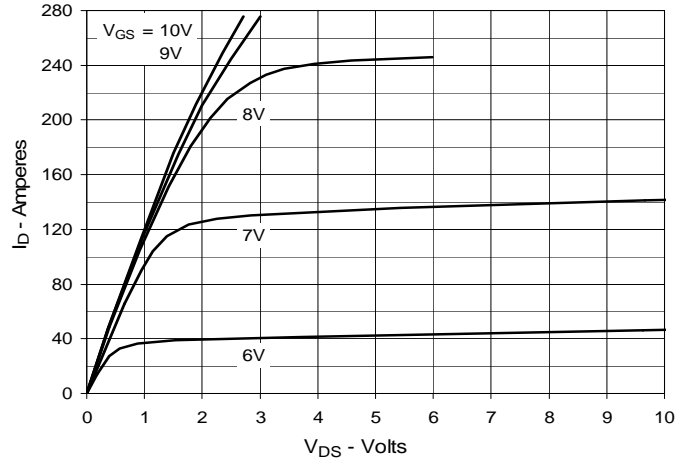

Fig. 3. Output Characteristics @ 150°C

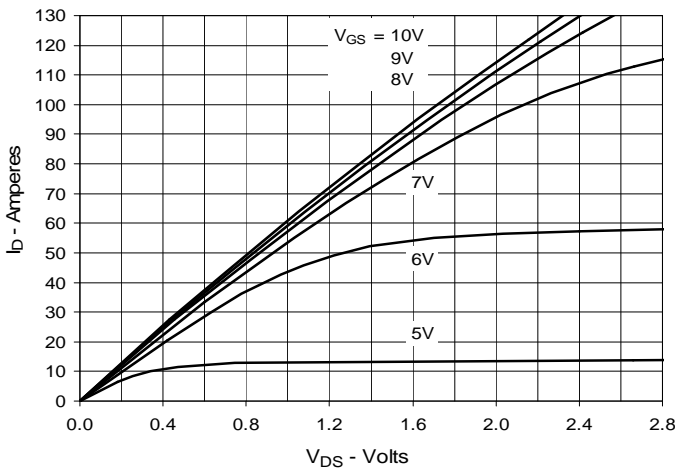

Fig. 4. $R_{DS(on)}$ Normalized to $I_D = 65A$ Value vs. Junction Temperature

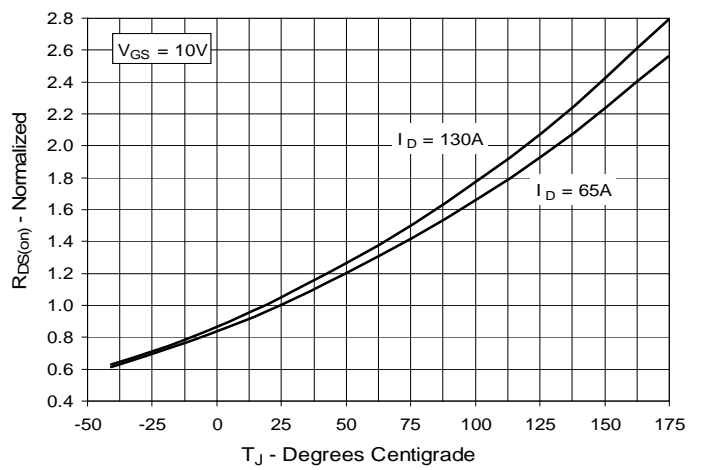

Fig. 5. $R_{DS(on)}$ Normalized to $I_D = 65A$ Value vs. Drain Current

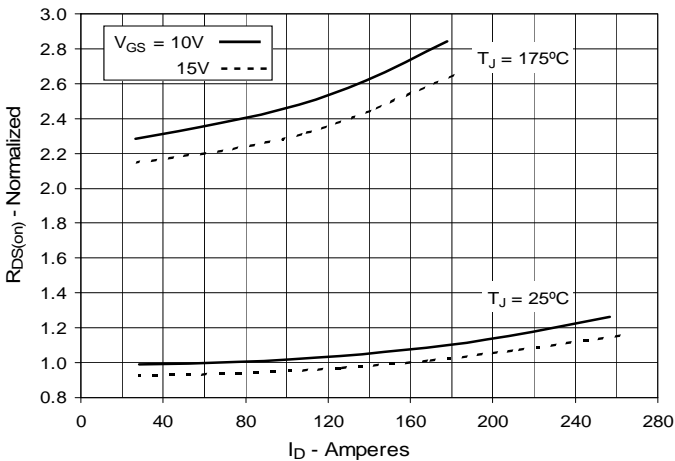

Fig. 6. Drain Current vs. Case Temperature

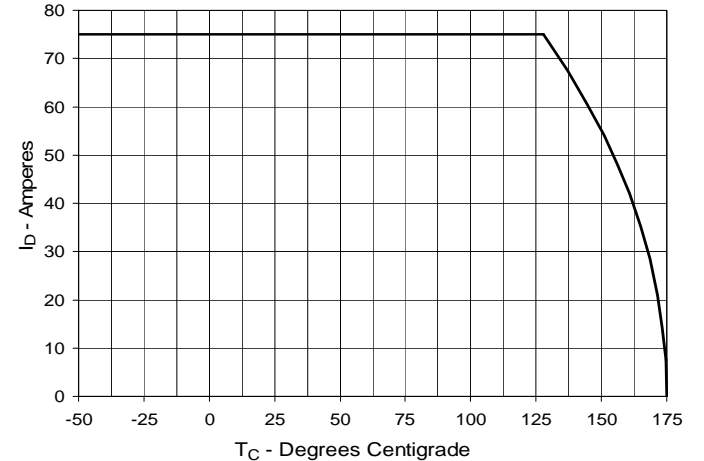

Fig. 7. Input Admittance

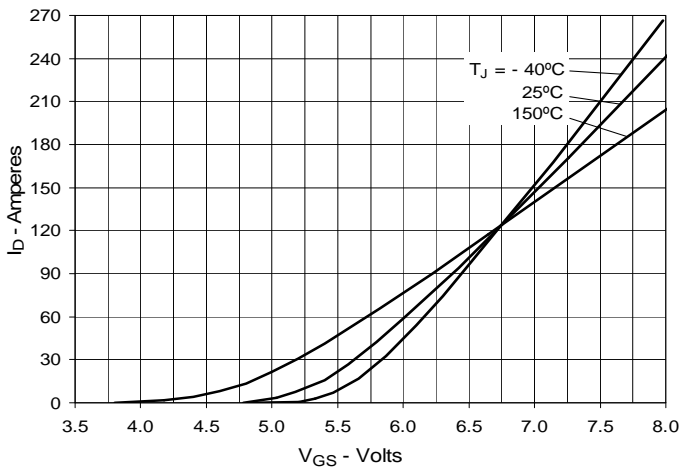

Fig. 8. Transconductance

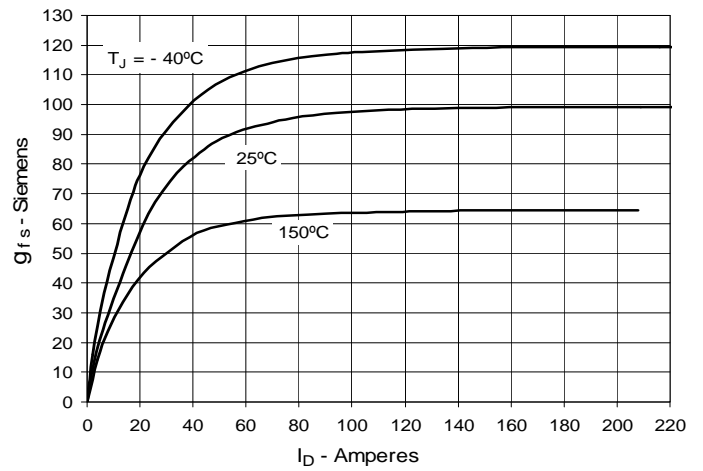

Fig. 9. Forward Voltage Drop of Intrinsic Diode

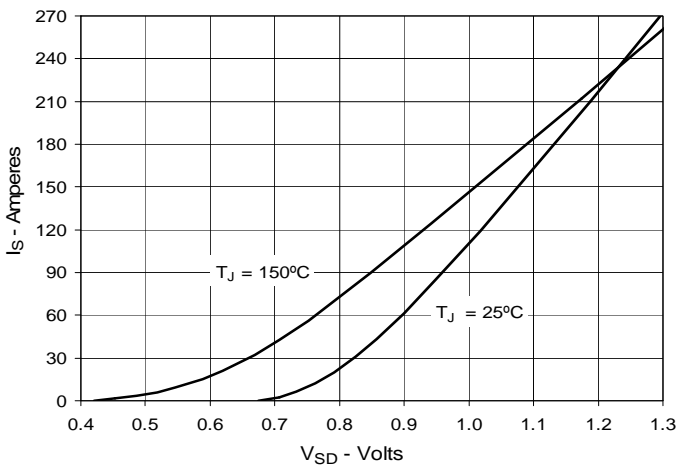

Fig. 10. Gate Charge

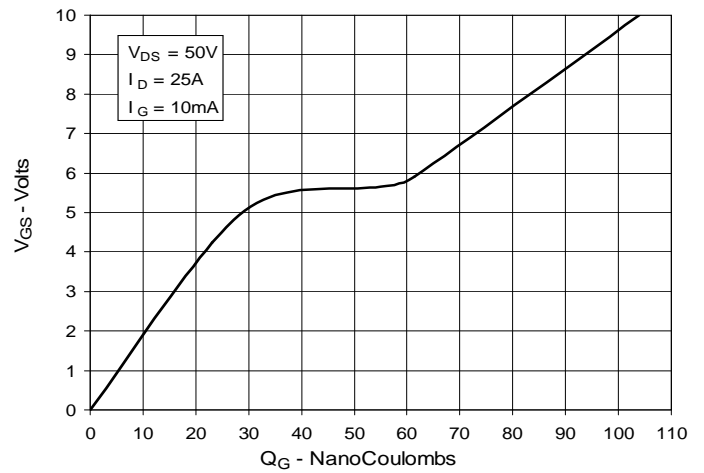

Fig. 11. Capacitance

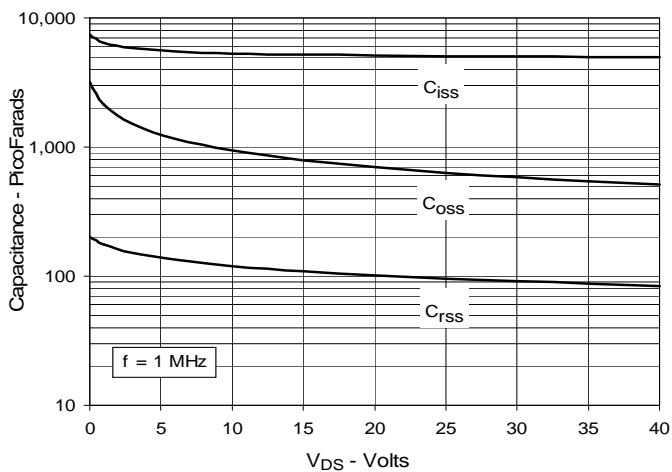

Fig. 12. Maximum Transient Thermal Impedance

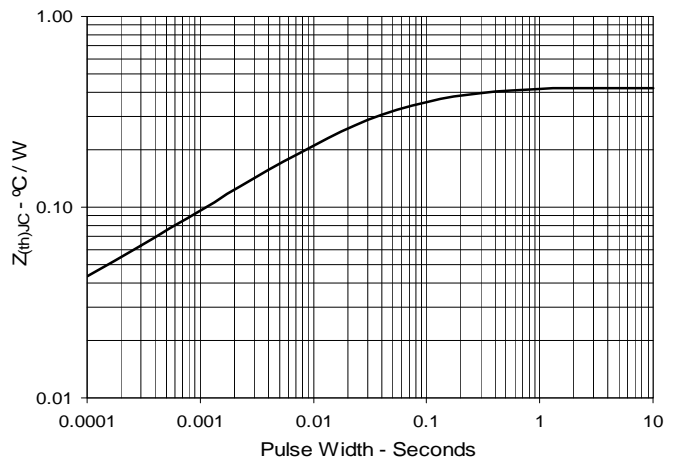

Fig. 13. Resistive Turn-on Rise Time vs. Junction Temperature

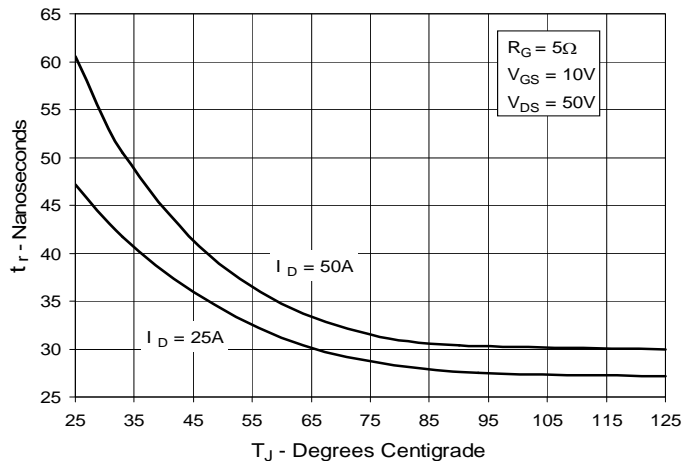

Fig. 14. Resistive Turn-on Rise Time vs. Drain Current

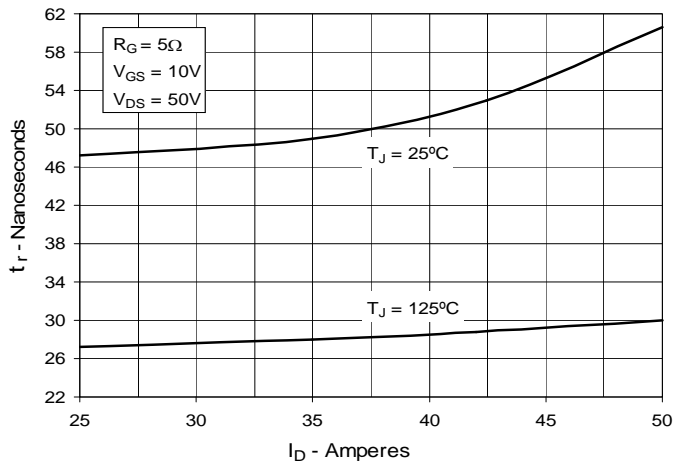

Fig. 15. Resistive Turn-on Switching Times vs. Gate Resistance

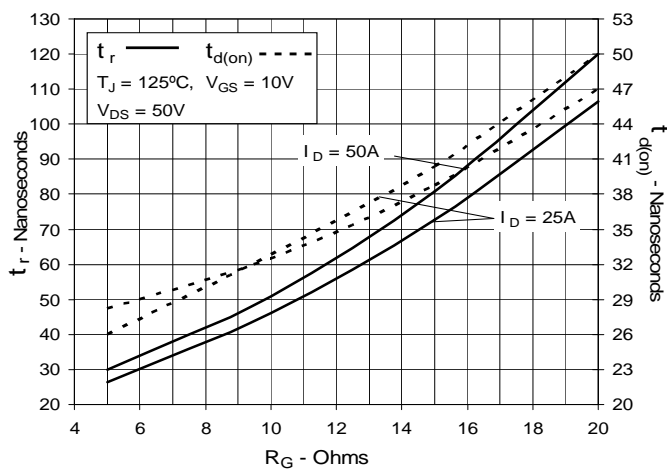

Fig. 16. Resistive Turn-off Switching Times vs. Junction Temperature

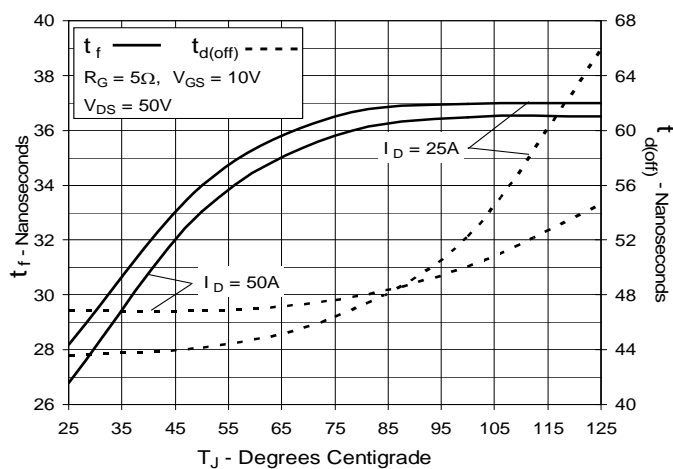

Fig. 17. Resistive Turn-off Switching Times vs. Drain Current

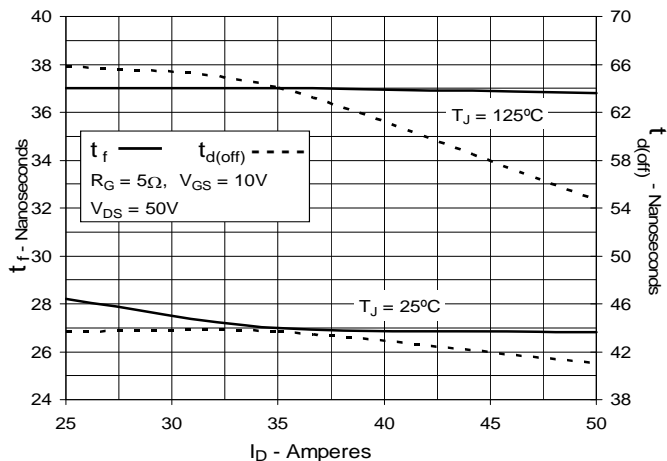
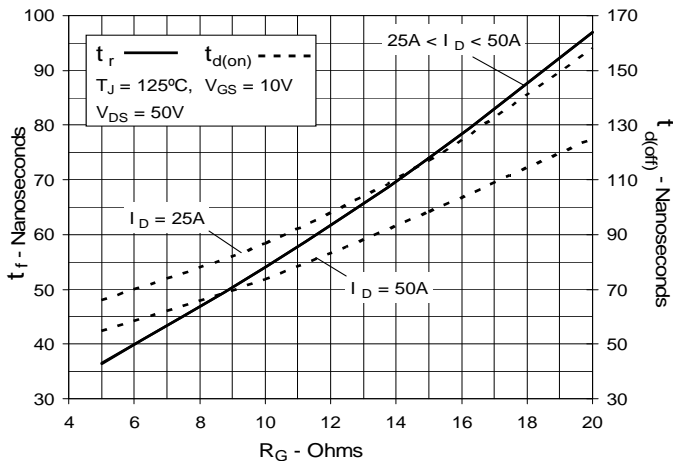

Fig. 18. Resistive Turn-off Switching Times vs. Gate Resistance





Disclaimer Notice - Information furnished is believed to be accurate and reliable. However, users should independently evaluate the suitability of and test each product selected for their own applications. Littelfuse products are not designed for, and may not be used in, all applications. Read complete Disclaimer Notice at www.littelfuse.com/disclaimer-electronics.