

# TrenchMV™ Power MOSFET

## IXTH200N10T IXTQ200N10T

$V_{DSS} = 100V$   
 $I_{D25} = 200A$   
 $R_{DS(on)} \leq 5.5m\Omega$

N-Channel Enhancement Mode  
 Avalanche Rated



Symbol	Test Conditions	Maximum Ratings	
$V_{DSS}$	$T_J = 25^\circ C$ to $175^\circ C$	100	V
$V_{DGR}$	$T_J = 25^\circ C$ to $175^\circ C$ , $R_{GS} = 1M\Omega$	100	V
$V_{GSM}$	Transient	$\pm 30$	V
$I_{D25}$	$T_C = 25^\circ C$	200	A
$I_{LRMS}$	Lead Current Limit, RMS	75	A
$I_{DM}$	$T_C = 25^\circ C$ , pulse width limited by $T_{JM}$	500	A
$I_A$	$T_C = 25^\circ C$	40	A
$E_{AS}$	$T_C = 25^\circ C$	1.5	J
$P_D$	$T_C = 25^\circ C$	550	W
$T_J$		-55 ... +175	$^\circ C$
$T_{JM}$		175	$^\circ C$
$T_{stg}$		-55 ... +175	$^\circ C$
$T_L$	1.6mm (0.062in.) from case for 10s Plastic body for 10 seconds	300 260	$^\circ C$ $^\circ C$
$M_d$	Mounting torque	1.13 / 10	Nm/lb.in.
Weight	TO-247	6.0	g
	TO-3P	5.5	g

TO-247 (IXTH)

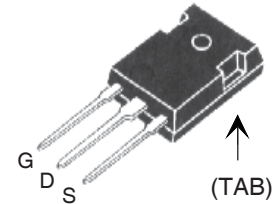

TO-3P (IXTQ)

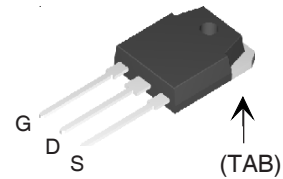

G = Gate      D = Drain  
 S = Source    TAB = Drain

### Features

- International standard packages
- 175°C Operating Temperature
- Avalanche Rated
- Low  $R_{DS(on)}$

### Advantages

- Easy to mount
- Space savings
- High power density

### Applications

- Automotive
  - Motor Drives
  - High Side Switch
  - 12V Battery
  - ABS Systems
- DC/DC Converters and Off-line UPS
- Primary - Side Switch
- High Current Switching Applications

Symbol	Test Conditions	Characteristic Values		
		Min.	Typ.	Max.
$BV_{DSS}$	$V_{GS} = 0V$ , $I_D = 250\mu A$	100		V
$V_{GS(th)}$	$V_{DS} = V_{GS}$ , $I_D = 250\mu A$	2.5		4.5 V
$I_{GSS}$	$V_{GS} = \pm 20V$ , $V_{DS} = 0V$			$\pm 200$ nA
$I_{DSS}$	$V_{DS} = V_{DSS}$			5 $\mu A$
	$V_{GS} = 0V$ $T_J = 150^\circ C$			250 $\mu A$
$R_{DS(on)}$	$V_{GS} = 10V$ , $I_D = 50A$ , Notes 1, 2	4.5		5.5 m $\Omega$

Symbol	Test Conditions ( $T_J = 25^\circ\text{C}$ , unless otherwise specified)	Characteristic Values		
		Min.	Typ.	Max.
$g_{fs}$	$V_{DS} = 10\text{V}$ , $I_D = 60\text{A}$ , Note 1	60	96	S
$C_{iss}$	$V_{GS} = 0\text{V}$ , $V_{DS} = 25\text{V}$ , $f = 1\text{MHz}$		9400	pF
$C_{oss}$			1087	pF
$C_{rss}$			140	pF
$t_{d(on)}$	<b>Resistive Switching Times</b> $V_{GS} = 10\text{V}$ , $V_{DS} = 0.5 \cdot V_{DSS}$ , $I_D = 50\text{A}$ $R_G = 3.3\Omega$ (External)		35	ns
$t_r$			31	ns
$t_{d(off)}$			45	ns
$t_f$			34	ns
$Q_{g(on)}$	$V_{GS} = 10\text{V}$ , $V_{DS} = 0.5 \cdot V_{DSS}$ , $I_D = 50\text{A}$		152	nC
$Q_{gs}$			47	nC
$Q_{gd}$			47	nC
$R_{thJC}$			0.27	$^\circ\text{C/W}$
$R_{thCH}$		0.25		$^\circ\text{C/W}$

### Source-Drain Diode

Symbol	Test Conditions ( $T_J = 25^\circ\text{C}$ , unless otherwise specified)	Characteristic Values		
		Min.	Typ.	Max.
$I_S$	$V_{GS} = 0\text{V}$			200 A
$I_{SM}$	Repetitive, Pulse width limited by $T_{JM}$			500 A
$V_{SD}$	$I_F = 50\text{A}$ , $V_{GS} = 0\text{V}$ , Note 1			1.0 V
$t_{rr}$	$I_F = 100\text{A}$ , $V_{GS} = 0\text{V}$ , $-di/dt = 100\text{A}/\mu\text{s}$ $V_R = 50\text{V}$		76	ns
$Q_{RM}$			205	nC
$I_{RM}$			5.4	A

- Notes: 1. Pulse test,  $t \leq 300\mu\text{s}$ ; duty cycle,  $d \leq 2\%$ .  
2. On through-hole packages,  $R_{DS(on)}$  Kelvin test contact location must be 5mm or less from the package body.

### TO-247 (IXTH) Outline

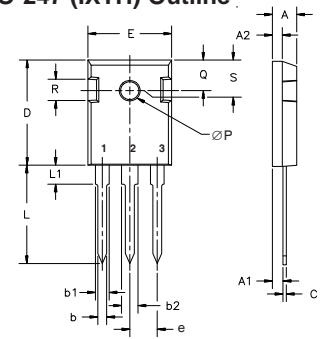

Terminals: 1 - Gate 2 - Drain

Dim.	Millimeter		Inches	
	Min.	Max.	Min.	Max.
A	4.7	5.3	.185	.209
A <sub>1</sub>	2.2	2.54	.087	.102
A <sub>2</sub>	2.2	2.6	.059	.098
b	1.0	1.4	.040	.055
b <sub>1</sub>	1.65	2.13	.065	.084
b <sub>2</sub>	2.87	3.12	.113	.123
C	.4	.8	.016	.031
D	20.80	21.46	.819	.845
E	15.75	16.26	.610	.640
e	5.20	5.72	0.205	0.225
L	19.81	20.32	.780	.800
L1		4.50		.177
ØP	3.55	3.65	.140	.144
Q	5.89	6.40	0.232	0.252
R	4.32	5.49	.170	.216

### TO-3P (IXTQ) Outline

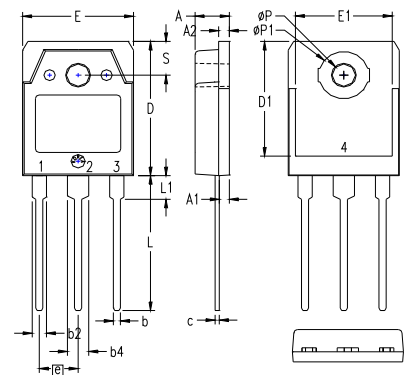

Pins: 1 - Gate 2 - Drain  
3 - Source 4, TAB - Drain

SYM	INCHES		MILLIMETERS	
	MIN	MAX	MIN	MAX
A	.185	.193	4.70	4.90
A1	.051	.059	1.30	1.50
A2	.057	.065	1.45	1.65
b	.035	.045	0.90	1.15
b2	.075	.087	1.90	2.20
b4	.114	.126	2.90	3.20
c	.022	.031	0.55	0.80
D	.780	.791	19.80	20.10
D1	.665	.677	16.90	17.20
E	.610	.622	15.50	15.80
E1	.531	.539	13.50	13.70
e	.215 BSC		5.45 BSC	
L	.779	.795	19.80	20.20
L1	.134	.142	3.40	3.60
ØP	.126	.134	3.20	3.40
ØP1	.272	.280	6.90	7.10
S	.193	.201	4.90	5.10

All metal area are tin plated.

IXYS reserves the right to change limits, test conditions, and dimensions.

IXYS MOSFETs and IGBTs are covered by one or more of the following U.S. patents:	4,835,592	4,931,844	5,049,961	5,237,481	6,162,665	6,404,065 B1	6,683,344	6,727,585	7,005,734 B2	7,157,338B2
	4,850,072	5,017,508	5,063,307	5,381,025	6,259,123 B1	6,534,343	6,710,405 B2	6,759,692	7,063,975 B2	
	4,881,106	5,034,796	5,187,117	5,486,715	6,306,728 B1	6,583,505	6,710,463	6,771,478 B2	7,071,537	

**Fig. 1. Output Characteristics @ 25°C**

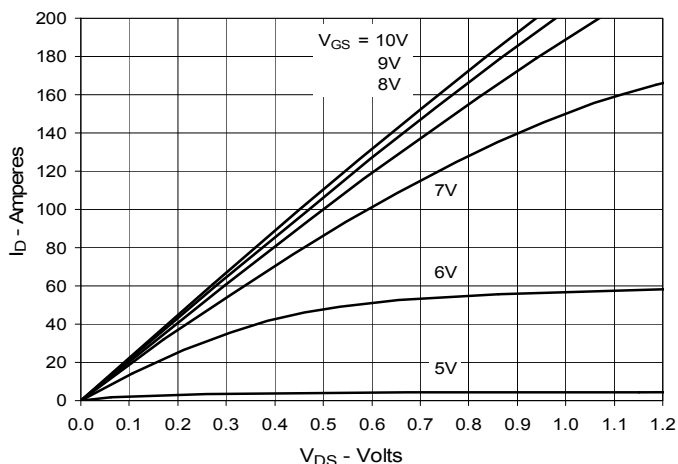

**Fig. 2. Extended Output Characteristics @ 25°C**

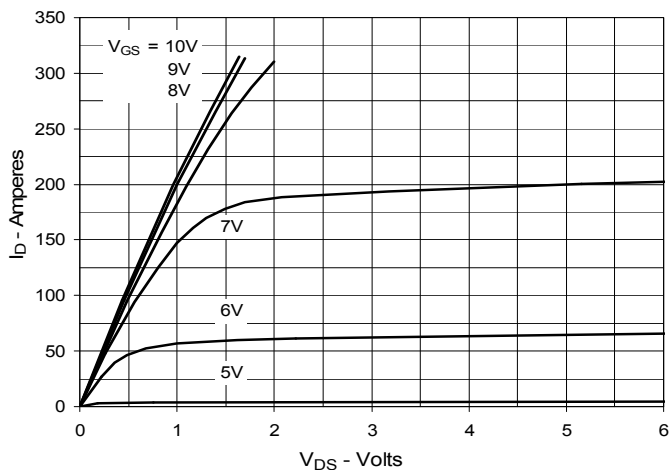

**Fig. 3. Output Characteristics @ 150°C**

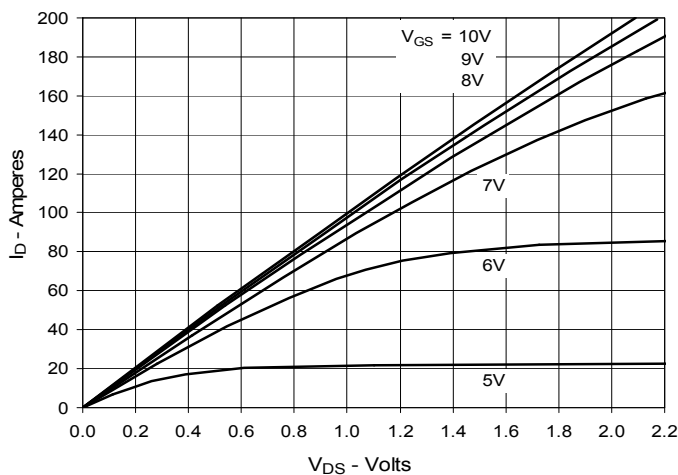

**Fig. 4.  $R_{DS(on)}$  Normalized to  $I_D = 100A$  Value vs. Junction Temperature**

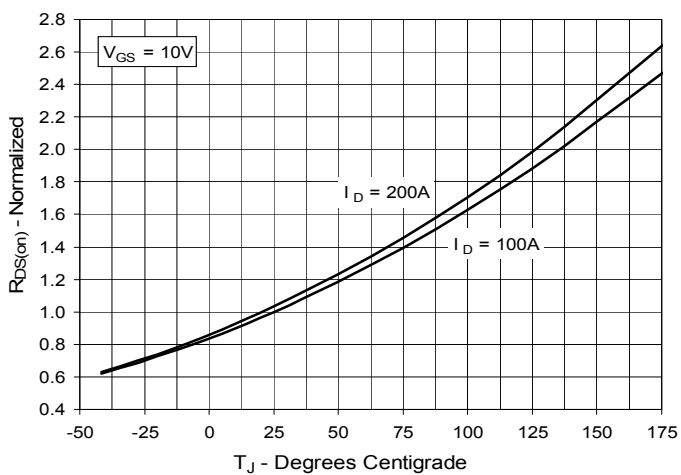

**Fig. 5.  $R_{DS(on)}$  Normalized to  $I_D = 100A$  Value vs. Drain Current**

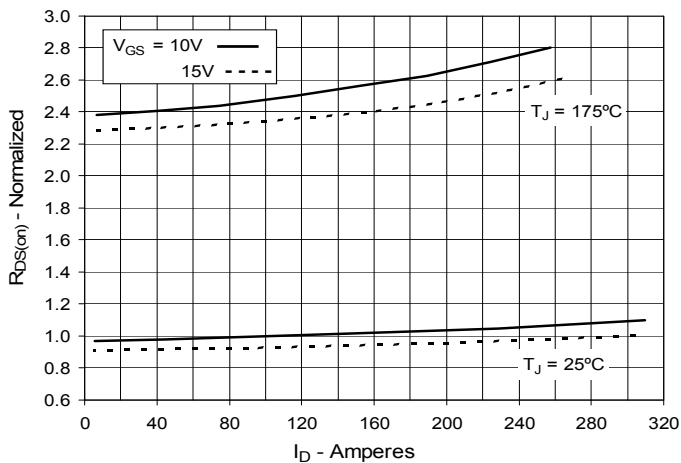

**Fig. 6. Drain Current vs. Case Temperature**

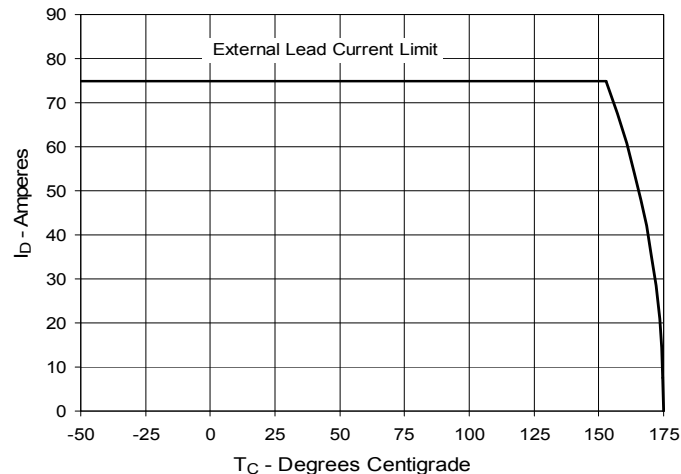

**Fig. 7. Input Admittance**

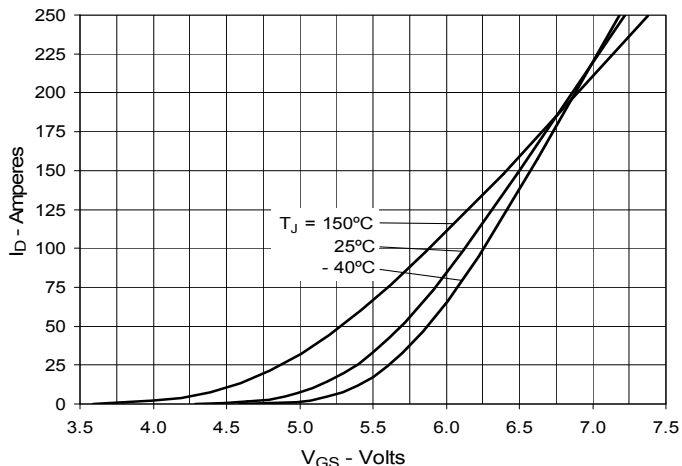

**Fig. 8. Transconductance**

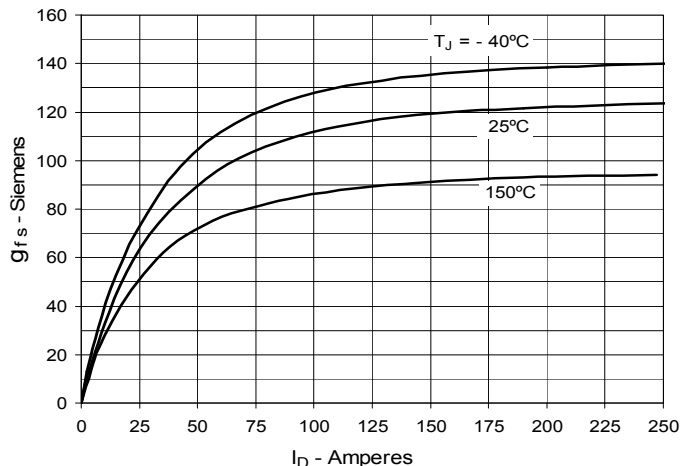

**Fig. 9. Forward Voltage Drop of Intrinsic Diode**

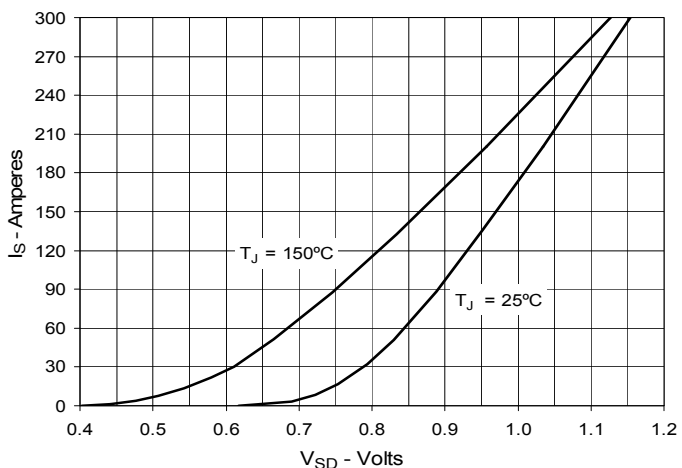

**Fig. 10. Gate Charge**

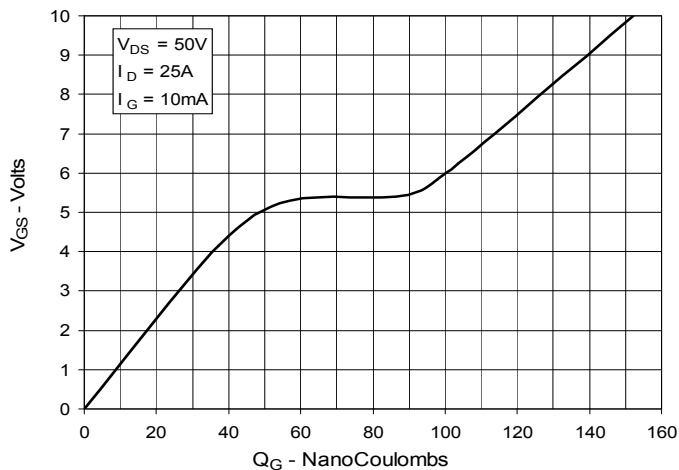

**Fig. 11. Capacitance**

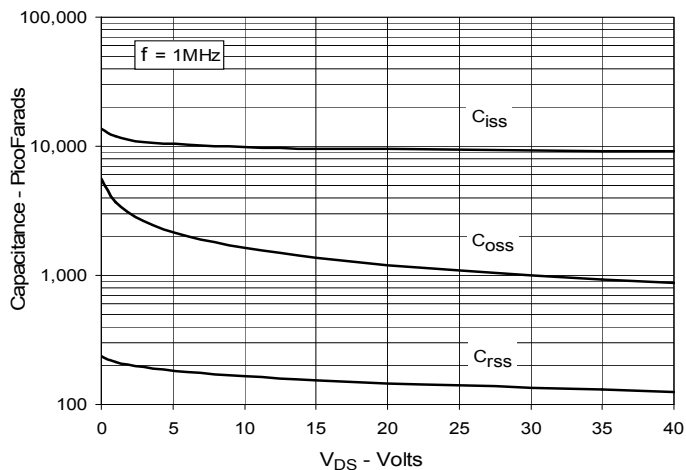

**Fig. 12. Maximum Transient Thermal Impedance**

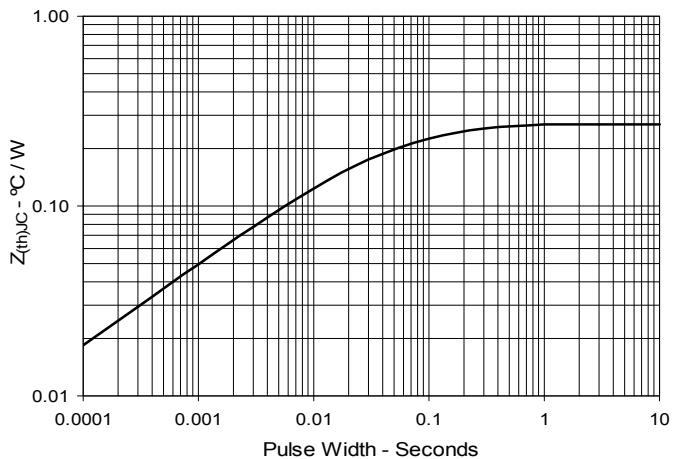

**Fig. 13. Resistive Turn-on Rise Time vs. Junction Temperature**

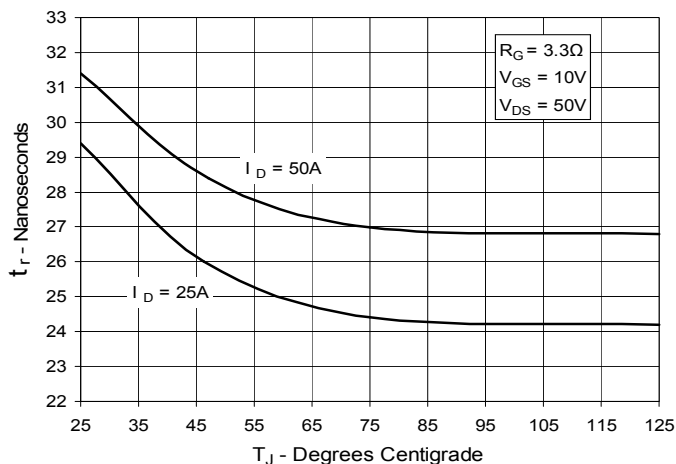

**Fig. 14. Resistive Turn-on Rise Time vs. Drain Current**

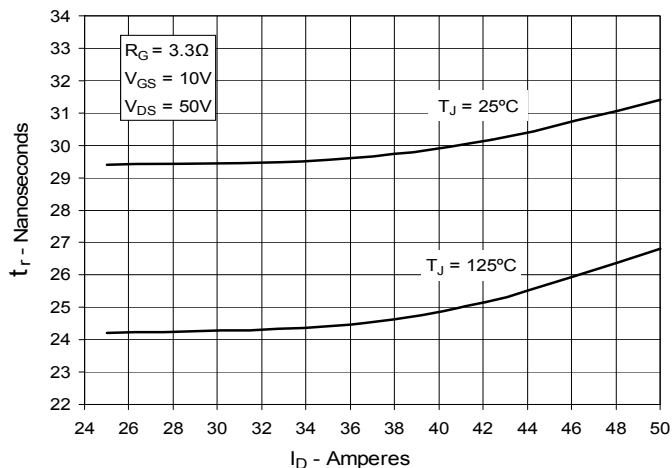

**Fig. 15. Resistive Turn-on Switching Times vs. Gate Resistance**

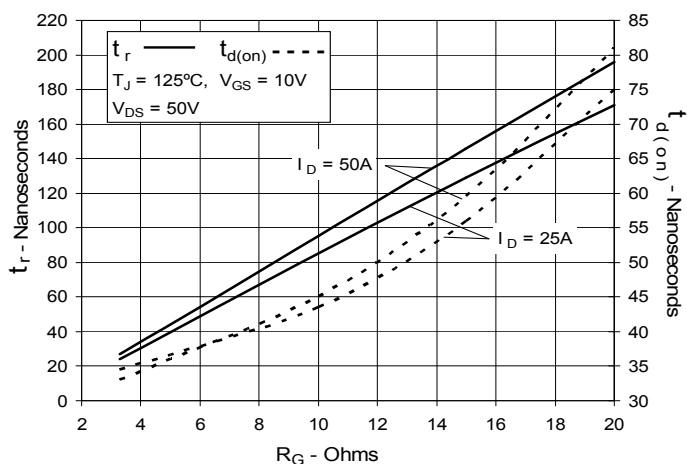

**Fig. 16. Resistive Turn-off Switching Times vs. Junction Temperature**

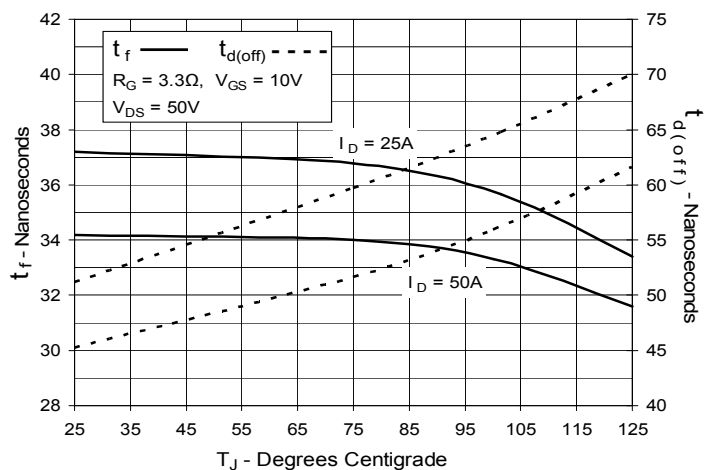

**Fig. 17. Resistive Turn-off Switching Times vs. Drain Current**

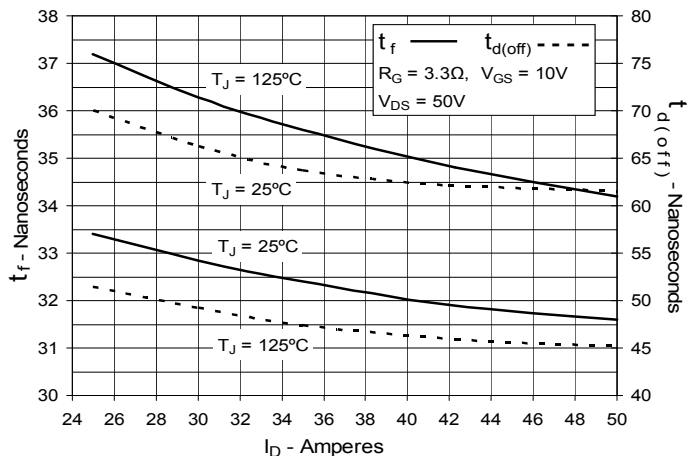

**Fig. 18. Resistive Turn-off Switching Times vs. Gate Resistance**

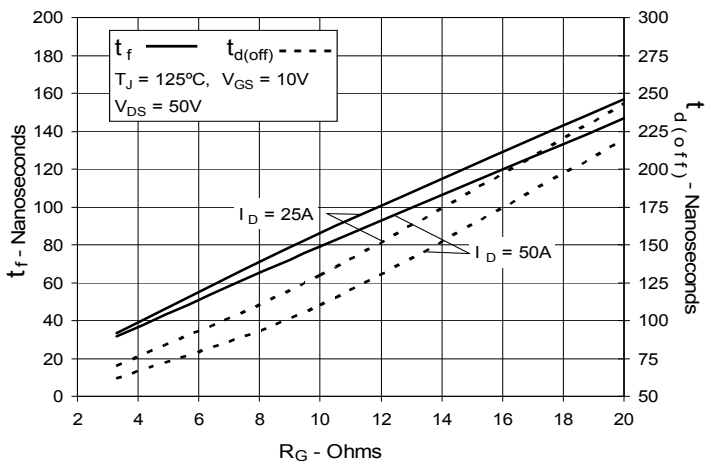



---

Disclaimer Notice - Information furnished is believed to be accurate and reliable. However, users should independently evaluate the suitability of and test each product selected for their own applications. Littelfuse products are not designed for, and may not be used in, all applications. Read complete Disclaimer Notice at [www.littelfuse.com/disclaimer-electronics](http://www.littelfuse.com/disclaimer-electronics).