

TrenchT2™ Power MOSFET

IXTA300N04T2 IXTP300N04T2

$V_{DSS} = 40V$
 $I_{D25} = 300A$
 $R_{DS(on)} \leq 2.5m\Omega$

N-Channel Enhancement Mode
 Avalanche Rated



TO-263 (IXTA)



TO-220 (IXTP)

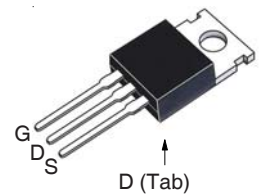

G = Gate D = Drain
 S = Source Tab = Drain

| Symbol | Test Conditions | Maximum Ratings | |
|---------------|---|--------------------|------------|
| V_{DSS} | $T_J = 25^\circ C$ to $175^\circ C$ | 40 | V |
| V_{DGR} | $T_J = 25^\circ C$ to $175^\circ C$, $R_{GS} = 1M\Omega$ | 40 | V |
| V_{GSM} | Transient | ± 20 | V |
| I_{D25} | $T_C = 25^\circ C$ | 300 | A |
| $I_{L(RMS)}$ | External Lead Current Limit | 120 | A |
| I_{DM} | $T_C = 25^\circ C$, Pulse Width Limited by T_{JM} | 900 | A |
| I_A | $T_C = 25^\circ C$ | 100 | A |
| E_{AS} | $T_C = 25^\circ C$ | 600 | mJ |
| P_D | $T_C = 25^\circ C$ | 480 | W |
| T_J | | -55 ... +175 | $^\circ C$ |
| T_{JM} | | 175 | $^\circ C$ |
| T_{stg} | | -55 ... +175 | $^\circ C$ |
| T_L | Maximum Lead Temperature for Soldering | 300 | $^\circ C$ |
| T_{SOLD} | 1.6 mm (0.062in.) from Case for 10s | 260 | $^\circ C$ |
| F_C | Mounting Force (TO-263) | 10..65 / 2.2..14.6 | N/lb |
| M_d | Mounting Torque (TO-220) | 1.13 / 10 | Nm/lb.in |
| Weight | TO-263 | 2.5 | g |
| | TO-220 | 3.0 | g |

Features

- International Standard Packages
- Avalanche Rated
- Low Package Inductance
- Fast Intrinsic Rectifier
- 175°C Operating Temperature
- High Current Handling Capability
- ROHS Compliant
- High Performance Trench Technology for extremely low $R_{DS(on)}$

Advantages

- High Power Density
- Easy to Mount
- Space Savings

Applications

- Automotive Engine Control
- Synchronous Buck Converter (for Notebook System Power & General Purpose Point & Load)
- DC/DC Converters
- High Current Switching Applications
- Power Train Management
- Distributed Power Architecture

| Symbol | Test Conditions ($T_J = 25^\circ C$ Unless Otherwise Specified) | Characteristic Values | | |
|--------------|---|-----------------------|------|--------------------------|
| | | Min. | Typ. | Max. |
| BV_{DSS} | $V_{GS} = 0V$, $I_D = 250\mu A$ | 40 | | V |
| $V_{GS(th)}$ | $V_{DS} = V_{GS}$, $I_D = 250\mu A$ | 2.0 | | V |
| I_{GSS} | $V_{GS} = \pm 20V$, $V_{DS} = 0V$ | | | ± 200 nA |
| I_{DSS} | $V_{DS} = V_{DSS}$, $V_{GS} = 0V$ $T_J = 150^\circ C$ | | | 5 μA 150 μA |
| $R_{DS(on)}$ | $V_{GS} = 10V$, $I_D = 150A$, Notes 1 & 2 | | | 2.5 m Ω |

| Symbol | Test Conditions ($T_J = 25^\circ\text{C}$ Unless Otherwise Specified) | Characteristic Values | | |
|--------------|---|-----------------------|------|-----------|
| | | Min. | Typ. | Max. |
| g_{fs} | $V_{DS} = 10\text{V}, I_D = 60\text{A}$, Note 1 | 55 | 94 | S |
| C_{iss} | $V_{GS} = 0\text{V}, V_{DS} = 25\text{V}, f = 1\text{MHz}$ | | 10.7 | nF |
| C_{oss} | | | 1630 | pF |
| C_{rss} | | | 263 | pF |
| $t_{d(on)}$ | Resistive Switching Times $V_{GS} = 10\text{V}, V_{DS} = 20\text{V}, I_D = 100\text{A}$ $R_G = 2\Omega$ (External) | | 22 | ns |
| t_r | | | 17 | ns |
| $t_{d(off)}$ | | | 32 | ns |
| t_f | | | 13 | ns |
| $Q_{g(on)}$ | $V_{GS} = 10\text{V}, V_{DS} = 0.5 \cdot V_{DSS}, I_D = 0.5 \cdot I_{DSS}$ | | 145 | nC |
| Q_{gs} | | | 44 | nC |
| Q_{gd} | | | 36 | nC |
| R_{thJC} | TO-220 | | 0.50 | 0.31 °C/W |
| R_{thCS} | | | | |

Source-Drain Diode

| Symbol | Test Conditions ($T_J = 25^\circ\text{C}$ Unless Otherwise Specified) | Characteristic Values | | |
|----------|---|-----------------------|------|--------|
| | | Min. | Typ. | Max. |
| I_s | $V_{GS} = 0\text{V}$ | | | 300 A |
| I_{SM} | Repetitive, Pulse Width Limited by T_{JM} | | | 1000 A |
| V_{SD} | $I_F = 100\text{A}, V_{GS} = 0\text{V}$, Note 1 | | | 1.1 V |
| t_{rr} | $I_F = 150\text{A}, V_{GS} = 0\text{V}$, $-di/dt = 100\text{A}/\mu\text{s}, V_R = 20\text{V}$ | | 53 | ns |
| I_{RM} | | | 1.8 | A |
| Q_{RM} | | | 47.7 | nC |

- Notes: 1. Pulse test, $t \leq 300\mu\text{s}$; duty cycle, $d \leq 2\%$.
 2. On through-hole packages, $R_{DS(on)}$ Kelvin test contact location must be 5mm or less from the package body.

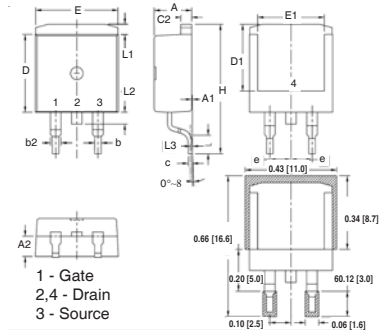
TO-263 Outline

| SYM | INCHES | | MILLIMETER | |
|------|----------|------|------------|-------|
| | MIN | MAX | MIN | MAX |
| A | .170 | .185 | 4.30 | 4.70 |
| A1 | .000 | .008 | 0.00 | 0.20 |
| A2 | .091 | .098 | 2.30 | 2.50 |
| b | .028 | .035 | 0.70 | 0.90 |
| b2 | .046 | .060 | 1.18 | 1.52 |
| C | .018 | .024 | 0.45 | 0.60 |
| C2 | .049 | .060 | 1.25 | 1.52 |
| D | .340 | .370 | 8.63 | 9.40 |
| D1 | .300 | .327 | 7.62 | 8.30 |
| E | .380 | .410 | 9.65 | 10.41 |
| E1 | .270 | .330 | 6.86 | 8.38 |
| (e) | .100 BSC | | 2.54 BSC | |
| H | .580 | .620 | 14.73 | 15.75 |
| L | .075 | .105 | 1.91 | 2.67 |
| L1 | .039 | .060 | 1.00 | 1.52 |
| L2 | — | .070 | — | 1.77 |
| (L3) | .010 BSC | | 0.254 BSC | |

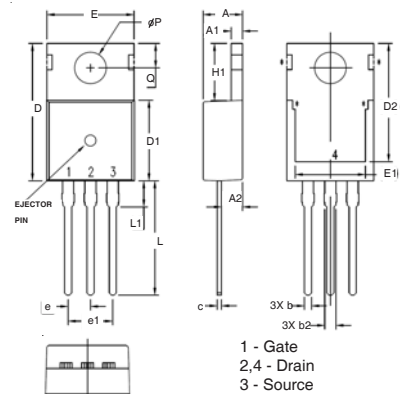
TO-220 Outline

| SYM | INCHES | | MILLIMETERS | |
|------|----------|------|-------------|-------|
| | MIN | MAX | MIN | MAX |
| A | .169 | .185 | 4.30 | 4.70 |
| A1 | .047 | .055 | 1.20 | 1.40 |
| A2 | .079 | .106 | 2.00 | 2.70 |
| b | .024 | .039 | 0.60 | 1.00 |
| b2 | .045 | .057 | 1.15 | 1.45 |
| c | .014 | .026 | 0.35 | 0.65 |
| D | .587 | .626 | 14.90 | 15.90 |
| D1 | .335 | .370 | 8.50 | 9.40 |
| (D2) | .500 | .531 | 12.70 | 13.50 |
| E | .382 | .406 | 9.70 | 10.30 |
| (E1) | .283 | .323 | 7.20 | 8.20 |
| e | .100 BSC | | 2.54 BSC | |
| e1 | .200 BSC | | 5.08 BSC | |
| H1 | .244 | .268 | 6.20 | 6.80 |
| L | .492 | .547 | 12.50 | 13.90 |
| L1 | .110 | .154 | 2.80 | 3.90 |
| ØP | .134 | .150 | 3.40 | 3.80 |
| Q | .106 | .126 | 2.70 | 3.20 |

IXYS Reserves the Right to Change Limits, Test Conditions, and Dimensions.

| | | | | | | | | | | |
|--|-----------|-----------|-----------|-----------|-------------|-------------|-------------|-------------|-------------|-------------|
| IXYS MOSFETs and IGBTs are covered by one or more of the following U.S. patents: | 4,835,592 | 4,931,844 | 5,049,961 | 5,237,481 | 6,162,665 | 6,404,065B1 | 6,683,344 | 6,727,585 | 7,005,734B2 | 7,157,338B2 |
| | 4,860,072 | 5,017,508 | 5,063,307 | 5,381,025 | 6,259,123B1 | 6,534,343 | 6,710,405B2 | 6,759,692 | 7,063,975B2 | |
| | 4,881,106 | 5,034,796 | 5,187,117 | 5,486,715 | 6,306,728B1 | 6,583,505 | 6,710,463 | 6,771,478B2 | 7,071,537 | |

Fig. 1. Output Characteristics @ $T_J = 25^\circ\text{C}$

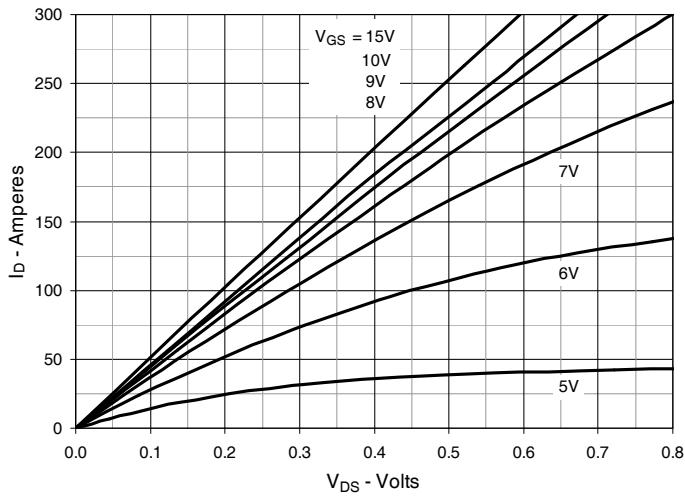

Fig. 2. Extended Output Characteristics @ $T_J = 25^\circ\text{C}$

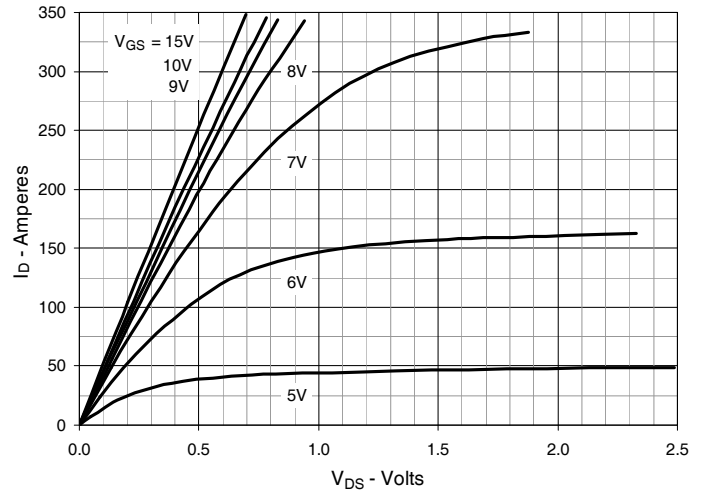

Fig. 3. Output Characteristics @ $T_J = 150^\circ\text{C}$

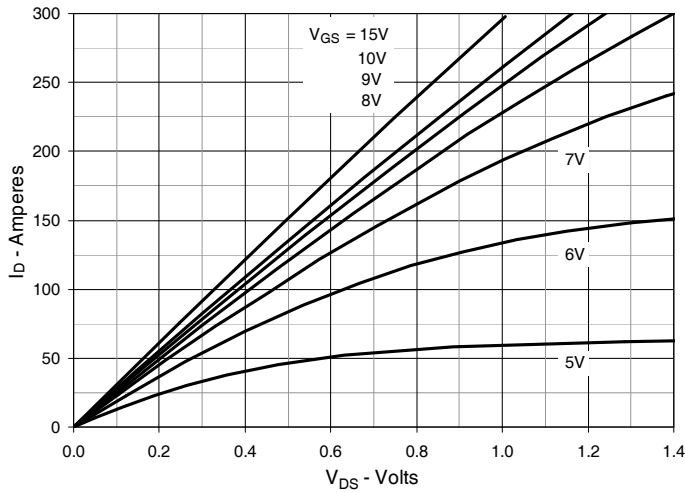

Fig. 4. $R_{DS(on)}$ Normalized to $I_D = 150\text{A}$ Value vs. Junction Temperature

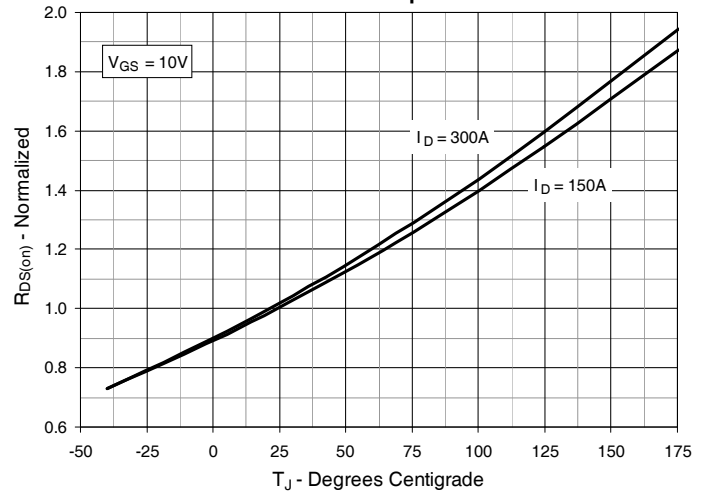

Fig. 5. $R_{DS(on)}$ Normalized to $I_D = 150\text{A}$ Value vs. Drain Current

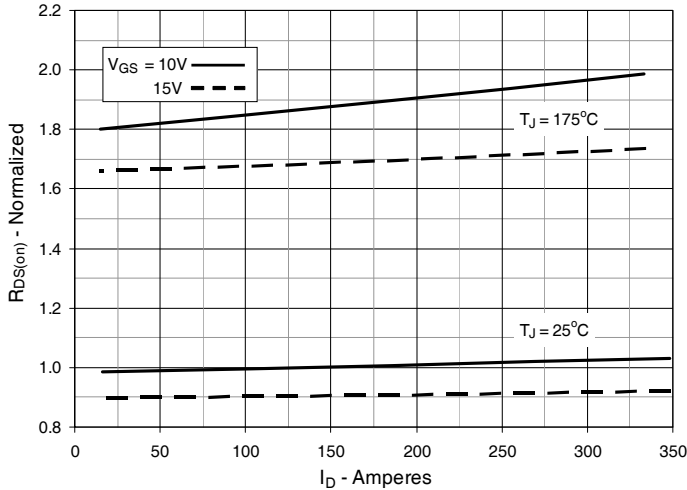

Fig. 6. Drain Current vs. Case Temperature

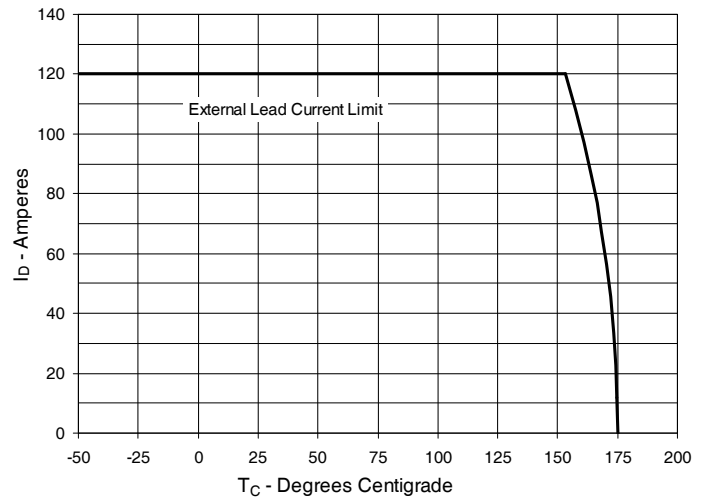

Fig. 7. Input Admittance

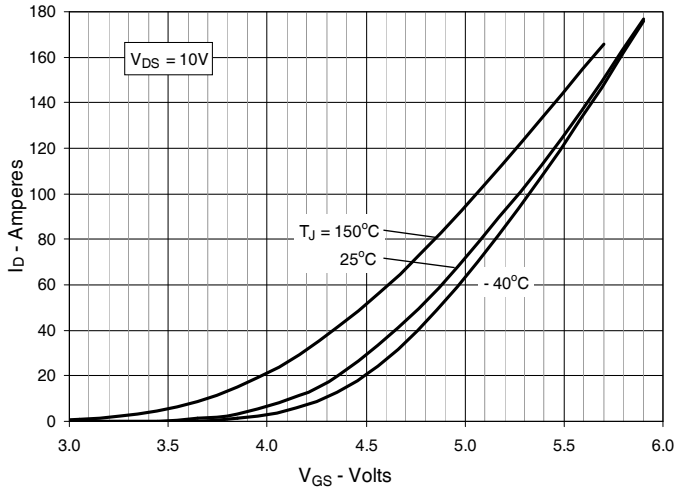

Fig. 8. Transconductance

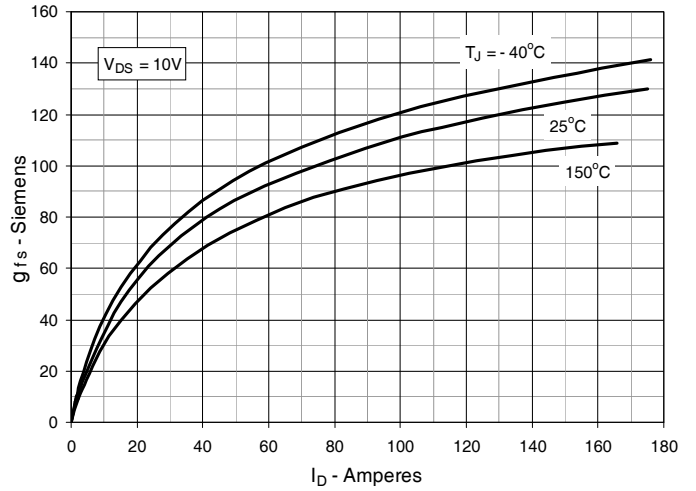

Fig. 9. Forward Voltage Drop of Intrinsic Diode

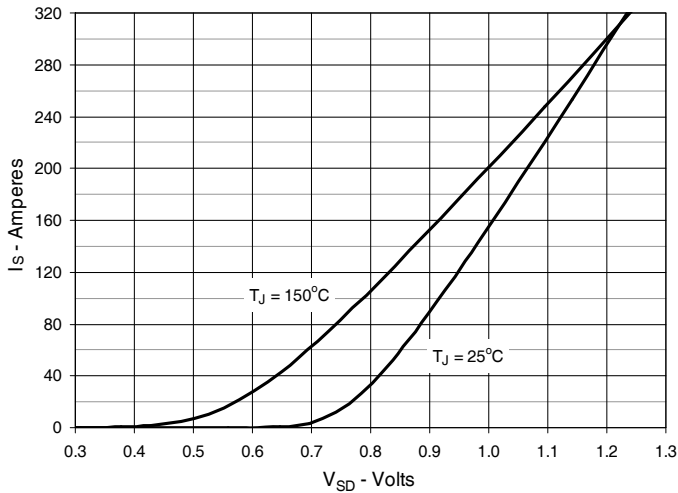

Fig. 10. Gate Charge

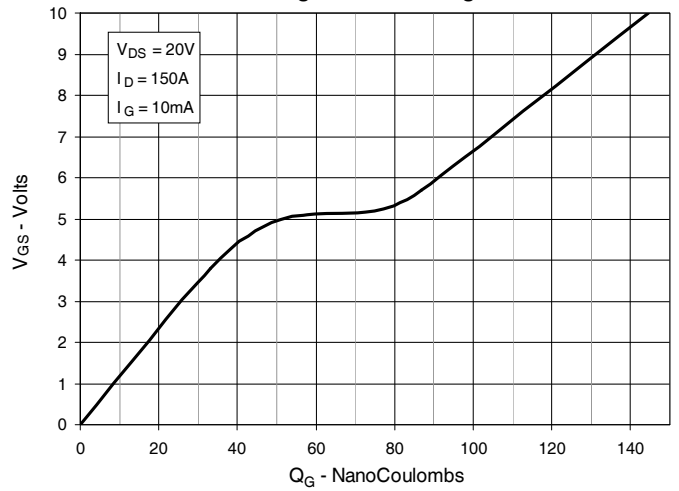

Fig. 11. Capacitance

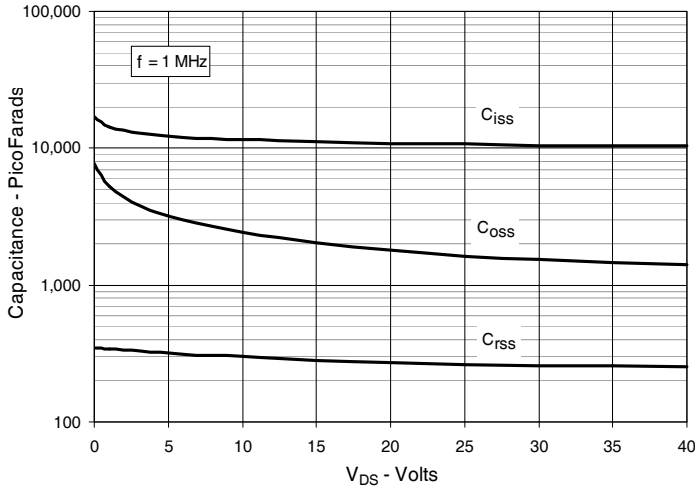

Fig. 12. Forward-Bias Safe Operating Area

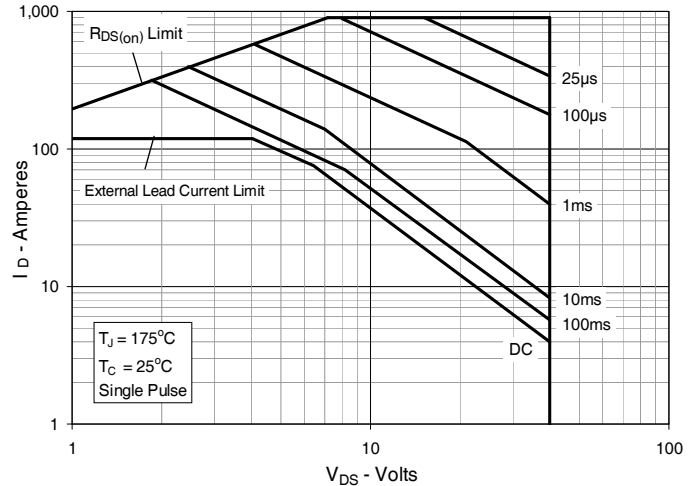

Fig. 13. Resistive Turn-on Rise Time vs. Junction Temperature

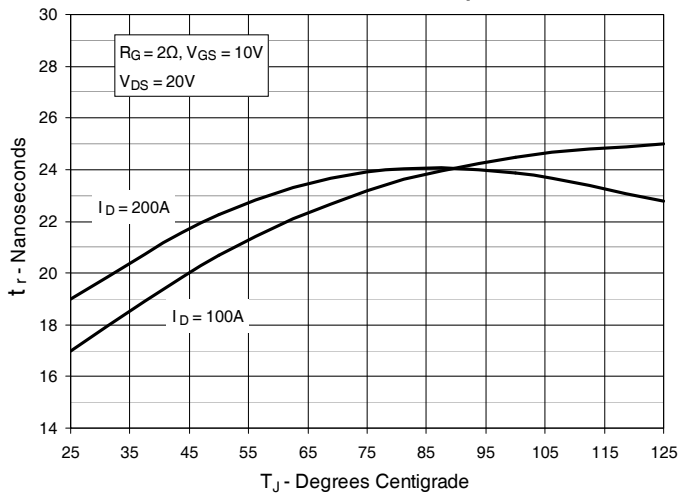

Fig. 14. Resistive Turn-on Rise Time vs. Drain Current

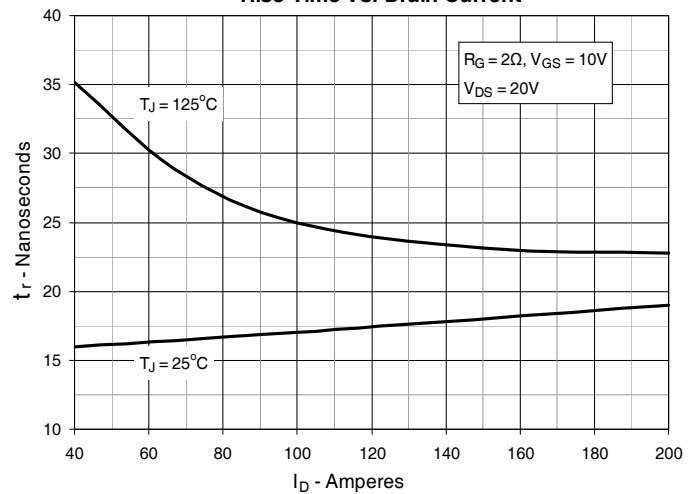

Fig. 15. Resistive Turn-on Switching Times vs. Gate Resistance

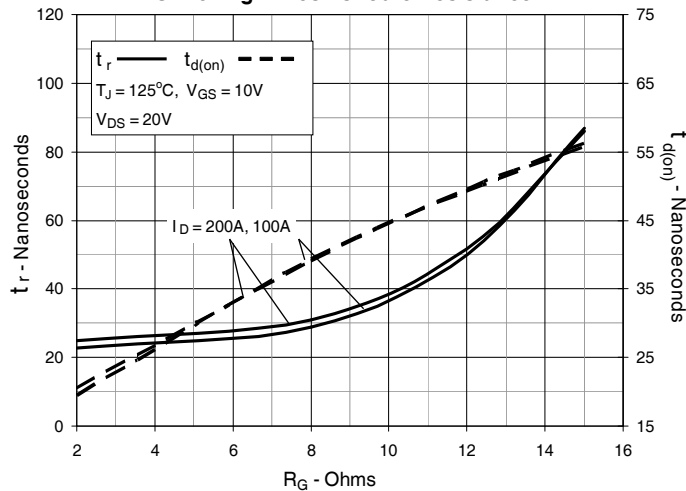

Fig. 16. Resistive Turn-off Switching Times vs. Junction Temperature

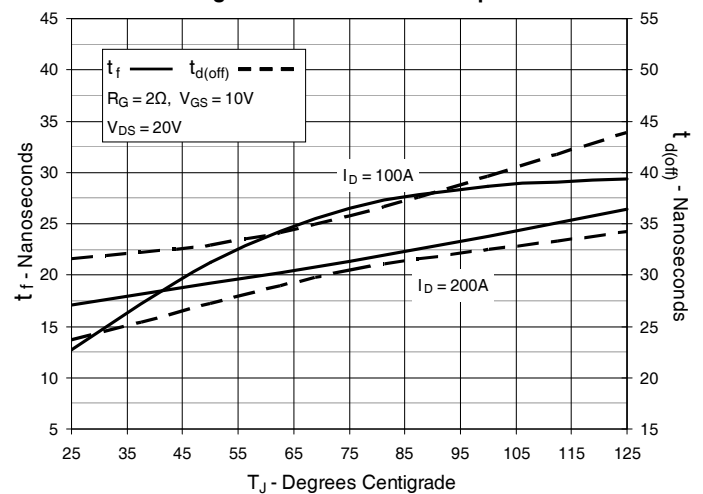

Fig. 17. Resistive Turn-off Switching Times vs. Drain Current

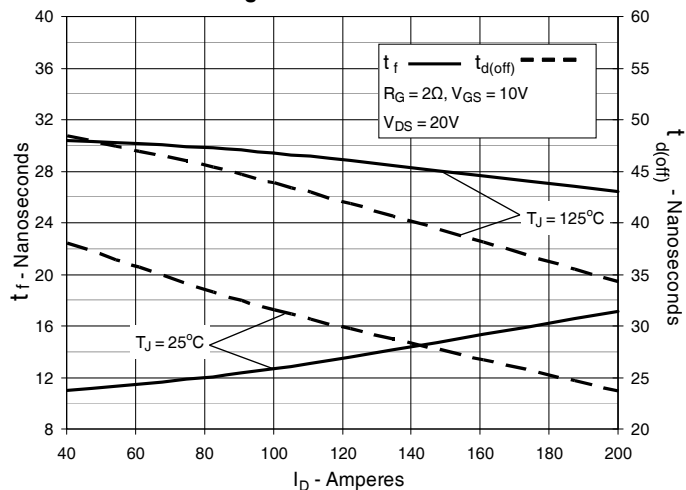

Fig. 18. Resistive Turn-off Switching Times vs. Gate Resistance

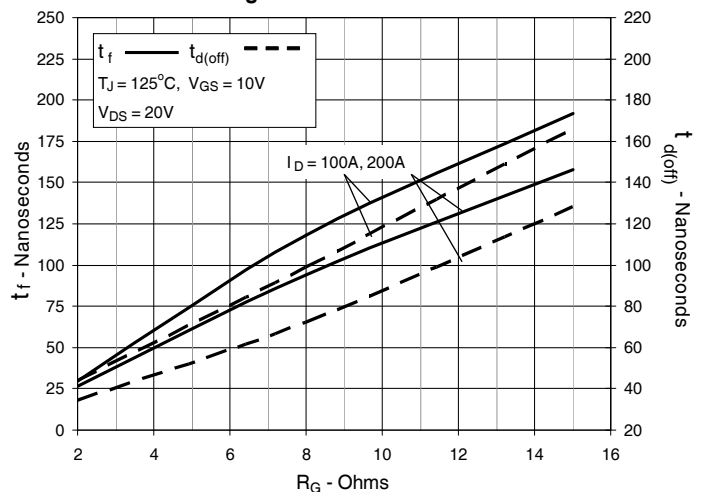
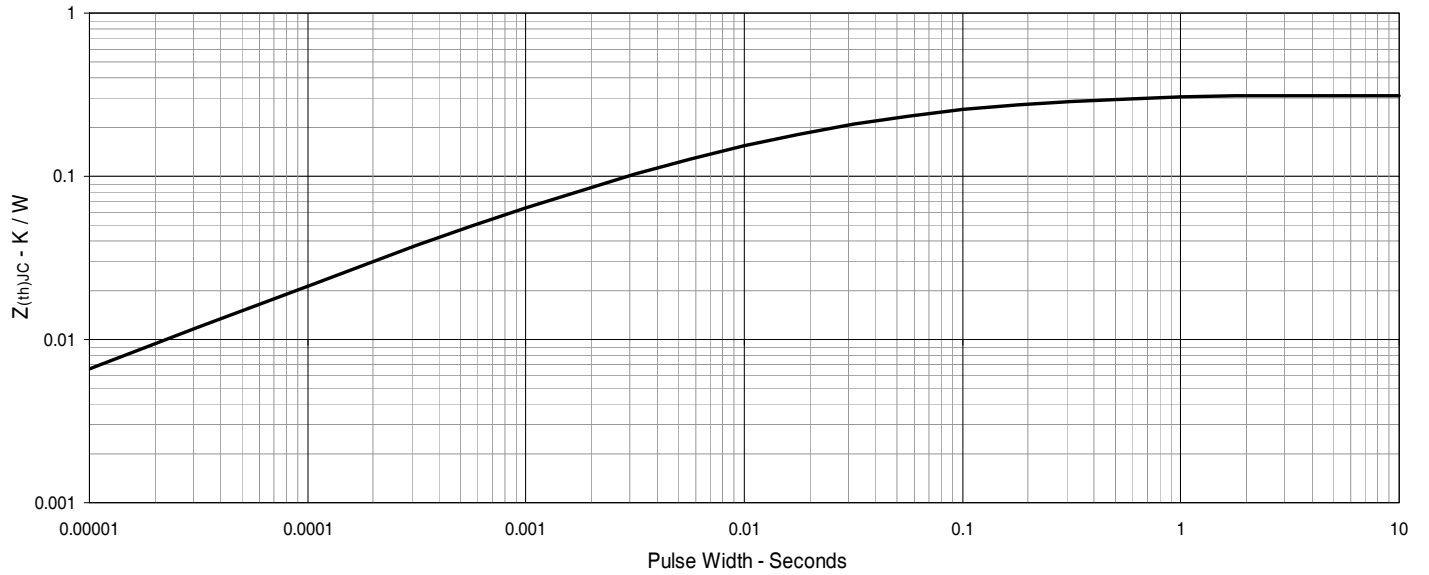

Fig. 19. Maximum Transient Thermal Impedance





Disclaimer Notice - Information furnished is believed to be accurate and reliable. However, users should independently evaluate the suitability of and test each product selected for their own applications. Littelfuse products are not designed for, and may not be used in, all applications. Read complete Disclaimer Notice at www.littelfuse.com/disclaimer-electronics.