

Trench Gate Power MOSFET

IXTH86N25T
IXTQ86N25T
IXTV86N25T

N-Channel Enhancement Mode
Avalanche Rated



Symbol	Test Conditions	Maximum Ratings	
V_{DSS}	$T_J = 25^\circ\text{C}$ to 150°C	250	V
V_{DGR}	$T_J = 25^\circ\text{C}$ to 150°C , $R_{GS} = 1\text{M}\Omega$	250	V
V_{GSM}	Transient	± 30	V
I_{D25}	$T_C = 25^\circ\text{C}$	86	A
I_{LRMS}	Lead Current Limit, RMS	75	A
I_{DM}	$T_C = 25^\circ\text{C}$, pulse width limited by T_{JM}	190	A
I_{AS}	$T_C = 25^\circ\text{C}$	10	A
E_{AS}	$T_C = 25^\circ\text{C}$	1.5	J
P_D	$T_C = 25^\circ\text{C}$	540	W
T_J		-55 ... +150	$^\circ\text{C}$
T_{JM}		150	$^\circ\text{C}$
T_{stg}		-55 ... +150	$^\circ\text{C}$
T_L	1.6mm (0.062 in.) from case for 10s	300	$^\circ\text{C}$
T_{SOLD}	Plastic body for 10 seconds	260	$^\circ\text{C}$
M_d	Mounting torque (TO-247 & TO-3P)	1.13 / 10	Nm/lb.in.
F_C	Mounting force (PLUS220)	11..65 / 2.5..14.6	N/lb.
Weight	TO-247	6.0	g
	TO-3P	5.5	g
	PLUS220	4.0	g

Symbol	Test Conditions ($T_J = 25^\circ\text{C}$ unless otherwise specified)	Characteristic Values		
		Min.	Typ.	Max.
BV_{DSS}	$V_{GS} = 0\text{V}$, $I_D = 250\mu\text{A}$	250		V
$V_{GS(th)}$	$V_{DS} = V_{GS}$, $I_D = 1\text{mA}$	3		5 V
I_{GSS}	$V_{GS} = \pm 20\text{V}$, $V_{DS} = 0\text{V}$			± 200 nA
I_{DSS}	$V_{DS} = V_{DSS}$			3 μA
	$V_{GS} = 0\text{V}$ $T_J = 125^\circ\text{C}$			250 μA
$R_{DS(on)}$	$V_{GS} = 10\text{V}$, $I_D = 0.5 \cdot I_{D25}$, Notes 1, 2			37 m Ω

$V_{DSS} = 250\text{V}$
 $I_{D25} = 86\text{A}$
 $R_{DS(on)} \leq 37\text{m}\Omega$

TO-247 (IXTH)

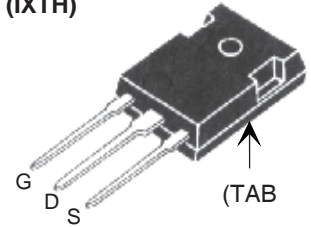

TO-3P (IXTQ)

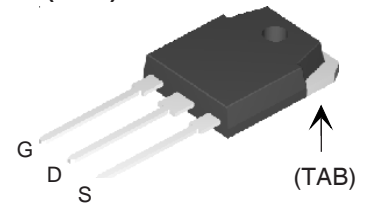

PLUS220 (IXTV)

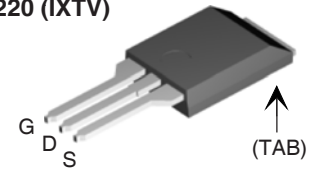

G = Gate D = Drain
S = Source TAB = Drain

Features

- International standard packages
- Avalanche rated
- Low package inductance
 - easy to drive and to protect

Advantages

- Easy to mount
- Space savings
- High power density

Applications

- DC-DC converters
- Battery chargers
- Switched-mode and resonant-mode power supplies
- DC choppers
- AC motor control
- Uninterruptible power supplies

Symbol	Test Conditions	Characteristic Values		
		Min.	Typ.	Max.
$(T_J = 25^\circ\text{C unless otherwise specified})$				
g_{fs}	$V_{DS} = 10\text{V}, I_D = 0.5 \cdot I_{D25}$, Note 1	45	76	S
C_{iss}	$V_{GS} = 0\text{V}, V_{DS} = 25\text{V}, f = 1\text{MHz}$		5330	pF
C_{oss}			515	pF
C_{rss}			92	pF
$t_{d(on)}$	Resistive Switching Times $V_{GS} = 10\text{V}, V_{DS} = 0.5 \cdot V_{DSS}, I_D = 0.5 \cdot I_{D25}$ $R_G = 3.3\Omega$ (External)		22	ns
t_r			28	ns
$t_{d(off)}$			55	ns
t_f			25	ns
$Q_{g(on)}$	$V_{GS} = 10\text{V}, V_{DS} = 0.5 \cdot V_{DSS}, I_D = 25\text{A}$		105	nC
Q_{gs}			32	nC
Q_{gd}			28	nC
R_{thJC}			0.23	$^\circ\text{C/W}$
R_{thCS}			0.25	$^\circ\text{C/W}$

Source-Drain Diode

Symbol	Test Conditions	Characteristic Values		
		Min.	Typ.	Max.
$T_J = 25^\circ\text{C unless otherwise specified}$				
I_S	$V_{GS} = 0\text{V}$			86 A
I_{SM}	Repetitive, pulse width limited by T_{JM}			172 A
V_{SD}	$I_F = I_S, V_{GS} = 0\text{V}$, Note 1			1.5 V
t_{rr}	$I_F = 43\text{A}, -di/dt = 250\text{A}/\mu\text{s}$ $V_R = 100\text{V}, V_{GS} = 0\text{V}$		156	ns
I_{RM}			21	A
Q_{RM}			1.7	μC

- Notes: 1. Pulse test, $t \leq 300\text{ms}$; duty cycle, $d \leq 2\%$.
2. On through-hole packages, $R_{DS(on)}$ Kelvin test contact location must be 5mm or less from the package body.

TO-247AD Outline

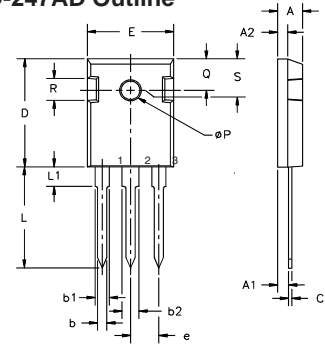

Terminals: 1 - Gate 2 - Drain
3 - Source Tab - Drain

Dim.	Millimeter		Inches	
	Min.	Max.	Min.	Max.
A	4.7	5.3	.185	.209
A ₁	2.2	2.54	.087	.102
A ₂	2.2	2.6	.059	.098
b	1.0	1.4	.040	.055
b ₁	1.65	2.13	.065	.084
b ₂	2.87	3.12	.113	.123
C	.4	.8	.016	.031
D	20.80	21.46	.819	.845
E	15.75	16.26	.610	.640
e	5.20	5.72	0.205	0.225
L	19.81	20.32	.780	.800
L1		4.50		.177
∅EP	3.55	3.65	.140	.144
Q	5.89	6.40	0.232	0.252
R	4.32	5.49	.170	.216
S	6.15	BSC	242	BSC

TO-3P (IXTQ) Outline

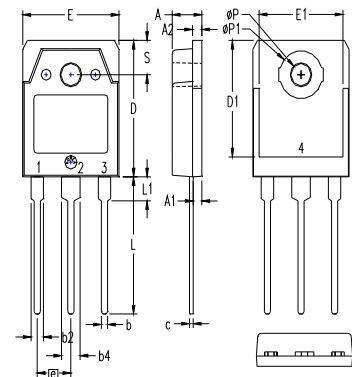

Pins: 1 - Gate 2 - Drain
3 - Source 4, TAB - Drain

SYM	INCHES		MILLIMETERS	
	MIN	MAX	MIN	MAX
A	.185	.193	4.70	4.90
A1	.051	.059	1.30	1.50
A2	.057	.065	1.45	1.65
b	.035	.045	0.90	1.15
b2	.075	.087	1.90	2.20
b4	.114	.126	2.90	3.20
c	.022	.031	0.55	0.80
D	.780	.791	19.80	20.10
D1	.665	.677	16.90	17.20
E	.610	.622	15.50	15.80
E1	.531	.539	13.50	13.70
e		215 BSC		5.45 BSC
L	.779	.795	19.80	20.20
L1	.134	.142	3.40	3.60
L2	.035	.051	0.90	1.30
L3	.047	.059	1.20	1.50
∅P	.126	.134	3.20	3.40
∅P1	.272	.280	6.90	7.10
S	.193	.201	4.90	5.10

All metal area ore tin plated.

PLUS220 (IXTV) Outline

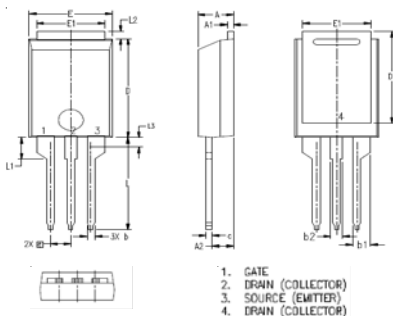

SYM	INCHES		MILLIMETER	
	MIN	MAX	MIN	MAX
A	.169	.185	4.30	4.70
A1	.028	.035	0.70	0.90
A2	.098	.118	2.50	3.00
b	.035	.047	0.90	1.20
b1	.080	.095	2.03	2.41
b2	.054	.064	1.37	1.63
c	.028	.035	0.70	0.90
D	.551	.591	14.00	15.00
D1	.512	.539	13.00	13.70
E	.394	.433	10.00	11.00
E1	.331	.346	8.40	8.80
e		.100 BSC		2.54 BSC
L	.512	.551	13.00	14.00
L1	.118	.138	3.00	3.50
L2	.035	.051	0.90	1.30
L3	.047	.059	1.20	1.50

PRELIMINARY TECHNICAL INFORMATION

The product presented herein is under development. The Technical Specifications offered are derived from data gathered during objective characterizations of preliminary engineering lots; but also may yet contain some information supplied during a pre-production design evaluation. IXYS reserves the right to change limits, test conditions, and dimensions without notice.

IXYS reserves the right to change limits, test conditions, and dimensions.

IXYS MOSFETs and IGBTs are covered by one or more of the following U.S. patents:	4,835,592	4,931,844	5,049,961	5,237,481	6,162,665	6,404,065 B1	6,683,344	6,727,585	7,005,734 B2	7,157,338B2
	4,850,072	5,017,508	5,063,307	5,381,025	6,259,123 B1	6,534,343	6,710,405 B2	6,759,692	7,063,975 B2	
	4,881,106	5,034,796	5,187,117	5,486,715	6,306,728 B1	6,583,505	6,710,463	6,771,478 B2	7,071,537	

Fig. 1. Output Characteristics @ 25°C

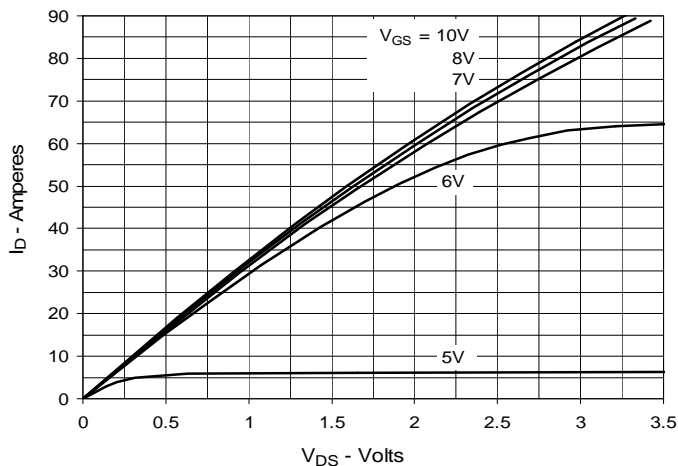

Fig. 2. Extended Output Characteristics @ 25°C

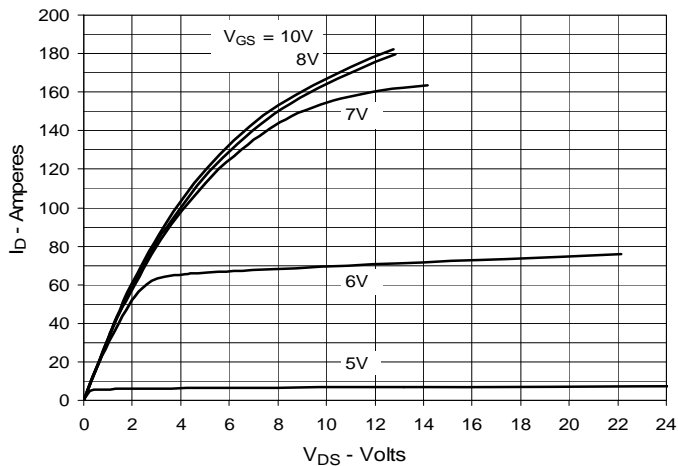

Fig. 3. Output Characteristics @ 125°C

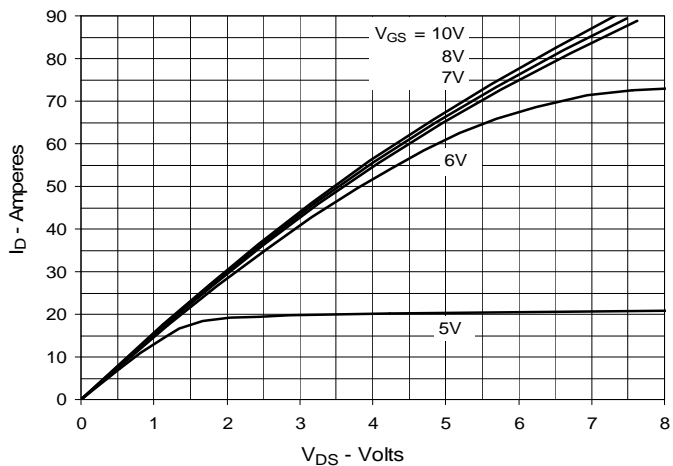

Fig. 4. $R_{DS(on)}$ Normalized to $I_D = 43A$ Value vs. Junction Temperature

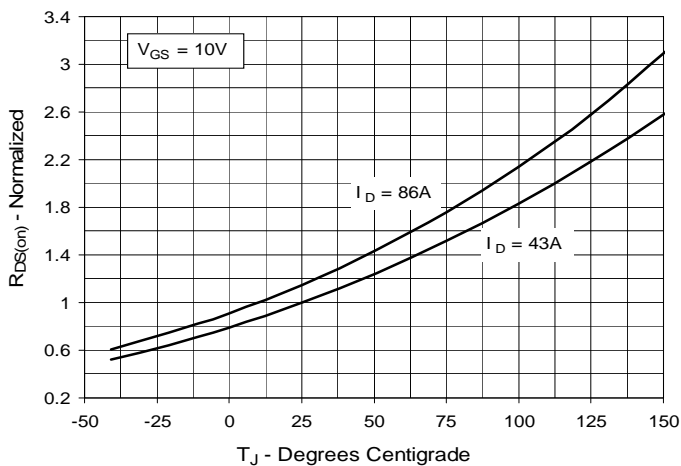

Fig. 5. $R_{DS(on)}$ Normalized to $I_D = 43A$ Value vs. Drain Current

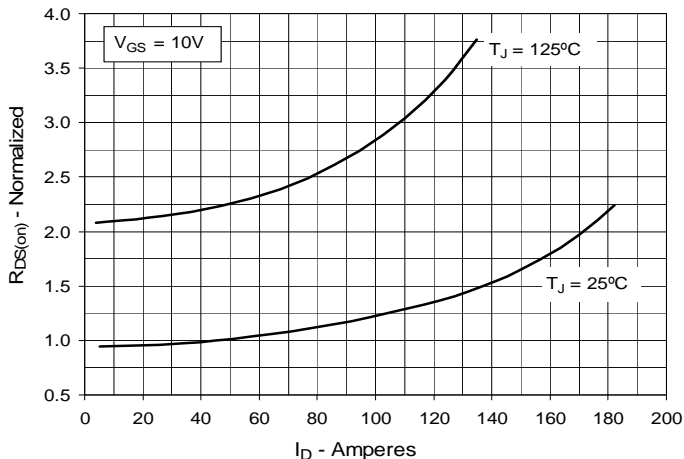

Fig. 6. Maximum Drain Current vs. Case Temperature

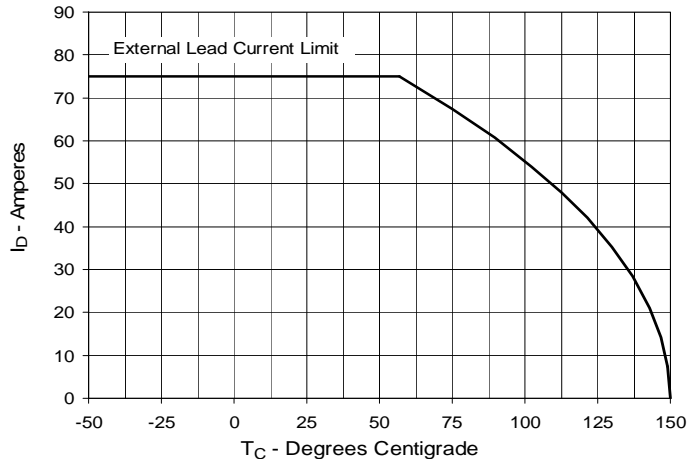

Fig. 7. Input Admittance

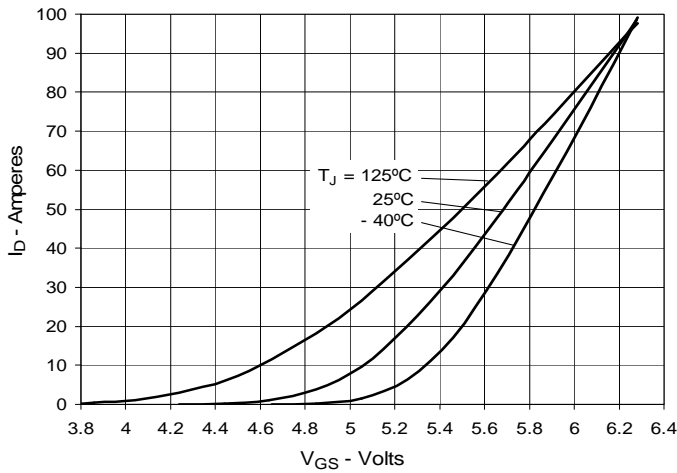

Fig. 8. Transconductance

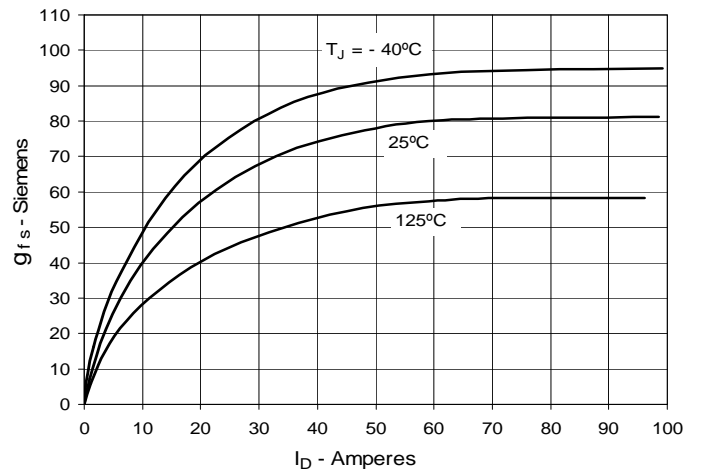

Fig. 9. Forward Voltage Drop of Intrinsic Diode

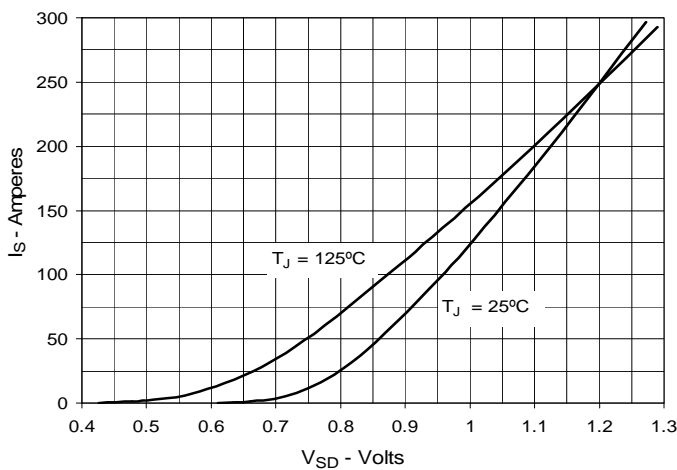

Fig. 10. Gate Charge

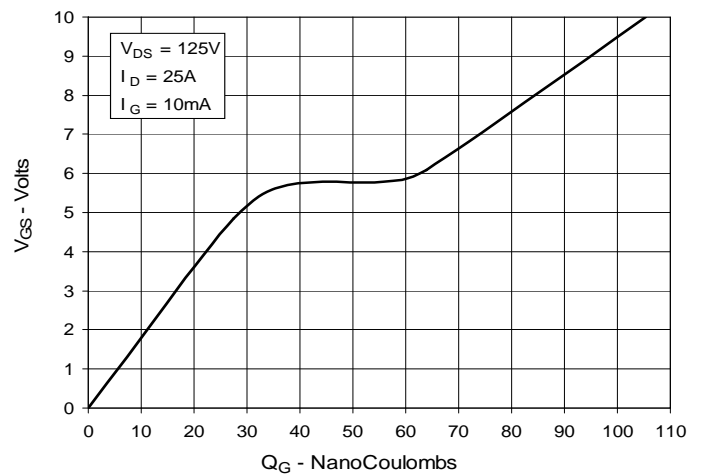

Fig. 11. Capacitance

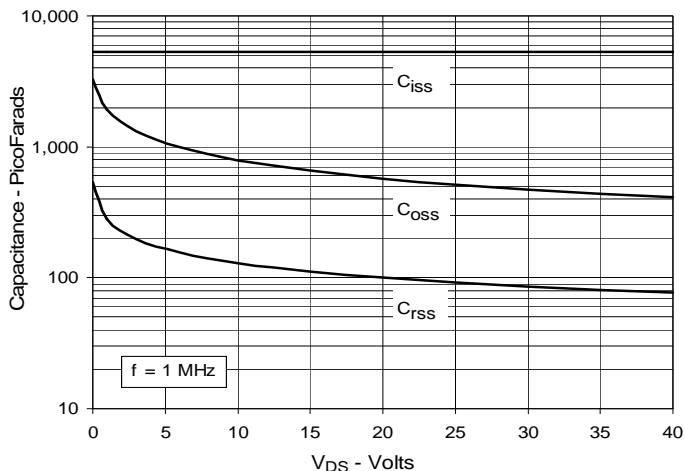
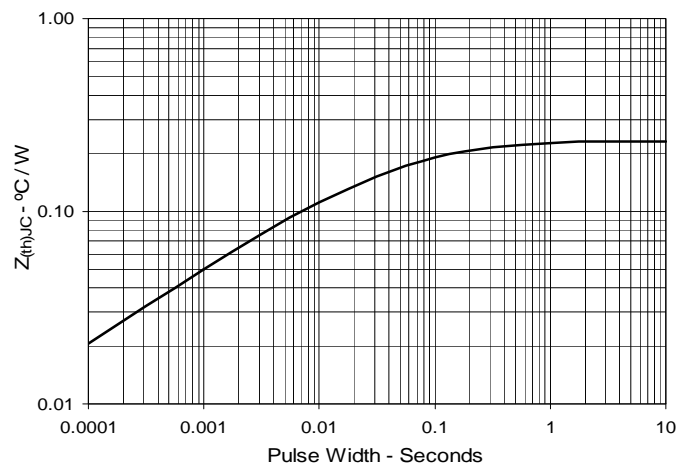
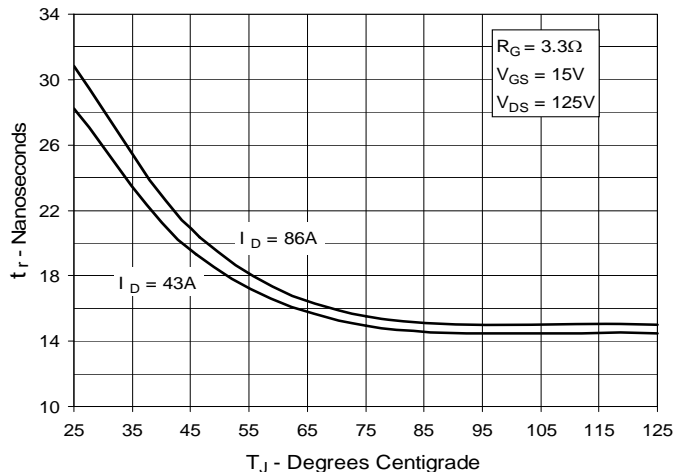

Fig. 12. Maximum Transient Thermal Impedance



**Fig. 13. Resistive Turn-on
Rise Time vs. Junction Temperature**



**Fig. 14. Resistive Turn-on
Rise Time vs. Drain Current**

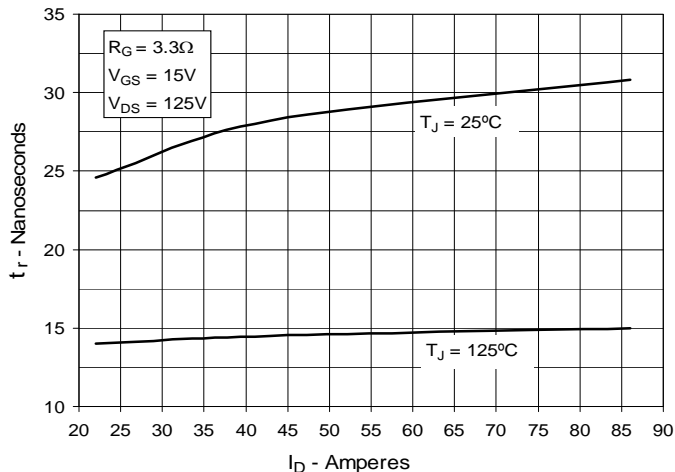

**Fig. 15. Resistive Turn-on
Switching Times vs. Gate Resistance**

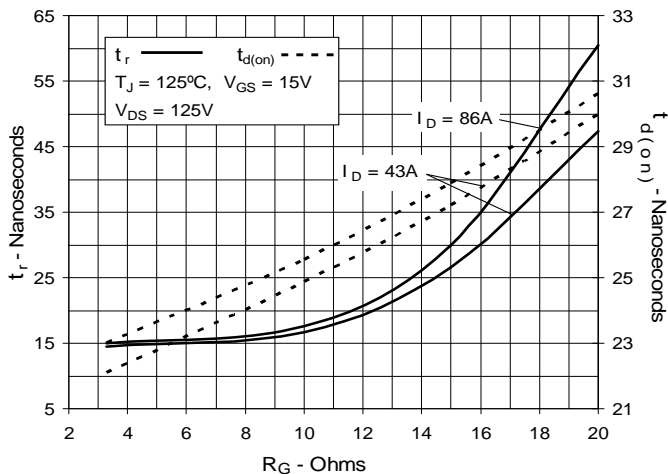

**Fig. 16. Resistive Turn-off
Switching Times vs. Junction Temperature**

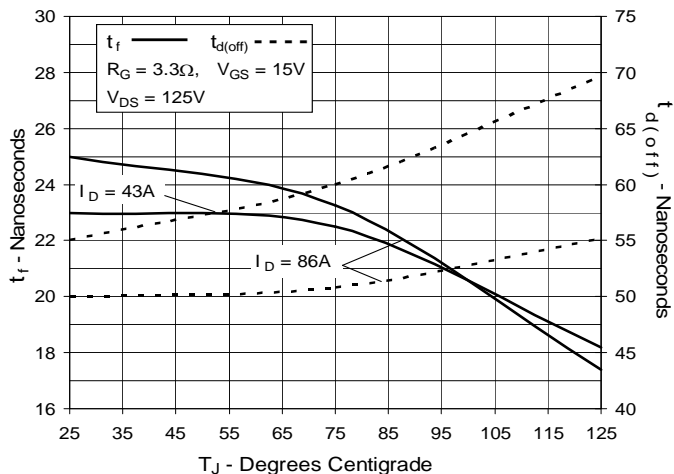

**Fig. 17. Resistive Turn-off
Switching Times vs. Drain Current**

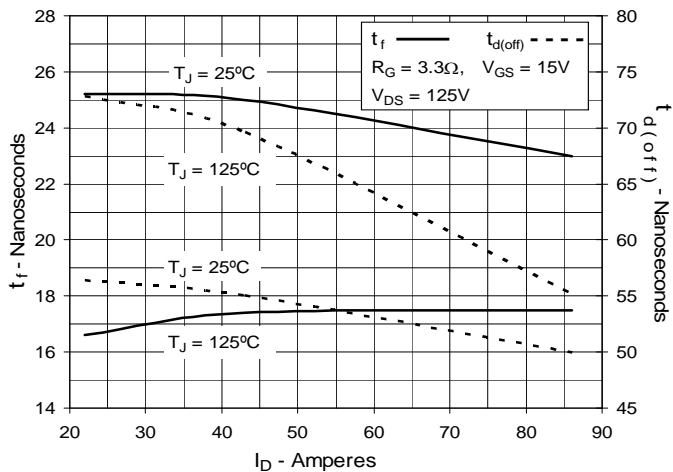

**Fig. 18. Resistive Turn-off
Switching Times vs. Gate Resistance**

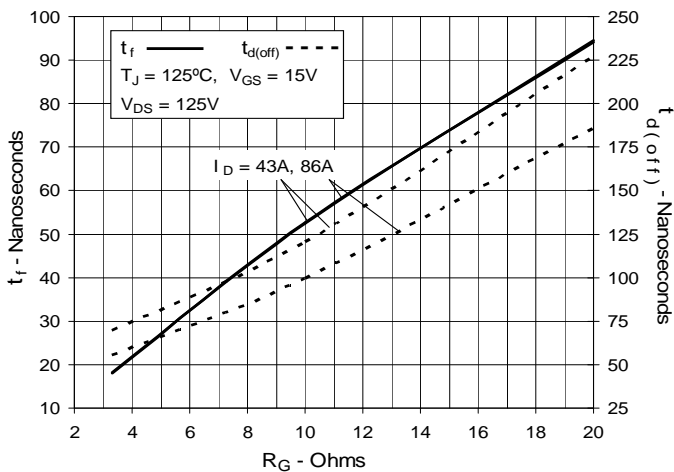



Disclaimer Notice - Information furnished is believed to be accurate and reliable. However, users should independently evaluate the suitability of and test each product selected for their own applications. Littelfuse products are not designed for, and may not be used in, all applications. Read complete Disclaimer Notice at www.littelfuse.com/disclaimer-electronics.