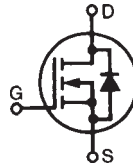

**X3-Class HiPerFET™  
Power MOSFET**
**IXFT170N15X3HV  
IXFQ170N15X3  
IXFH170N15X3**
 $V_{DSS} = 150V$   
 $I_{D25} = 170A$   
 $R_{DS(on)} \leq 6.7m\Omega$ 

 N-Channel Enhancement Mode  
 Avalanche Rated

| Symbol        | Test Conditions  | Maximum Ratings |            |
|---------------|--|-----------------|------------|
| $V_{DSS}$     | $T_J = 25^\circ C$ to $150^\circ C$                                | 150             | V          |
| $V_{DGR}$     | $T_J = 25^\circ C$ to $150^\circ C$ , $R_{GS} = 1M\Omega$          | 150             | V          |
| $V_{GSS}$     | Continuous   | $\pm 20$        | V          |
| $V_{GSM}$     | Transient  | $\pm 30$        | V          |
| $I_{D25}$     | $T_C = 25^\circ C$   | 170             | A          |
| $I_{L(RMS)}$  | External Lead Current Limit  | 160             | A          |
| $I_{DM}$      | $T_C = 25^\circ C$ , Pulse Width Limited by $T_{JM}$               | 340             | A          |
| $I_A$         | $T_C = 25^\circ C$   | 85              | A          |
| $E_{AS}$      | $T_C = 25^\circ C$   | 1.7             | J          |
| $dv/dt$       | $I_S \leq I_{DM}$ , $V_{DD} \leq V_{DSS}$ , $T_J \leq 150^\circ C$ | 20              | V/ns       |
| $P_D$         | $T_C = 25^\circ C$   | 520             | W          |
| $T_J$         |  | -55 ... +150    | $^\circ C$ |
| $T_{JM}$      |  | 150             | $^\circ C$ |
| $T_{stg}$     |  | -55 ... +150    | $^\circ C$ |
| $T_L$         | Maximum Lead Temperature for Soldering                             | 300             | $^\circ C$ |
| $T_{SOLD}$    | 1.6 mm (0.062in.) from Case for 10s                                | 260             | $^\circ C$ |
| $M_d$         | Mounting Torque (TO-247 & TO-3P)                                   | 1.13 / 10       | Nm/lb.in   |
| <b>Weight</b> | TO-268HV   | 4.0             | g          |
|               | TO-3P  | 5.5             | g          |
|               | TO-247   | 6.0             | g          |

| Symbol       | Test Conditions<br>( $T_J = 25^\circ C$ , Unless Otherwise Specified) | Characteristic Values |      |                           |
|--------------|---|-----------------------|------|---------------------------|
|              |   | Min.                  | Typ. | Max.                      |
| $BV_{DSS}$   | $V_{GS} = 0V$ , $I_D = 1mA$   | 150                   |      | V                         |
| $V_{GS(th)}$ | $V_{DS} = V_{GS}$ , $I_D = 4mA$                                       | 2.5                   |      | 4.5 V                     |
| $I_{GSS}$    | $V_{GS} = \pm 20V$ , $V_{DS} = 0V$                                    |                       |      | $\pm 100$ nA              |
| $I_{DSS}$    | $V_{DS} = V_{DSS}$ , $V_{GS} = 0V$<br>$T_J = 125^\circ C$             |                       |      | 10 $\mu A$<br>300 $\mu A$ |
| $R_{DS(on)}$ | $V_{GS} = 10V$ , $I_D = 0.5 \cdot I_{D25}$ , Note 1                   | 5.7                   | 6.7  | $m\Omega$                 |

TO-268HV (IXFT..HV)

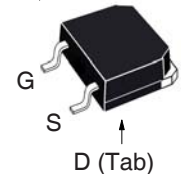

TO-3P (IXFQ)

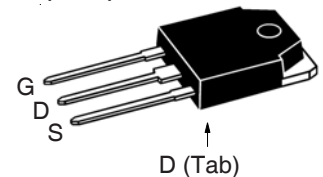

TO-247 (IXFH)

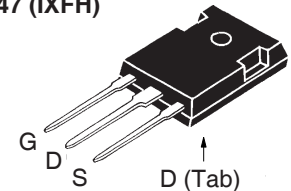
 G = Gate      D = Drain  
 S = Source    Tab = Drain

**Features**

- International Standard Packages
- Low  $R_{DS(ON)}$  and  $Q_G$
- Avalanche Rated
- Low Package Inductance

**Advantages**

- High Power Density
- Easy to Mount
- Space Savings

**Applications**

- Switch-Mode and Resonant-Mode Power Supplies
- DC-DC Converters
- PFC Circuits
- AC and DC Motor Drives
- Robotics and Servo Controls

| Symbol                              | Test Conditions<br>( $T_J = 25^\circ\text{C}$ , Unless Otherwise Specified)  | Characteristic Values                                |      |                         |
|-------------------------------------|--|--|------|-------------------------|
|                                     |  | Min.   | Typ. | Max                     |
| $g_{fs}$                            | $V_{DS} = 10\text{V}$ , $I_D = 60\text{A}$ , Note 1  | 54   | 90   | S                       |
| $R_{Gi}$                            | Gate Input Resistance  |  | 1.5  | $\Omega$                |
| $C_{iss}$                           | $V_{GS} = 0\text{V}$ , $V_{DS} = 25\text{V}$ , $f = 1\text{MHz}$   |  | 7620 | pF                      |
| $C_{oss}$                           |  |  | 1240 | pF                      |
| $C_{rss}$                           |  |  | 40   | pF                      |
| <b>Effective Output Capacitance</b> |  |  |      |                         |
| $C_{o(er)}$                         | Energy related   | $V_{GS} = 0\text{V}$<br>$V_{DS} = 0.8 \cdot V_{DSS}$ | 730  | pF                      |
| $C_{o(tr)}$                         | Time related   |  | 1700 | pF                      |
| $t_{d(on)}$                         | <b>Resistive Switching Times</b><br>$V_{GS} = 10\text{V}$ , $V_{DS} = 0.5 \cdot V_{DSS}$ , $I_D = 0.5 \cdot I_{D25}$<br>$R_G = 5\Omega$ (External) |  | 30   | ns                      |
| $t_r$                               |  |  | 30   | ns                      |
| $t_{d(off)}$                        |  |  | 90   | ns                      |
| $t_f$                               |  |  | 14   | ns                      |
| $Q_{g(on)}$                         | $V_{GS} = 10\text{V}$ , $V_{DS} = 0.5 \cdot V_{DSS}$ , $I_D = 0.5 \cdot I_{D25}$   |  | 122  | nC                      |
| $Q_{gs}$                            |  |  | 35   | nC                      |
| $Q_{gd}$                            |  |  | 40   | nC                      |
| $R_{thJC}$                          | TO-247& TO-3P  |  |      | 0.24 $^\circ\text{C/W}$ |
| $R_{thCS}$                          |  |  | 0.21 | $^\circ\text{C/W}$      |

#### Source-Drain Diode

| Symbol   | Test Conditions<br>( $T_J = 25^\circ\text{C}$ , Unless Otherwise Specified)    | Characteristic Values |      |       |
|----------|--|-----------------------|------|-------|
|          |  | Min.                  | Typ. | Max   |
| $I_S$    | $V_{GS} = 0\text{V}$   |                       |      | 170 A |
| $I_{SM}$ | Repetitive, pulse Width Limited by $T_{JM}$                                    |                       |      | 680 A |
| $V_{SD}$ | $I_F = 100\text{A}$ , $V_{GS} = 0\text{V}$ , Note 1                            |                       |      | 1.4 V |
| $t_{rr}$ | $I_F = 85\text{A}$ , $-di/dt = 100\text{A}/\mu\text{s}$<br>$V_R = 100\text{V}$ |                       | 90   | ns    |
| $Q_{RM}$ |  |                       | 320  | nC    |
| $I_{RM}$ |  |                       | 7    | A     |

Note 1. Pulse test,  $t \leq 300\mu\text{s}$ , duty cycle,  $d \leq 2\%$ .

#### ADVANCE TECHNICAL INFORMATION

The product presented herein is under development. The Technical Specifications offered are derived from a subjective evaluation of the design, based upon prior knowledge and experience, and constitute a "considered reflection" of the anticipated result. IXYS reserves the right to change limits, test conditions, and dimensions without notice.

IXYS Reserves the Right to Change Limits, Test Conditions, and Dimensions.

|  |           |           |           |           |             |             |             |             |             |             |
|--|-----------|-----------|-----------|-----------|-------------|-------------|-------------|-------------|-------------|-------------|
| IXYS MOSFETs and IGBTs are covered by one or more of the following U.S. patents: | 4,835,592 | 4,931,844 | 5,049,961 | 5,237,481 | 6,162,665   | 6,404,065B1 | 6,683,344   | 6,727,585   | 7,005,734B2 | 7,157,338B2 |
|  | 4,860,072 | 5,017,508 | 5,063,307 | 5,381,025 | 6,259,123B1 | 6,534,343   | 6,710,405B2 | 6,759,692   | 7,063,975B2 |             |
|  | 4,881,106 | 5,034,796 | 5,187,117 | 5,486,715 | 6,306,728B1 | 6,583,505   | 6,710,463   | 6,771,478B2 | 7,071,537   |             |

Fig. 1. Output Characteristics @  $T_J = 25^\circ\text{C}$

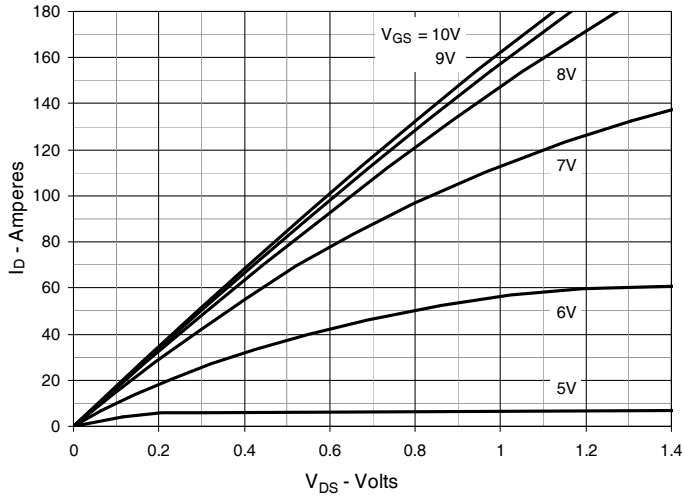

Fig. 2. Extended Output Characteristics @  $T_J = 25^\circ\text{C}$

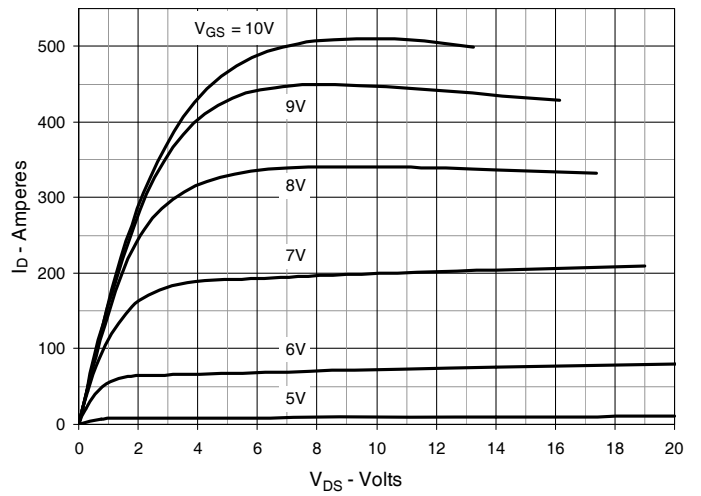

Fig. 3. Output Characteristics @  $T_J = 125^\circ\text{C}$

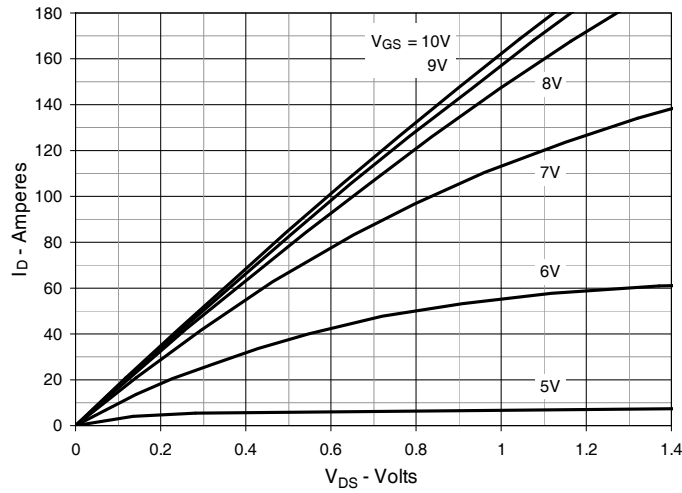

Fig. 4.  $R_{DS(on)}$  Normalized to  $I_D = 85\text{A}$  Value vs. Junction Temperature

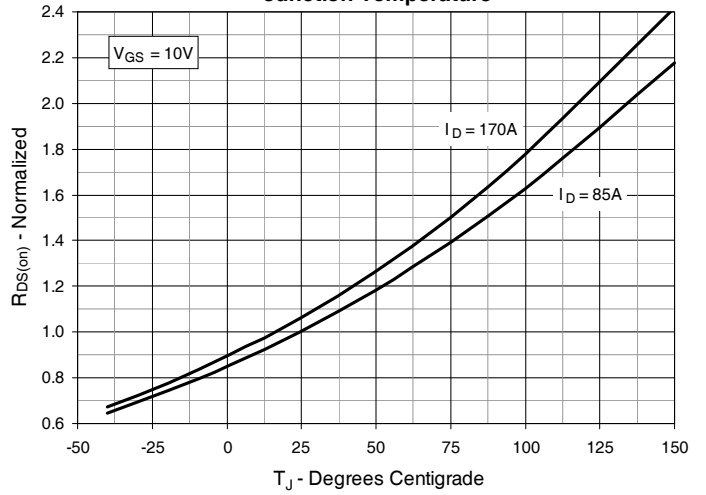

Fig. 5.  $R_{DS(on)}$  Normalized to  $I_D = 85\text{A}$  Value vs. Drain Current

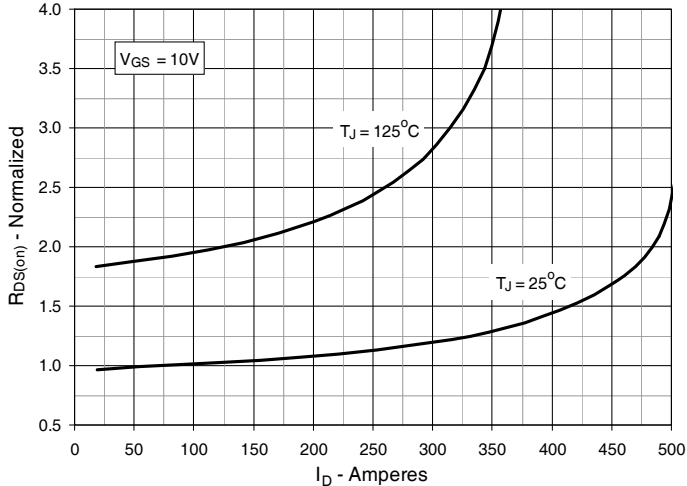
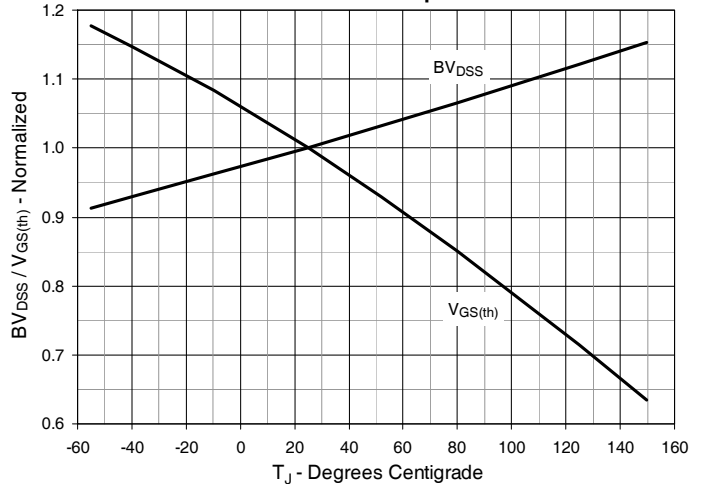
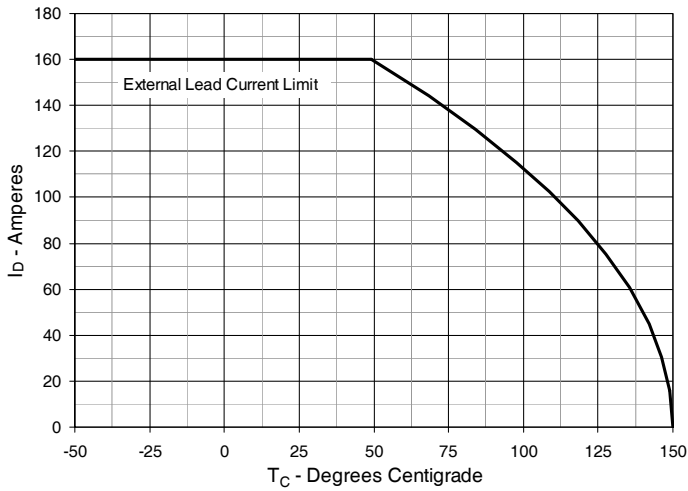

Fig. 6. Normalized Breakdown & Threshold Voltages vs. Junction Temperature



**Fig. 7. Maximum Drain Current vs. Case Temperature**



**Fig. 8. Input Admittance**

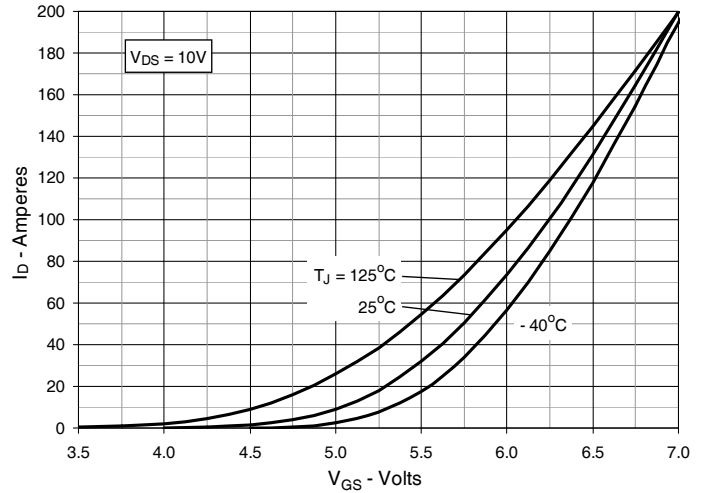

**Fig. 9. Transconductance**

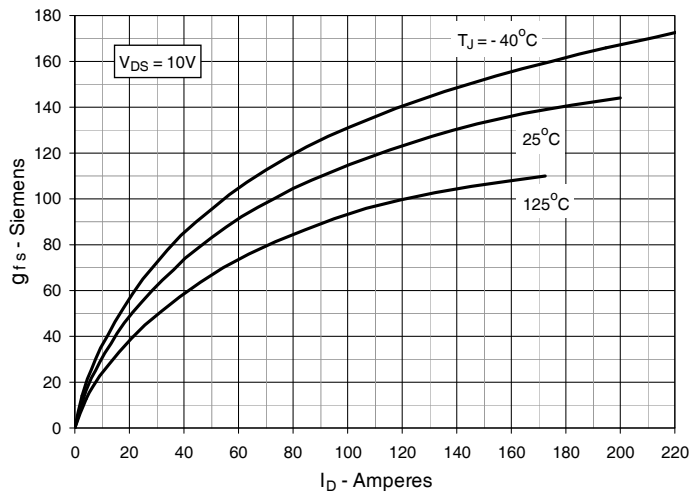

**Fig. 10. Forward Voltage Drop of Intrinsic Diode**

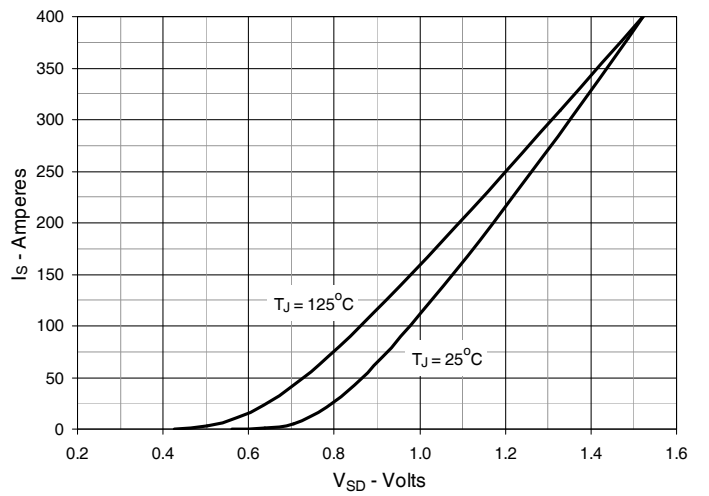

**Fig. 11. Gate Charge**

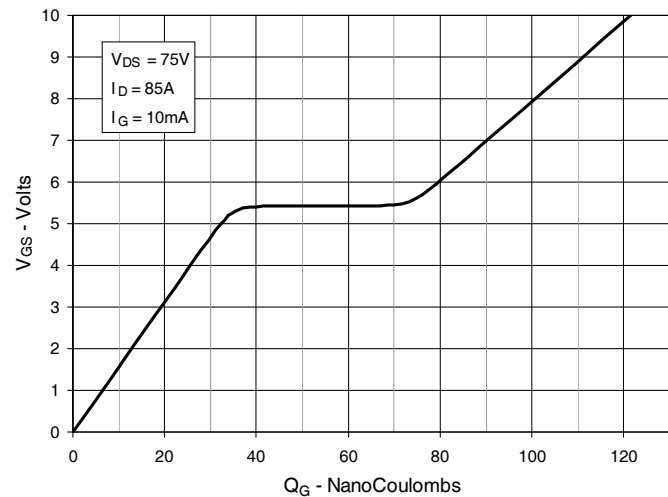

**Fig. 12. Capacitance**

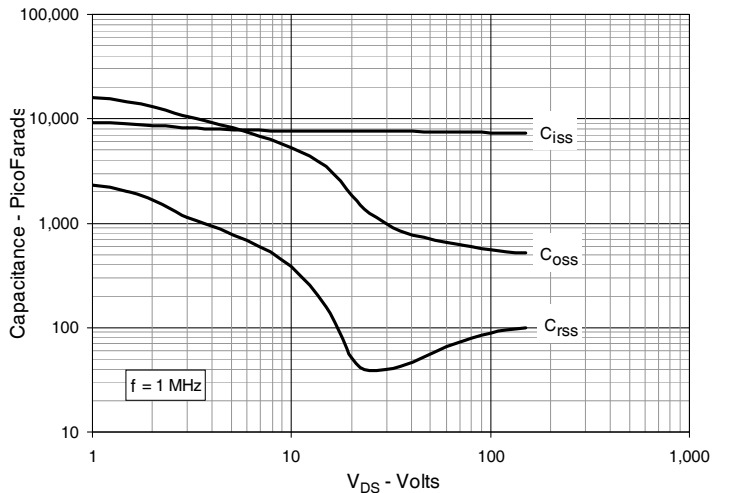

Fig. 13. Output Capacitance Stored Energy

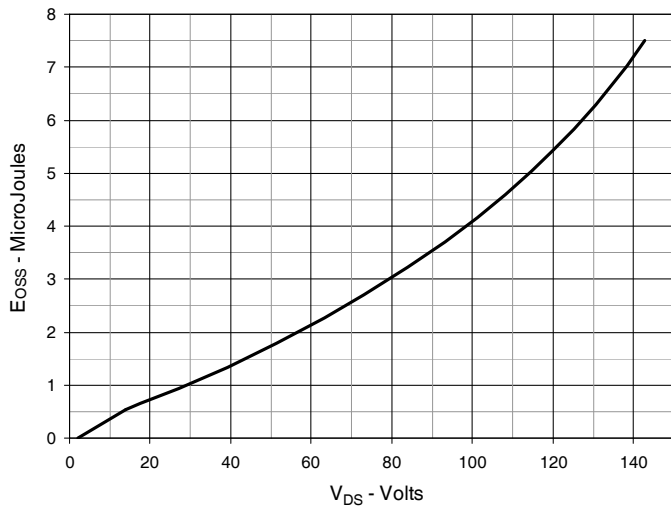

Fig. 14. Forward-Bias Safe Operating Area

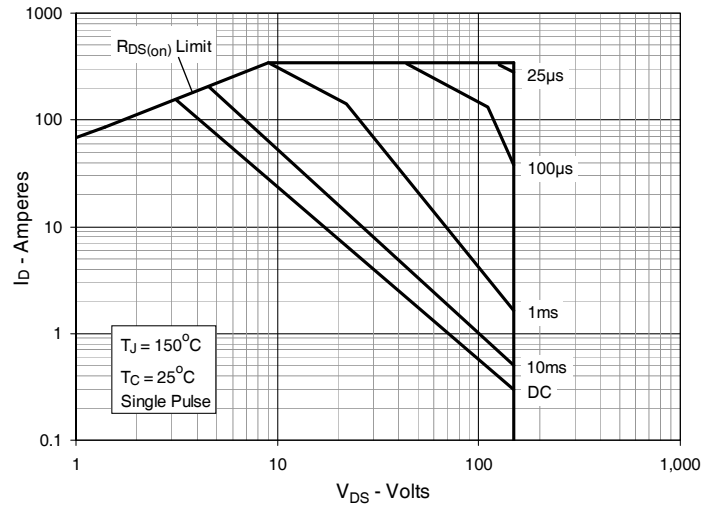
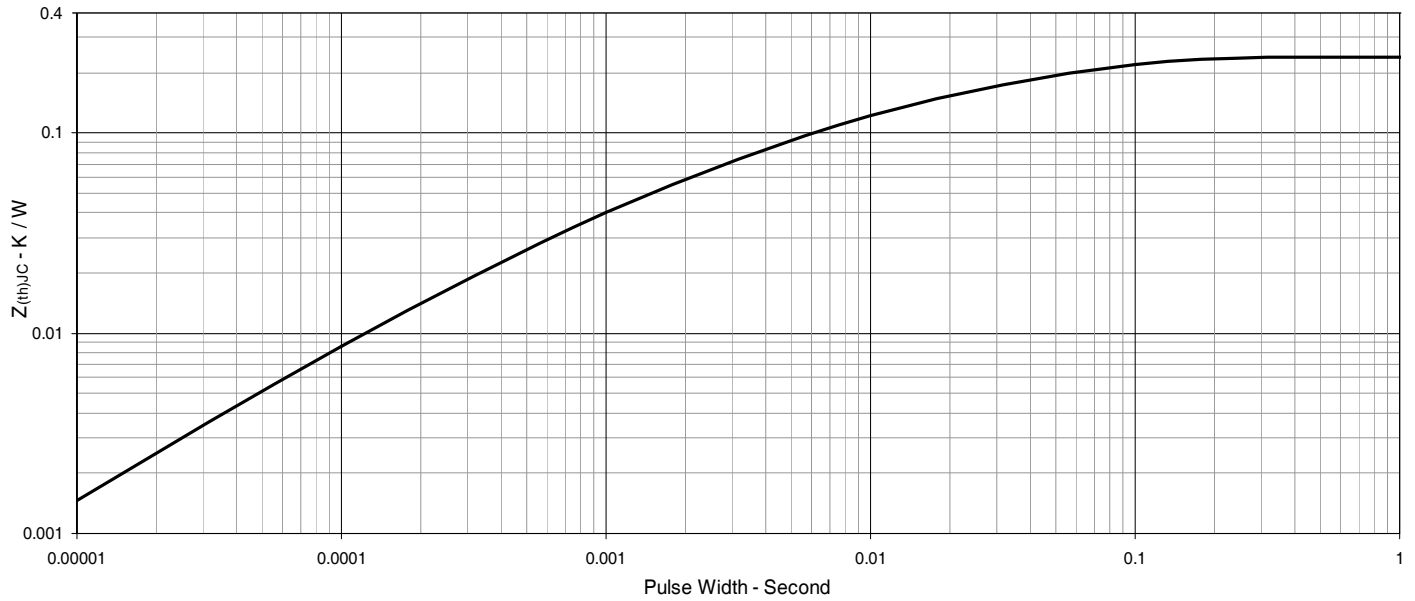
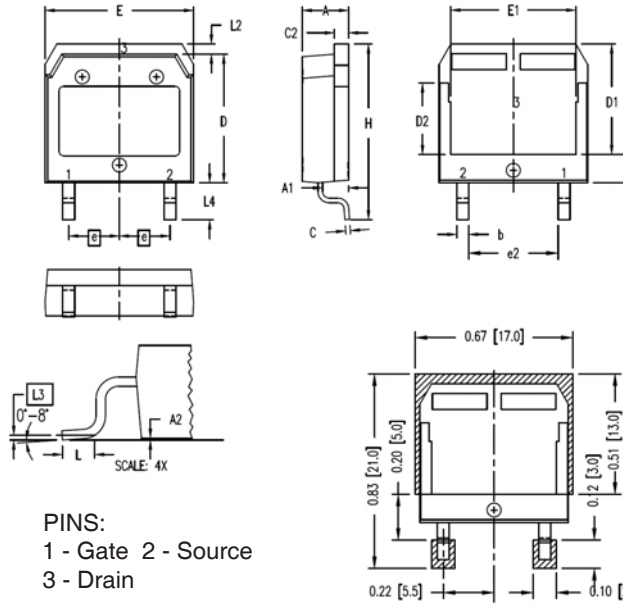

Fig. 15. Maximum Transient Thermal Impedance



### TO-268HV Outline



| SYM  | INCHES   |      | MILLIMETER |       |
|------|----------|------|------------|-------|
|      | MIN      | MAX  | MIN        | MAX   |
| A    | .193     | .201 | 4.90       | 5.10  |
| A1   | .106     | .114 | 2.70       | 2.90  |
| A2   | .001     | .010 | 0.02       | 0.25  |
| b    | .045     | .057 | 1.15       | 1.45  |
| C    | .016     | .026 | 0.40       | 0.65  |
| C2   | .057     | .063 | 1.45       | 1.60  |
| D    | .543     | .551 | 13.80      | 14.00 |
| D1   | .465     | .476 | 11.80      | 12.10 |
| D2   | .295     | .307 | 7.50       | 7.80  |
| D3   | .114     | .126 | 2.90       | 3.20  |
| E    | .624     | .632 | 15.85      | 16.05 |
| E1   | .524     | .535 | 13.30      | 13.60 |
| e    | .215 BSC |      | 5.45 BSC   |       |
| (e2) | .374     | .386 | 9.50       | 9.80  |
| H    | .736     | .752 | 18.70      | 19.10 |
| L    | .067     | .079 | 1.70       | 2.00  |
| L2   | .039     | .045 | 1.00       | 1.15  |
| L3   | .010 BSC |      | 0.25 BSC   |       |
| L4   | .150     | .161 | 3.80       | 4.10  |

### TO-247 Outline

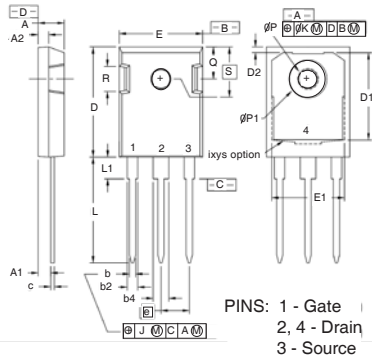

| SYM | INCHES   |      | MILLIMETERS |       |
|-----|----------|------|-------------|-------|
|     | MIN      | MAX  | MIN         | MAX   |
| A   | .190     | .205 | 4.83        | 5.21  |
| A1  | .090     | .100 | 2.29        | 2.54  |
| A2  | .075     | .085 | 1.91        | 2.16  |
| b   | .045     | .055 | 1.14        | 1.40  |
| b2  | .075     | .087 | 1.91        | 2.20  |
| b4  | .115     | .126 | 2.92        | 3.20  |
| C   | .024     | .031 | 0.61        | 0.80  |
| D   | .819     | .840 | 20.80       | 21.34 |
| D1  | .650     | .690 | 16.51       | 17.53 |
| D2  | .035     | .050 | 0.89        | 1.27  |
| E   | .620     | .635 | 15.75       | 16.13 |
| E1  | .545     | .565 | 13.84       | 14.35 |
| e   | .215 BSC |      | 5.45 BSC    |       |
| J   | ---      | .010 | ---         | 0.25  |
| K   | ---      | .025 | ---         | 0.64  |
| L   | .780     | .810 | 19.81       | 20.57 |
| L1  | .150     | .170 | 3.81        | 4.32  |
| L2  | .140     | .144 | 3.55        | 3.65  |
| øP  | .140     | .144 | 3.55        | 3.65  |
| øP1 | .275     | .290 | 6.99        | 7.37  |
| Q   | .220     | .244 | 5.59        | 6.20  |
| R   | .170     | .190 | 4.32        | 4.83  |
| S   | .242 BSC |      | 6.15 BSC    |       |

### TO-3P Outline

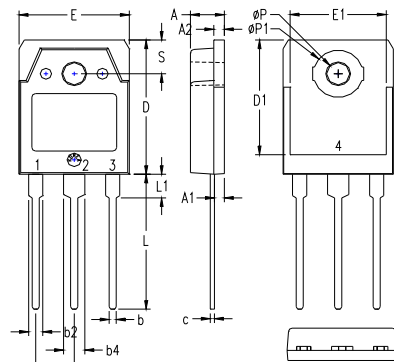

| SYM | INCHES   |      | MILLIMETERS |       |
|-----|----------|------|-------------|-------|
|     | MIN      | MAX  | MIN         | MAX   |
| A   | .185     | .193 | 4.70        | 4.90  |
| A1  | .051     | .059 | 1.30        | 1.50  |
| A2  | .057     | .065 | 1.45        | 1.65  |
| b   | .035     | .045 | 0.90        | 1.15  |
| b2  | .075     | .087 | 1.90        | 2.20  |
| b4  | .114     | .126 | 2.90        | 3.20  |
| c   | .022     | .031 | 0.55        | 0.80  |
| D   | .780     | .791 | 19.80       | 20.10 |
| D1  | .665     | .677 | 16.90       | 17.20 |
| E   | .610     | .622 | 15.50       | 15.80 |
| E1  | .531     | .539 | 13.50       | 13.70 |
| e   | .215 BSC |      | 5.45 BSC    |       |
| L   | .779     | .795 | 19.80       | 20.20 |
| L1  | .134     | .142 | 3.40        | 3.60  |
| øP  | .126     | .134 | 3.20        | 3.40  |
| øP1 | .272     | .280 | 6.90        | 7.10  |
| S   | .193     | .201 | 4.90        | 5.10  |

All metal area are tin plated.



---

Disclaimer Notice - Information furnished is believed to be accurate and reliable. However, users should independently evaluate the suitability of and test each product selected for their own applications. Littelfuse products are not designed for, and may not be used in, all applications. Read complete Disclaimer Notice at [www.littelfuse.com/disclaimer-electronics](http://www.littelfuse.com/disclaimer-electronics).