

# X3-Class HiPerFET™ Power MOSFET

**IXFA56N30X3**  
**IXFP56N30X3**  
**IXFH56N30X3**

$V_{DSS} = 300V$   
 $I_{D25} = 56A$   
 $R_{DS(on)} \leq 27m\Omega$

N-Channel Enhancement Mode  
Avalanche Rated

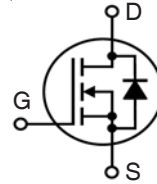

Symbol	Test Conditions	Maximum Ratings	
$V_{DSS}$	$T_J = 25^\circ C$ to $150^\circ C$	300	V
$V_{DGR}$	$T_J = 25^\circ C$ to $150^\circ C$ , $R_{GS} = 1M\Omega$	300	V
$V_{GSS}$	Continuous	$\pm 20$	V
$V_{GSM}$	Transient	$\pm 30$	V
$I_{D25}$	$T_C = 25^\circ C$	56	A
$I_{DM}$	$T_C = 25^\circ C$ , Pulse Width Limited by $T_{JM}$	112	A
$I_A$	$T_C = 25^\circ C$	28	A
$E_{AS}$	$T_C = 25^\circ C$	700	mJ
$dv/dt$	$I_S \leq I_{DM}$ , $V_{DD} \leq V_{DSS}$ , $T_J \leq 150^\circ C$	50	V/ns
$P_D$	$T_C = 25^\circ C$	320	W
$T_J$		-55 ... +150	$^\circ C$
$T_{JM}$		150	$^\circ C$
$T_{stg}$		-55 ... +150	$^\circ C$
$T_L$	Maximum Lead Temperature for Soldering	300	$^\circ C$
$T_{SOLD}$	1.6 mm (0.062in.) from Case for 10s	260	$^\circ C$
$F_C$	Mounting Force (TO-263)	10..65 / 2.2..14.6	N/lb
$M_d$	Mounting Torque (TO-220 & TO-247)	1.13 / 10	Nm/lb.in
<b>Weight</b>	TO-263	2.5	g
	TO-220	3.0	g
	TO-247	6.0	g

Symbol	Test Conditions ( $T_J = 25^\circ C$ , Unless Otherwise Specified)	Characteristic Values		
		Min.	Typ.	Max.
$BV_{DSS}$	$V_{GS} = 0V$ , $I_D = 1mA$	300		V
$V_{GS(th)}$	$V_{DS} = V_{GS}$ , $I_D = 1.5mA$	2.5		4.5 V
$I_{GSS}$	$V_{GS} = \pm 20V$ , $V_{DS} = 0V$			$\pm 100$ nA
$I_{DSS}$	$V_{DS} = V_{DSS}$ , $V_{GS} = 0V$ $T_J = 125^\circ C$			5 $\mu A$ 500 $\mu A$
$R_{DS(on)}$	$V_{GS} = 10V$ , $I_D = 0.5 \cdot I_{D25}$ , Note 1		21	27 $m\Omega$

TO-263  
(IXFA)

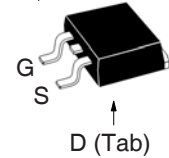

TO-220  
(IXFP)

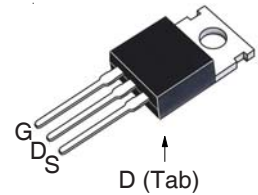

TO-247  
(IXFH)

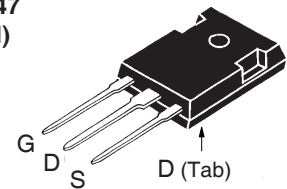

G = Gate      D = Drain  
S = Source    Tab = Drain

## Features

- International Standard Packages
- Low  $R_{DS(ON)}$  and  $Q_G$
- Avalanche Rated
- Low Package Inductance

## Advantages

- High Power Density
- Easy to Mount
- Space Savings

## Applications

- Switch-Mode and Resonant-Mode Power Supplies
- DC-DC Converters
- PFC Circuits
- AC and DC Motor Drives
- Robotics and Servo Controls

Symbol	Test Conditions ( $T_J = 25^\circ\text{C}$ , Unless Otherwise Specified)	Characteristic Values		
		Min.	Typ.	Max
$g_{fs}$	$V_{DS} = 10\text{V}$ , $I_D = 0.5 \cdot I_{D25}$ , Note 1	26	43	S
$R_{Gi}$	Gate Input Resistance		2.3	$\Omega$
$C_{iss}$	} $V_{GS} = 0\text{V}$ , $V_{DS} = 25\text{V}$ , $f = 1\text{MHz}$		3750	pF
$C_{oss}$			560	pF
$C_{rss}$			3	pF
<b>Effective Output Capacitance</b>				
$C_{o(er)}$	Energy related } $V_{GS} = 0\text{V}$		210	pF
$C_{o(tr)}$	Time related } $V_{DS} = 0.8 \cdot V_{DSS}$		860	pF
$t_{d(on)}$	} <b>Resistive Switching Times</b> $V_{GS} = 10\text{V}$ , $V_{DS} = 0.5 \cdot V_{DSS}$ , $I_D = 0.5 \cdot I_{D25}$ $R_G = 5\Omega$ (External)		21	ns
$t_r$			26	ns
$t_{d(off)}$			64	ns
$t_f$			10	ns
$Q_{g(on)}$	} $V_{GS} = 10\text{V}$ , $V_{DS} = 0.5 \cdot V_{DSS}$ , $I_D = 0.5 \cdot I_{D25}$		56	nC
$Q_{gs}$			18	nC
$Q_{gd}$			17	nC
$R_{thJC}$	TO-220 TO-247			0.39 $^\circ\text{C/W}$
$R_{thCS}$			0.50 0.21	$^\circ\text{C/W}$ $^\circ\text{C/W}$

**Source-Drain Diode**

Symbol	Test Conditions ( $T_J = 25^\circ\text{C}$ , Unless Otherwise Specified)	Characteristic Values		
		Min.	Typ.	Max
$I_S$	$V_{GS} = 0\text{V}$			56 A
$I_{SM}$	Repetitive, Pulse Width Limited by $T_{JM}$			224 A
$V_{SD}$	$I_F = I_S$ , $V_{GS} = 0\text{V}$ , Note 1			1.4 V
$t_{rr}$	} $I_F = 28\text{A}$ , $-di/dt = 100\text{A}/\mu\text{s}$ $V_R = 100\text{V}$		115	ns
$Q_{RM}$			580	nC
$I_{RM}$			10	A

Note 1. Pulse test,  $t \leq 300\mu\text{s}$ , duty cycle,  $d \leq 2\%$ .

IXYS Reserves the Right to Change Limits, Test Conditions, and Dimensions.

IXYS MOSFETs and IGBTs are covered by one or more of the following U.S. patents:	4,835,592	4,931,844	5,049,961	5,237,481	6,162,665	6,404,065B1	6,683,344	6,727,585	7,005,734B2	7,157,338B2
	4,860,072	5,017,508	5,063,307	5,381,025	6,259,123B1	6,534,343	6,710,405B2	6,759,692	7,063,975B2	
	4,881,106	5,034,796	5,187,117	5,486,715	6,306,728B1	6,583,505	6,710,463	6,771,478B2	7,071,537	

Fig. 1. Output Characteristics @  $T_J = 25^\circ\text{C}$

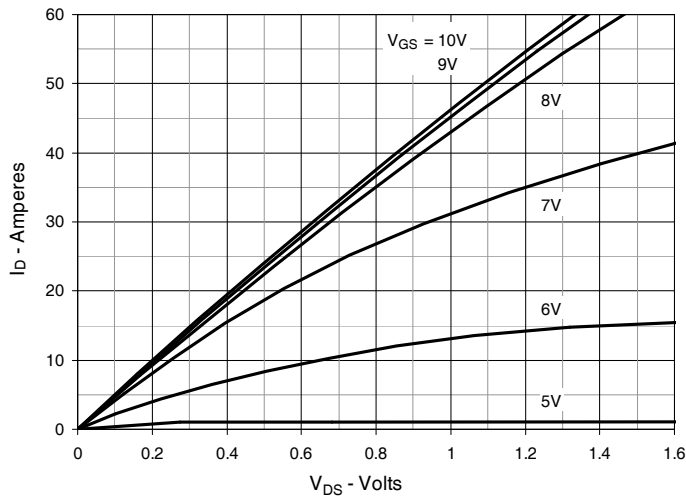

Fig. 2. Extended Output Characteristics @  $T_J = 25^\circ\text{C}$

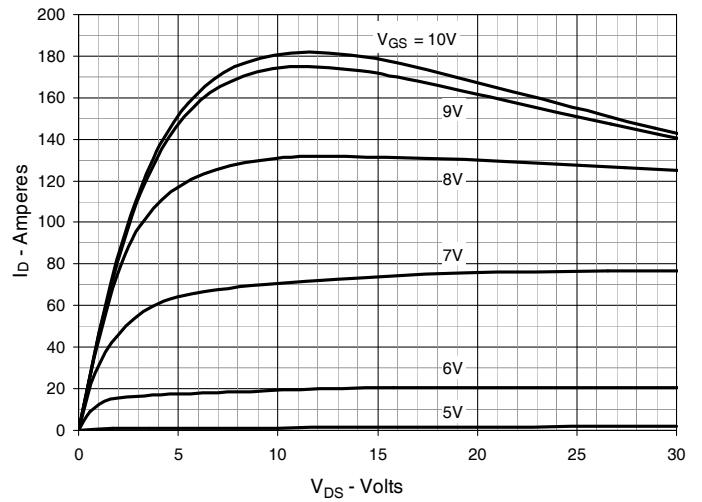

Fig. 3. Output Characteristics @  $T_J = 125^\circ\text{C}$

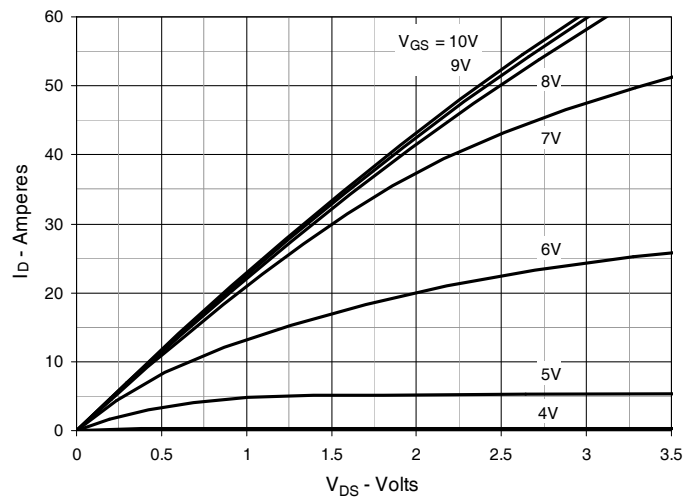

Fig. 4.  $R_{DS(on)}$  Normalized to  $I_D = 28\text{A}$  Value vs. Junction Temperature

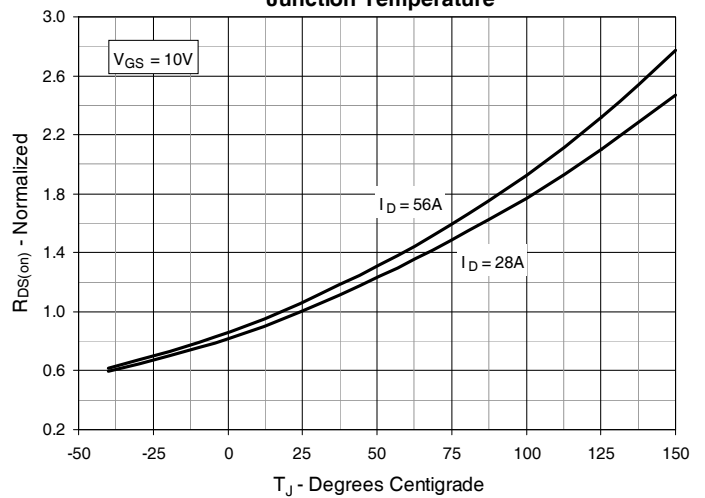

Fig. 5.  $R_{DS(on)}$  Normalized to  $I_D = 28\text{A}$  Value vs. Drain Current

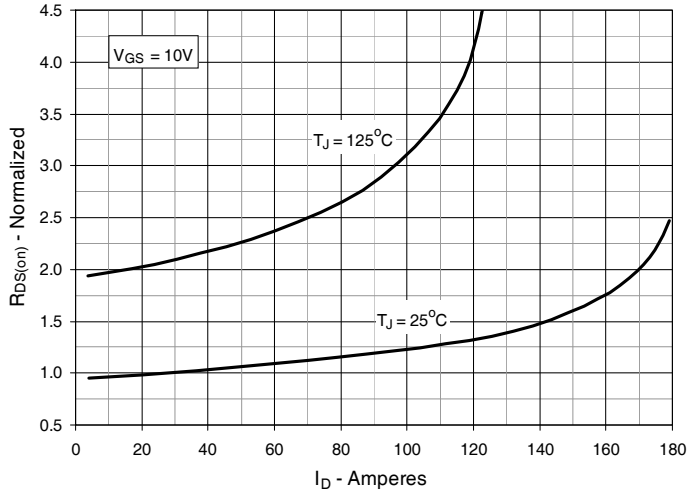

Fig. 6. Normalized Breakdown & Threshold Voltages vs. Junction Temperature

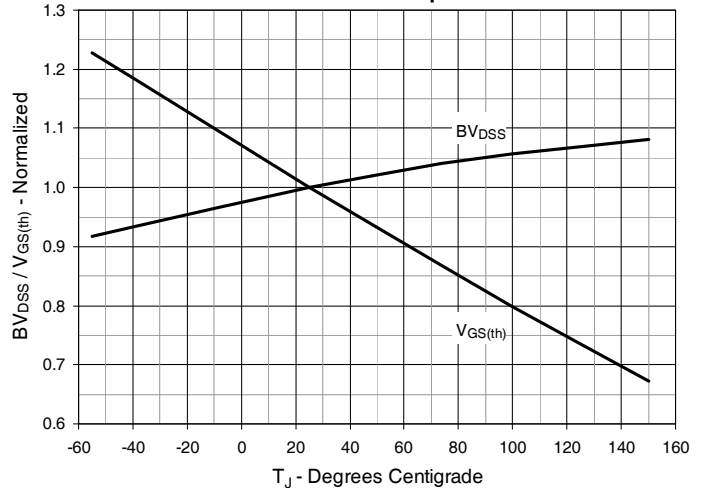

Fig. 7. Maximum Drain Current vs. Case Temperature

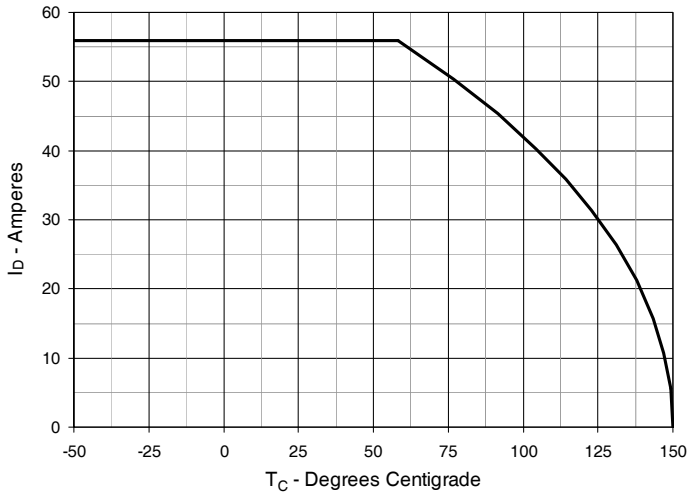

Fig. 8. Input Admittance

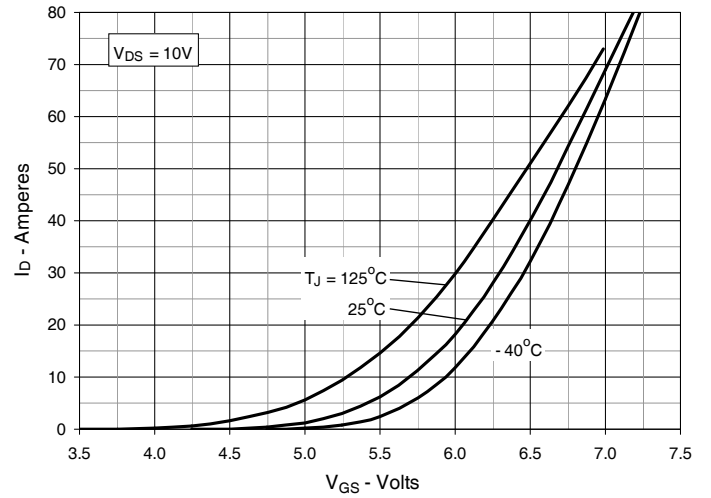

Fig. 9. Transconductance

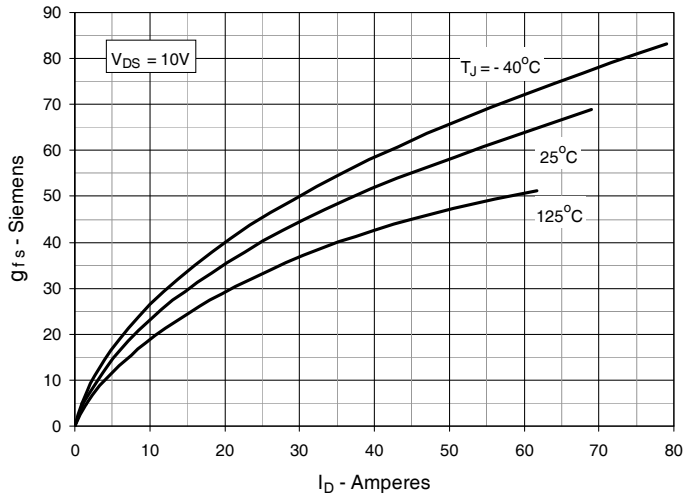

Fig. 10. Forward Voltage Drop of Intrinsic Diode

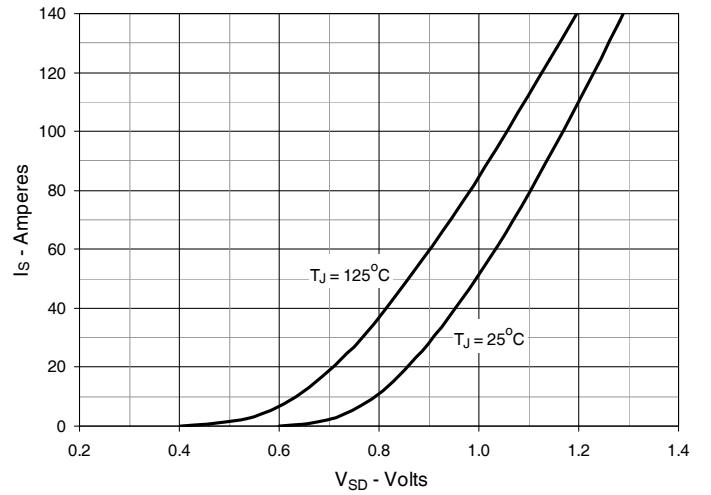

Fig. 11. Gate Charge

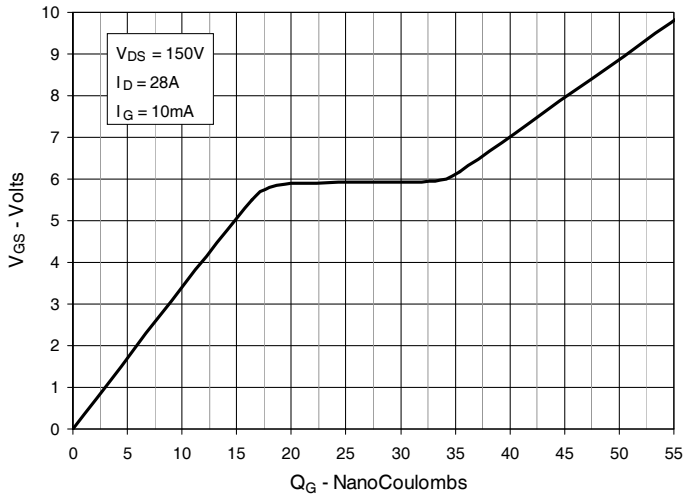

Fig. 12. Capacitance

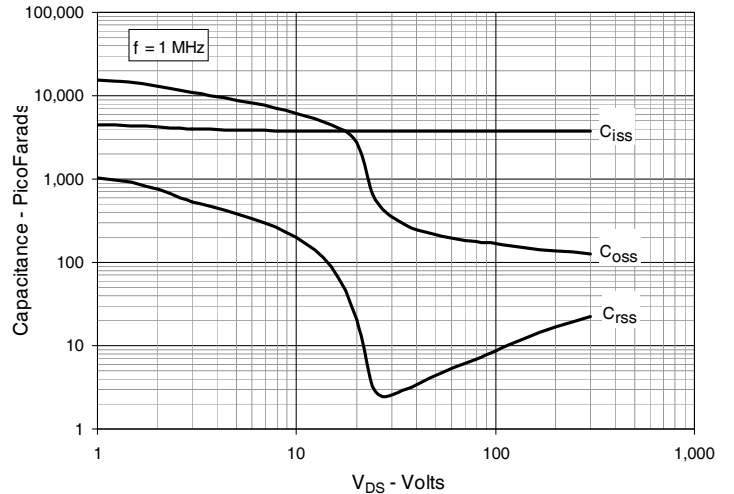

Fig. 13. Output Capacitance Stored Energy

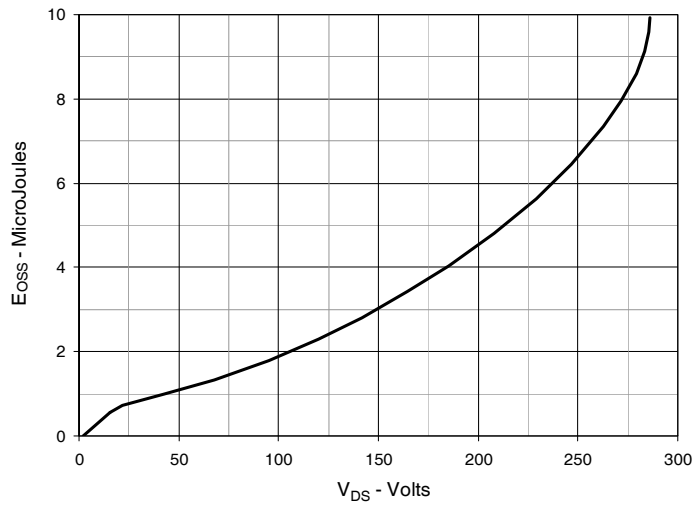

Fig. 14. Forward-Bias Safe Operating Area

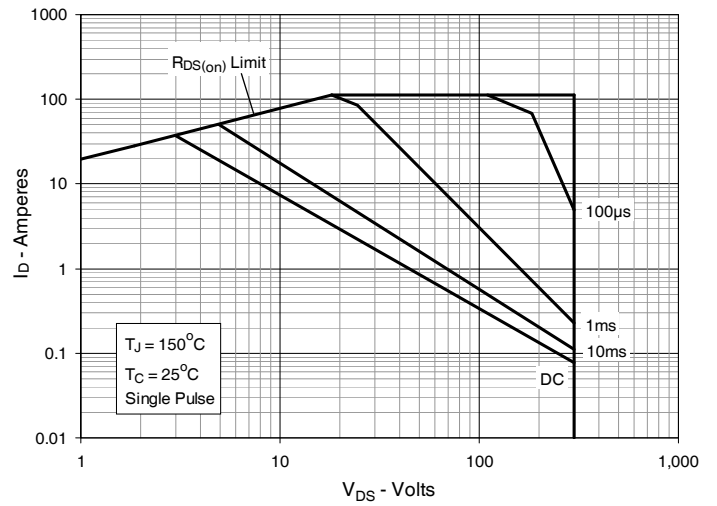
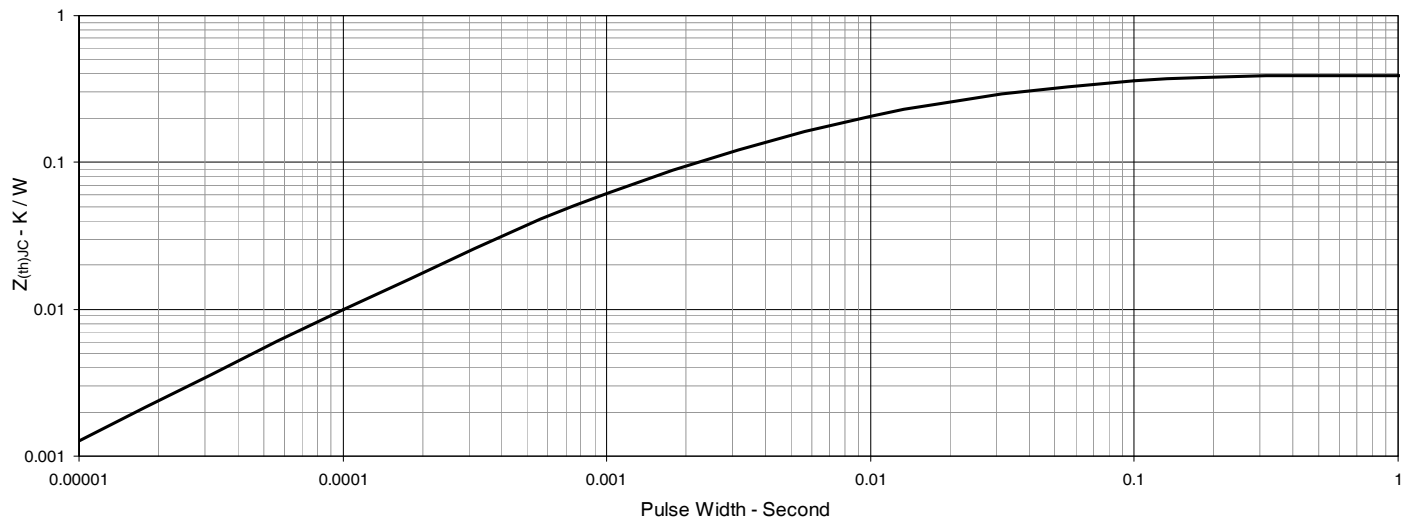
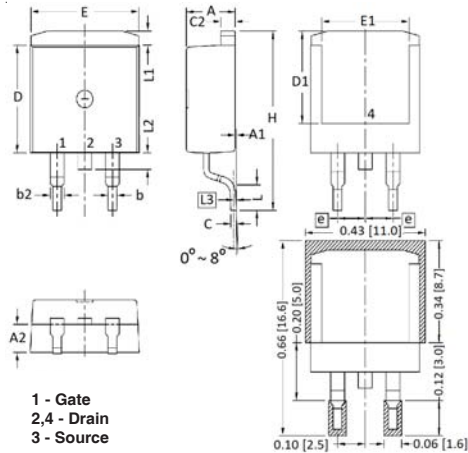

Fig. 15. Maximum Transient Thermal Impedance



**TO-263 Outline**



SYM	INCHES		MILLIMETER	
	MIN	MAX	MIN	MAX
A	.170	.185	4.30	4.70
A1	.000	.008	0.00	0.20
A2	.091	.098	2.30	2.50
b	.028	.035	0.70	0.90
b2	.046	.060	1.18	1.52
C	.018	.024	0.45	0.60
C2	.049	.060	1.25	1.52
D	.340	.370	8.63	9.40
D1	.300	.327	7.62	8.30
E	.380	.410	9.65	10.41
E1	.270	.330	6.86	8.38
e	.100 BSC		2.54 BSC	
H	.580	.620	14.73	15.75
L	.075	.105	1.91	2.67
L1	.039	.060	1.00	1.52
L2	—	.070	—	1.77
L3	.010 BSC		0.254 BSC	

**TO-220 Outline**

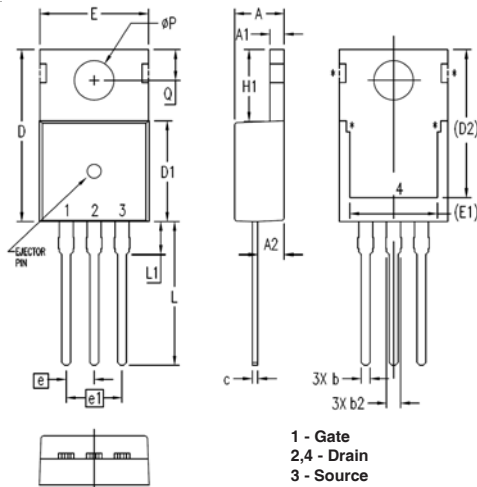

SYM	INCHES		MILLIMETERS	
	MIN	MAX	MIN	MAX
A	.169	.185	4.30	4.70
A1	.047	.055	1.20	1.40
A2	.079	.106	2.00	2.70
b	.024	.039	0.60	1.00
b2	.045	.057	1.15	1.45
c	.014	.026	0.35	0.65
D	.587	.626	14.90	15.90
D1	.335	.370	8.50	9.40
(D2)	.500	.531	12.70	13.50
E	.382	.406	9.70	10.30
(E1)	.283	.323	7.20	8.20
e	.100 BSC		2.54 BSC	
e1	.200 BSC		5.08 BSC	
H1	.244	.268	6.20	6.80
L	.492	.547	12.50	13.90
L1	.110	.154	2.80	3.90
ØP	.134	.150	3.40	3.80
Q	.106	.126	2.70	3.20

**TO-247 Outline**

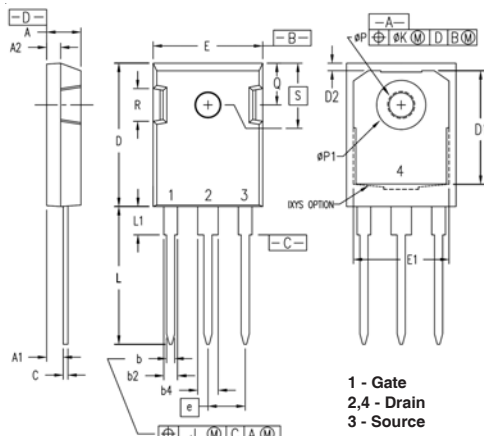

SYM	INCHES		MILLIMETERS	
	MIN	MAX	MIN	MAX
A	.190	.205	4.83	5.21
A1	.090	.100	2.29	2.54
A2	.075	.085	1.91	2.16
b	.045	.055	1.14	1.40
b2	.075	.087	1.91	2.20
b4	.115	.126	2.92	3.20
C	.024	.031	0.61	0.80
D	.819	.840	20.80	21.34
D1	.650	.690	16.51	17.53
D2	.035	.050	0.89	1.27
E	.620	.635	15.75	16.13
E1	.545	.565	13.84	14.35
e	.215 BSC		5.45 BSC	
J	--	.010	--	0.25
K	--	.025	--	0.64
L	.780	.810	19.81	20.57
L1	.150	.170	3.81	4.32
ØP	.140	.144	3.55	3.65
ØP1	.275	.290	6.99	7.37
Q	.220	.244	5.59	6.20
R	.170	.190	4.32	4.83
S	.242 BSC		6.15 BSC	



---

Disclaimer Notice - Information furnished is believed to be accurate and reliable. However, users should independently evaluate the suitability of and test each product selected for their own applications. Littelfuse products are not designed for, and may not be used in, all applications. Read complete Disclaimer Notice at [www.littelfuse.com/disclaimer-electronics](http://www.littelfuse.com/disclaimer-electronics).

---