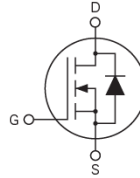


# X3-Class HiPerFET™ Power MOSFET

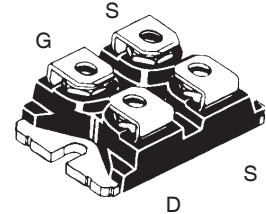
## IXFN240N25X3

$V_{DSS} = 250V$   
 $I_{D25} = 240A$   
 $R_{DS(on)} \leq 4.5m\Omega$

N-Channel Enhancement Mode  
 Avalanche Rated  
 Fast Intrinsic Diode



miniBLOC, SOT-227  
 E153432



G = Gate      D = Drain  
 S = Source

Symbol	Test Conditions	Maximum Ratings	
$V_{DSS}$	$T_J = 25^\circ C$ to $150^\circ C$	250	V
$V_{DGR}$	$T_J = 25^\circ C$ to $150^\circ C$ , $R_{GS} = 1M\Omega$	250	V
$V_{GSS}$	Continuous	$\pm 20$	V
$V_{GSM}$	Transient	$\pm 30$	V
$I_{D25}$	$T_C = 25^\circ C$ (Chip Capability)	240	A
$I_{L(RMS)}$	External Lead Current Limit	200	A
$I_{DM}$	$T_C = 25^\circ C$ , Pulse Width Limited by $T_{JM}$	600	A
$I_A$	$T_C = 25^\circ C$	200	A
$E_{AS}$	$T_C = 25^\circ C$	3	J
$P_D$	$T_C = 25^\circ C$	695	W
dv/dt	$I_S \leq I_{DM}$ , $V_{DD} \leq V_{DSS}$ , $T_J \leq 150^\circ C$	50	V/ns
$T_J$		-55 ... +150	$^\circ C$
$T_{JM}$		150	$^\circ C$
$T_{stg}$		-55 ... +150	$^\circ C$
$V_{ISOL}$	50/60 Hz, RMS $t = 1$ minute	2500	V~
	$I_{ISOL} \leq 1mA$ $t = 1$ second	3000	V~
$M_d$	Mounting Torque	1.5/13	Nm/lb.in
	Terminal Connection Torque	1.3/11.5	Nm/lb.in
Weight		30	g

### Features

- International Standard Package
- miniBLOC, with Aluminium Nitride Isolation
- Isolation Voltage 2500V~
- High Current Handling Capability
- Fast Intrinsic Diode
- Avalanche Rated
- Low  $R_{DS(on)}$

### Advantages

- High Power Density
- Easy to Mount
- Space Savings

### Applications

- Switch-Mode and Resonant-Mode Power Supplies
- DC-DC Converters
- PFC Circuits
- AC and DC Motor Drives
- Robotics and Servo Controls

Symbol	Test Conditions ( $T_J = 25^\circ C$ Unless Otherwise Specified)	Characteristic Values		
		Min.	Typ.	Max.
$BV_{DSS}$	$V_{GS} = 0V$ , $I_D = 3mA$	250		V
$V_{GS(th)}$	$V_{DS} = V_{GS}$ , $I_D = 8mA$	2.5		V
$I_{GSS}$	$V_{GS} = \pm 20V$ , $V_{DS} = 0V$			$\pm 200$ nA
$I_{DSS}$	$V_{DS} = V_{DSS}$ , $V_{GS} = 0V$ $T_J = 125^\circ C$			25 $\mu A$
				2.5 mA
$R_{DS(on)}$	$V_{GS} = 10V$ , $I_D = 120A$ , Note 1	3.5	4.5	$m\Omega$

Symbol	Test Conditions ( $T_J = 25^\circ\text{C}$ , Unless Otherwise Specified)	Characteristic Values		
		Min.	Typ.	Max
$g_{fs}$	$V_{DS} = 10\text{V}$ , $I_D = 60\text{A}$ , Note 1	80	135	S
$R_{Gi}$	Gate Input Resistance		1.8	$\Omega$
$C_{iss}$	$V_{GS} = 0\text{V}$ , $V_{DS} = 25\text{V}$ , $f = 1\text{MHz}$		23.8	nF
$C_{oss}$			3.7	nF
$C_{rss}$			1.5	pF
<b>Effective Output Capacitance</b>				
$C_{o(er)}$	Energy related	$V_{GS} = 0\text{V}$ $V_{DS} = 0.8 \cdot V_{DSS}$	1400	pF
$C_{o(tr)}$	Time related		5480	pF
<b>Resistive Switching Times</b>				
$t_{d(on)}$	$V_{GS} = 10\text{V}$ , $V_{DS} = 0.5 \cdot V_{DSS}$ , $I_D = 120\text{A}$ $R_G = 1\Omega$ (External)		36	ns
$t_r$			32	ns
$t_{d(off)}$			180	ns
$t_f$			14	ns
$Q_{g(on)}$	$V_{GS} = 10\text{V}$ , $V_{DS} = 0.5 \cdot V_{DSS}$ , $I_D = 120\text{A}$		345	nC
$Q_{gs}$			112	nC
$Q_{gd}$			72	nC
$R_{thJC}$				0.18 $^\circ\text{C/W}$
$R_{thCS}$		0.05		$^\circ\text{C/W}$

**Source-Drain Diode**

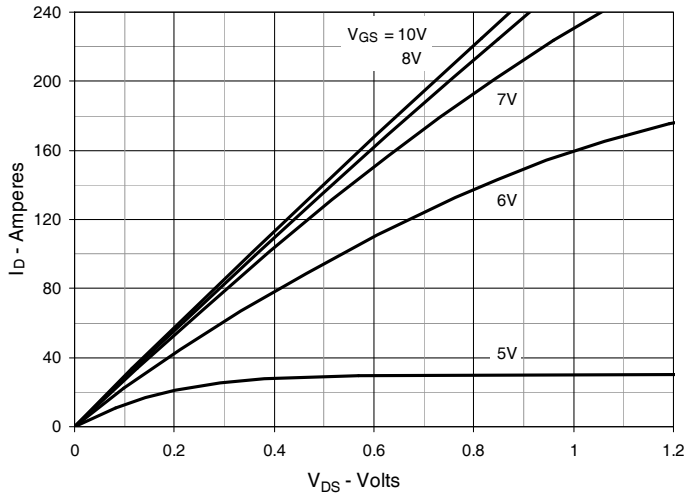
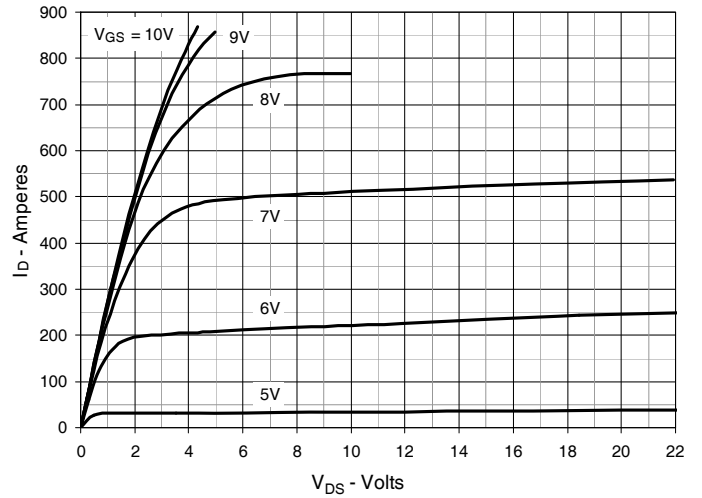
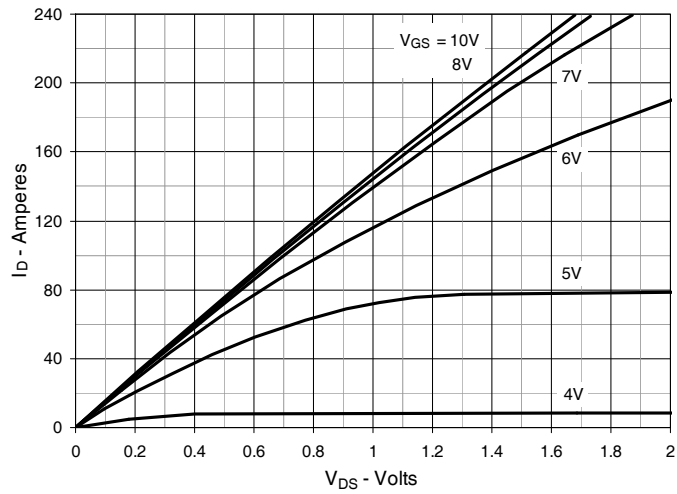
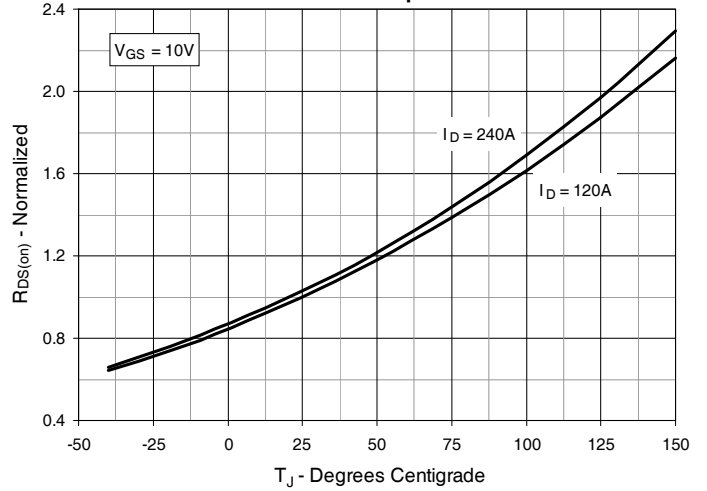
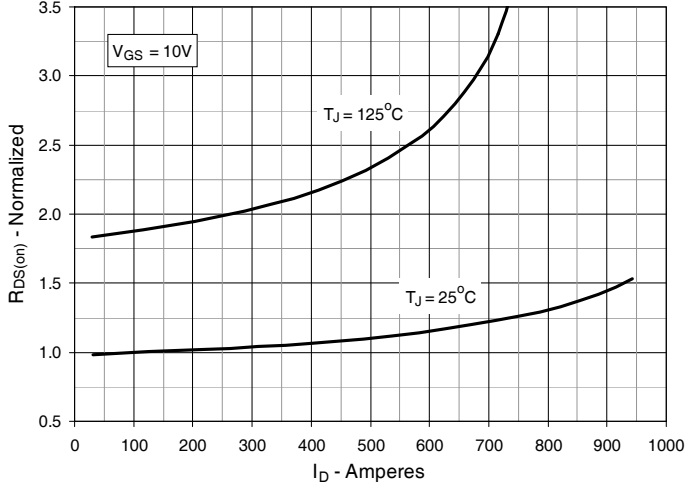
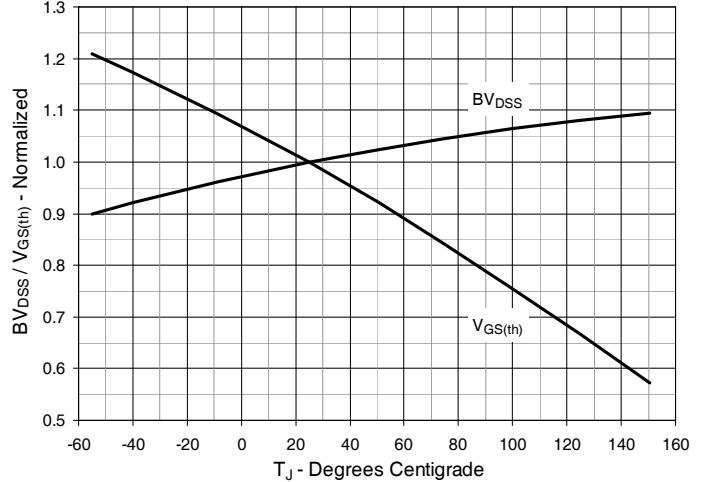
Symbol	Test Conditions ( $T_J = 25^\circ\text{C}$ , Unless Otherwise Specified)	Characteristic Values		
		Min.	Typ.	Max
$I_S$	$V_{GS} = 0\text{V}$			240 A
$I_{SM}$	Repetitive, Pulse Width Limited by $T_{JM}$			960 A
$V_{SD}$	$I_F = 100\text{A}$ , $V_{GS} = 0\text{V}$ , Note 1			1.4 V
$t_{rr}$	$I_F = 120\text{A}$ , $-di/dt = 100\text{A}/\mu\text{s}$ $V_R = 100\text{V}$		165	ns
$Q_{RM}$			3.7	$\mu\text{C}$
$I_{RM}$			45.6	A

Note 1. Pulse test,  $t \leq 300\mu\text{s}$ , duty cycle,  $d \leq 2\%$ .

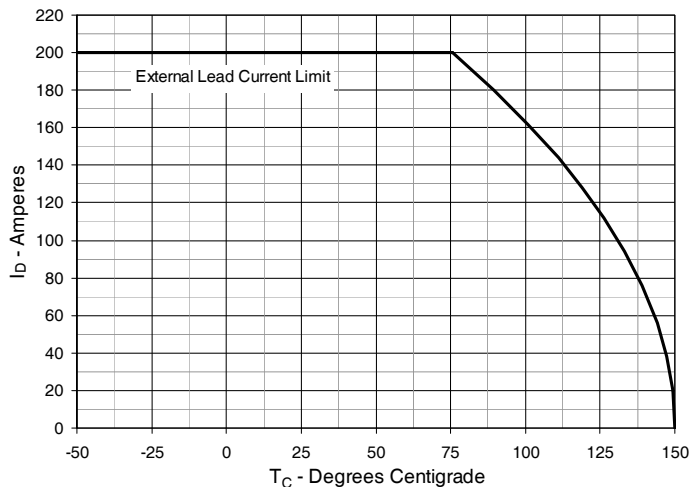
IXYS Reserves the Right to Change Limits, Test Conditions, and Dimensions.

IXYS MOSFETs and IGBTs are covered by one or more of the following U.S. patents:

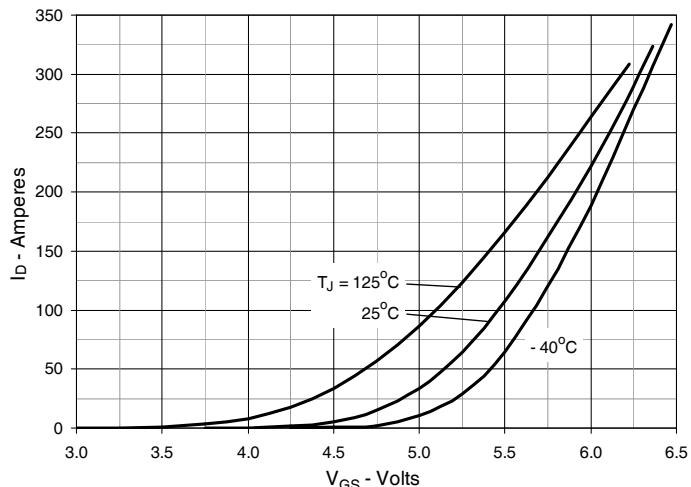
4,835,592	4,931,844	5,049,961	5,237,481	6,162,665	6,404,065 B1	6,683,344	6,727,585	7,005,734 B2	7,157,338B2
4,860,072	5,017,508	5,063,307	5,381,025	6,259,123 B1	6,534,343	6,710,405 B2	6,759,692	7,063,975 B2	
4,881,106	5,034,796	5,187,117	5,486,715	6,306,728 B1	6,583,505	6,710,463	6,771,478 B2	7,071,537	

**Fig. 1. Output Characteristics @  $T_J = 25^\circ\text{C}$** 

**Fig. 2. Extended Output Characteristics @  $T_J = 25^\circ\text{C}$** 

**Fig. 3. Output Characteristics @  $T_J = 125^\circ\text{C}$** 

**Fig. 4.  $R_{DS(on)}$  Normalized to  $I_D = 120\text{A}$  Value vs. Junction Temperature**

**Fig. 5.  $R_{DS(on)}$  Normalized to  $I_D = 120\text{A}$  Value vs. Drain Current**

**Fig. 6. Normalized Breakdown & Threshold Voltages vs. Junction Temperature**


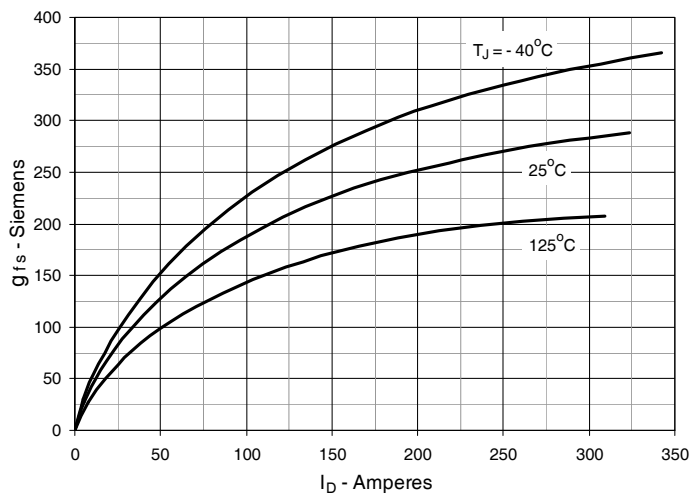
**Fig. 7. Maximum Drain Current vs. Case Temperature**



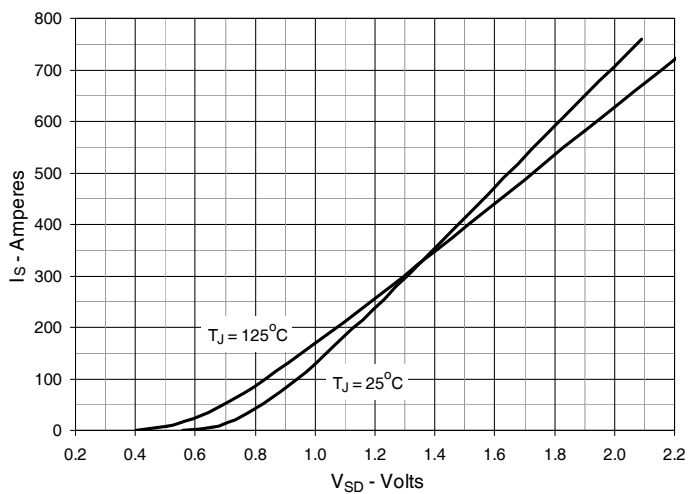
**Fig. 8. Input Admittance**



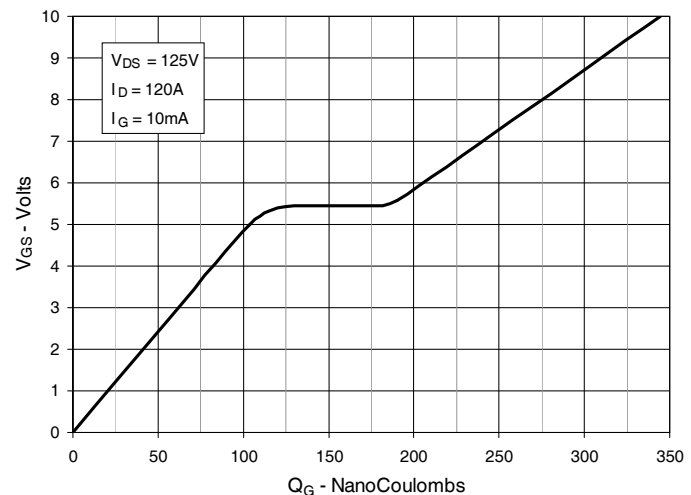
**Fig. 9. Transconductance**



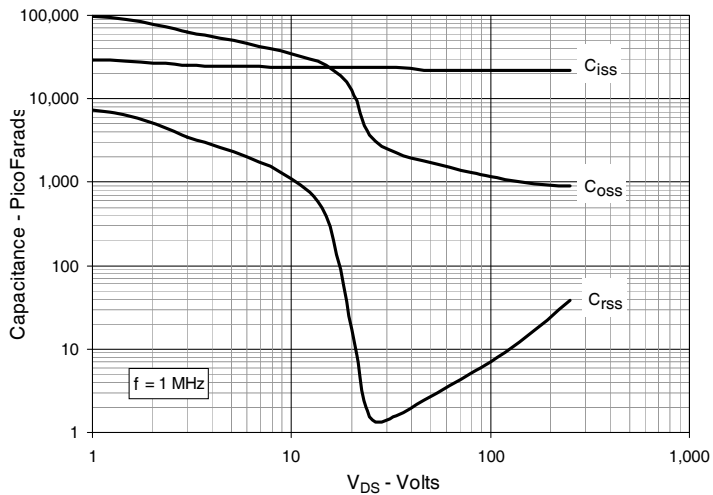
**Fig. 10. Forward Voltage Drop of Intrinsic Diode**



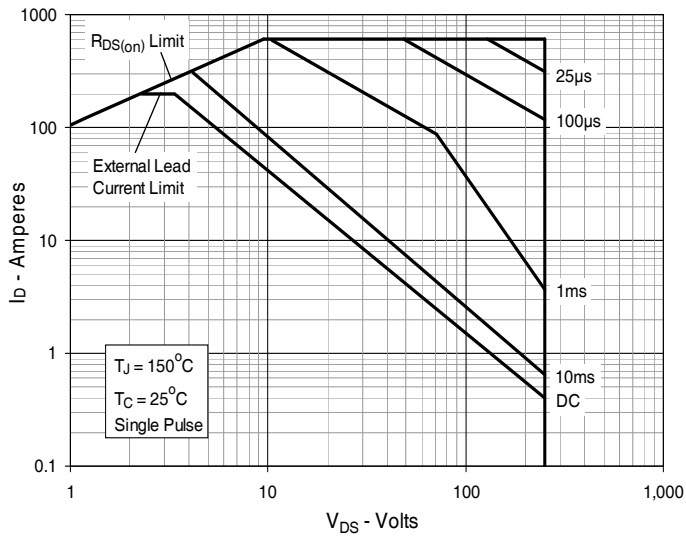
**Fig. 11. Gate Charge**



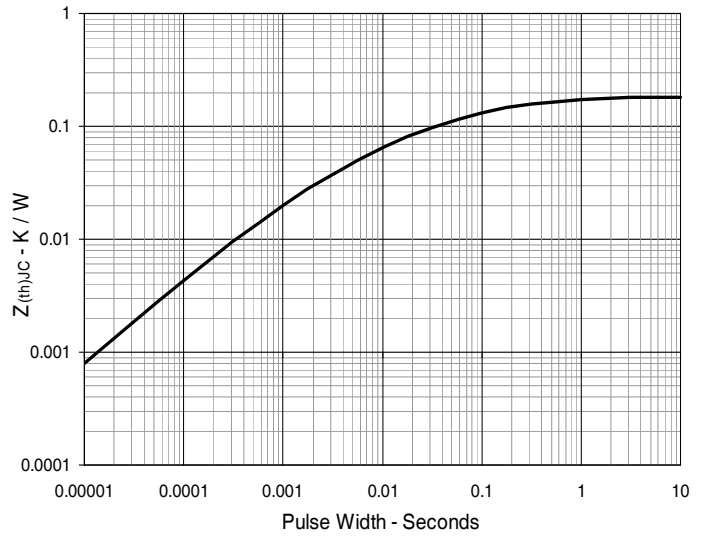
**Fig. 12. Capacitance**

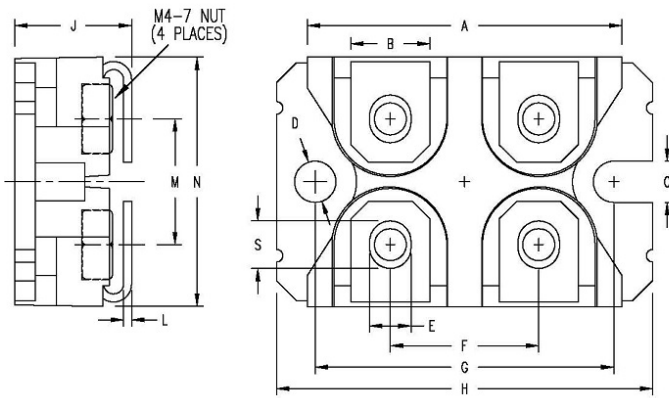


**Fig. 13. Forward-Bias Safe Operating Area**

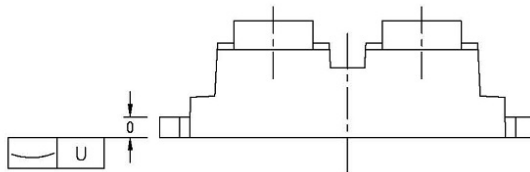


**Fig. 14. Maximum Transient Thermal Impedance**



**SOT-227 Outline**


SYM	INCHES		MILLIMETERS	
	MIN	MAX	MIN	MAX
A	1.224	1.260	31.10	32.00
B	.303	.327	7.70	8.30
C	.161	.173	4.10	4.40
D	.161	.173	4.10	4.40
E	.161	.173	4.10	4.40
F	.587	.598	14.90	15.20
G	1.181	1.201	30.00	30.50
H	1.488	1.508	37.80	38.30
J	.461	.484	11.70	12.30
L	.030	.033	0.75	0.85
M	.492	.512	12.50	13.00
N	.984	1.004	25.00	25.50
O	.075	.087	1.90	2.20
S	.181	.193	4.60	4.90
U	.000	.005	0.00	0.13



- NUT MATERIAL:**  
 STANDARD - Low carbon steel with Ni plating.  
 OPTIONAL - Brass Nut is available.  
 PART NUMBER-BN
- ALL METAL SURFACE ARE PRE NI PLATED EXCEPT TRIM AREA.**



---

Disclaimer Notice - Information furnished is believed to be accurate and reliable. However, users should independently evaluate the suitability of and test each product selected for their own applications. Littelfuse products are not designed for, and may not be used in, all applications. Read complete Disclaimer Notice at [www.littelfuse.com/disclaimer-electronics](http://www.littelfuse.com/disclaimer-electronics).

---