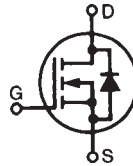

**X2-Class  
Power MOSFET**

N-Channel Enhancement Mode

**IXTU8N70X2  
IXTY8N70X2  
IXTA8N70X2  
IXTP8N70X2**

| Symbol        | Test Conditions  | Maximum Ratings    |                  |
|---------------|--|--------------------|------------------|
| $V_{DSS}$     | $T_J = 25^\circ\text{C}$ to $150^\circ\text{C}$                              | 700                | V                |
| $V_{DGR}$     | $T_J = 25^\circ\text{C}$ to $150^\circ\text{C}$ , $R_{GS} = 1\text{M}\Omega$ | 700                | V                |
| $V_{GSS}$     | Continuous   | $\pm 30$           | V                |
| $V_{GSM}$     | Transient  | $\pm 40$           | V                |
| $I_{D25}$     | $T_C = 25^\circ\text{C}$   | 8                  | A                |
| $I_{DM}$      | $T_C = 25^\circ\text{C}$ , Pulse Width Limited by $T_{JM}$                   | 16                 | A                |
| $I_A$         | $T_C = 25^\circ\text{C}$   | 4                  | A                |
| $E_{AS}$      | $T_C = 25^\circ\text{C}$   | 250                | mJ               |
| dv/dt         | $I_S \leq I_{DM}$ , $V_{DD} \leq V_{DSS}$ , $T_J \leq 150^\circ\text{C}$     | 50                 | V/ns             |
| $P_D$         | $T_C = 25^\circ\text{C}$   | 150                | W                |
| $T_J$         |  | -55 ... +150       | $^\circ\text{C}$ |
| $T_{JM}$      |  | 150                | $^\circ\text{C}$ |
| $T_{stg}$     |  | -55 ... +150       | $^\circ\text{C}$ |
| $T_L$         | Maximum Lead Temperature for Soldering                                       | 300                | $^\circ\text{C}$ |
| $T_{SOLD}$    | 1.6 mm (0.062in.) from Case for 10s  | 260                | $^\circ\text{C}$ |
| $F_C$         | Mounting Force (TO-263 & TO-251)   | 10..65 / 2.2..14.6 | N/lb             |
| $M_d$         | Mounting Torque (TO-220)   | 1.13 / 10          | Nm/lb.in         |
| <b>Weight</b> | TO-251   | 0.40               | g                |
|               | TO-252   | 0.35               | g                |
|               | TO-263   | 2.50               | g                |
|               | TO-220   | 3.00               | g                |

| Symbol       | Test Conditions<br>( $T_J = 25^\circ\text{C}$ , Unless Otherwise Specified) | Characteristic Values |      |                                       |
|--------------|---|-----------------------|------|---------------------------------------|
|              |   | Min.                  | Typ. | Max.                                  |
| $BV_{DSS}$   | $V_{GS} = 0\text{V}$ , $I_D = 250\mu\text{A}$                               | 700                   |      | V                                     |
| $V_{GS(th)}$ | $V_{DS} = V_{GS}$ , $I_D = 250\mu\text{A}$                                  | 3.0                   |      | 5.0 V                                 |
| $I_{GSS}$    | $V_{GS} = \pm 30\text{V}$ , $V_{DS} = 0\text{V}$                            |                       |      | $\pm 100$ nA                          |
| $I_{DSS}$    | $V_{DS} = V_{DSS}$ , $V_{GS} = 0\text{V}$<br>$T_J = 125^\circ\text{C}$      |                       |      | 10 $\mu\text{A}$<br>250 $\mu\text{A}$ |
| $R_{DS(on)}$ | $V_{GS} = 10\text{V}$ , $I_D = 0.5 \cdot I_{D25}$ , Note 1                  |                       |      | 500 m $\Omega$                        |

$$V_{DSS} = 700\text{V}$$

$$I_{D25} = 8\text{A}$$

$$R_{DS(on)} \leq 500\text{m}\Omega$$

TO-251 (IXTU)

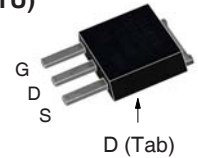

TO-252 (IXTY)

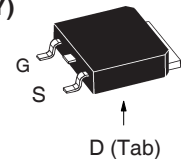

TO-263 (IXTA)

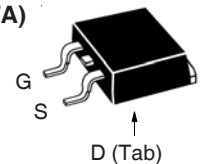

TO-220 (IXTP)

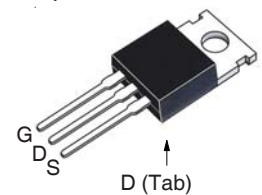
 G = Gate      D = Drain  
 S = Source    Tab = Drain

**Features**

- International Standard Packages
- Low  $R_{DS(ON)}$  and  $Q_G$
- Avalanche Rated
- Low Package Inductance

**Advantages**

- High Power Density
- Easy to Mount
- Space Savings

**Applications**

- Switch-Mode and Resonant-Mode Power Supplies
- DC-DC Converters
- PFC Circuits
- AC and DC Motor Drives
- Robotics and Servo Controls

| Symbol                              | Test Conditions<br>( $T_J = 25^\circ\text{C}$ , Unless Otherwise Specified)                                     | Characteristic Values                                |      |                         |
|-------------------------------------|---|--|------|-------------------------|
|                                     |   | Min.   | Typ. | Max                     |
| $g_{fs}$                            | $V_{DS} = 10\text{V}$ , $I_D = 0.5 \cdot I_{D25}$ , Note 1  | 4.8  | 8.0  | S                       |
| $R_{Gi}$                            | Gate Input Resistance   |  | 6    | $\Omega$                |
| $C_{iss}$                           | $V_{GS} = 0\text{V}$ , $V_{DS} = 25\text{V}$ , $f = 1\text{MHz}$  |  | 800  | pF                      |
| $C_{oss}$                           |   |  | 495  | pF                      |
| $C_{rss}$                           |   |  | 2.2  | pF                      |
| <b>Effective Output Capacitance</b> |   |  |      |                         |
| $C_{o(er)}$                         | Energy related  | $V_{GS} = 0\text{V}$<br>$V_{DS} = 0.8 \cdot V_{DSS}$ | 43   | pF                      |
| $C_{o(tr)}$                         | Time related  |  | 129  | pF                      |
| <b>Resistive Switching Times</b>    |   |  |      |                         |
| $t_{d(on)}$                         | $V_{GS} = 10\text{V}$ , $V_{DS} = 0.5 \cdot V_{DSS}$ , $I_D = 0.5 \cdot I_{D25}$<br>$R_G = 30\Omega$ (External) |  | 24   | ns                      |
| $t_r$                               |   |  | 28   | ns                      |
| $t_{d(off)}$                        |   |  | 53   | ns                      |
| $t_f$                               |   |  | 24   | ns                      |
| $Q_{g(on)}$                         | $V_{GS} = 10\text{V}$ , $V_{DS} = 0.5 \cdot V_{DSS}$ , $I_D = 0.5 \cdot I_{D25}$                                |  | 12.0 | nC                      |
| $Q_{gs}$                            |   |  | 3.1  | nC                      |
| $Q_{gd}$                            |   |  | 4.4  | nC                      |
| $R_{thJC}$                          | TO-220  |  |      | 0.83 $^\circ\text{C/W}$ |
| $R_{thCS}$                          |   |  | 0.50 | $^\circ\text{C/W}$      |

### Source-Drain Diode

| Symbol   | Test Conditions<br>( $T_J = 25^\circ\text{C}$ , Unless Otherwise Specified)   | Characteristic Values |      |               |
|----------|---|-----------------------|------|---------------|
|          |   | Min.                  | Typ. | Max           |
| $I_S$    | $V_{GS} = 0\text{V}$  |                       |      | 8 A           |
| $I_{SM}$ | Repetitive, pulse Width Limited by $T_{JM}$                                   |                       |      | 32 A          |
| $V_{SD}$ | $I_F = I_S$ , $V_{GS} = 0\text{V}$ , Note 1                                   |                       |      | 1.4 V         |
| $t_{rr}$ | $I_F = 4\text{A}$ , $-di/dt = 100\text{A}/\mu\text{s}$<br>$V_R = 100\text{V}$ |                       | 200  | ns            |
| $Q_{RM}$ |   |                       | 1.65 | $\mu\text{C}$ |
| $I_{RM}$ |   |                       | 16.3 | A             |

Note 1. Pulse test,  $t \leq 300\mu\text{s}$ , duty cycle,  $d \leq 2\%$ .

### PRELIMINARY TECHNICAL INFORMATION

The product presented herein is under development. The Technical Specifications offered are derived from a subjective evaluation of the design, based upon prior knowledge and experience, and constitute a "considered reflection" of the anticipated result. IXYS reserves the right to change limits, test conditions, and dimensions without notice.

IXYS Reserves the Right to Change Limits, Test Conditions, and Dimensions.

|  |           |           |           |           |             |             |             |             |             |             |
|--|-----------|-----------|-----------|-----------|-------------|-------------|-------------|-------------|-------------|-------------|
| IXYS MOSFETs and IGBTs are covered by one or more of the following U.S. patents: | 4,835,592 | 4,931,844 | 5,049,961 | 5,237,481 | 6,162,665   | 6,404,065B1 | 6,683,344   | 6,727,585   | 7,005,734B2 | 7,157,338B2 |
|  | 4,860,072 | 5,017,508 | 5,063,307 | 5,381,025 | 6,259,123B1 | 6,534,343   | 6,710,405B2 | 6,759,692   | 7,063,975B2 |             |
|  | 4,881,106 | 5,034,796 | 5,187,117 | 5,486,715 | 6,306,728B1 | 6,583,505   | 6,710,463   | 6,771,478B2 | 7,071,537   |             |

Fig. 1. Output Characteristics @  $T_J = 25^\circ\text{C}$

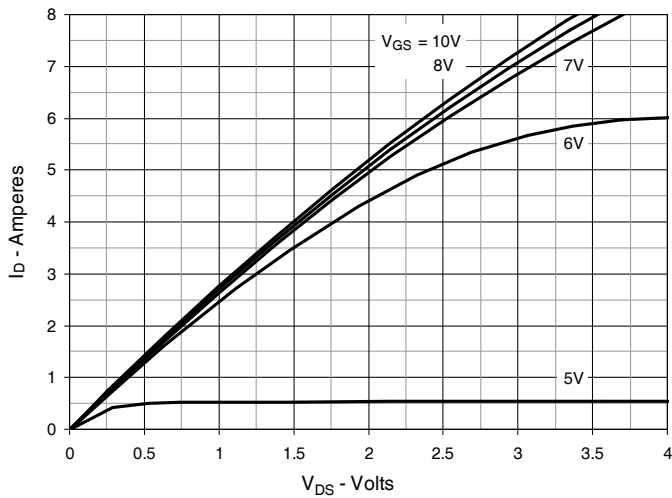

Fig. 2. Extended Output Characteristics @  $T_J = 25^\circ\text{C}$

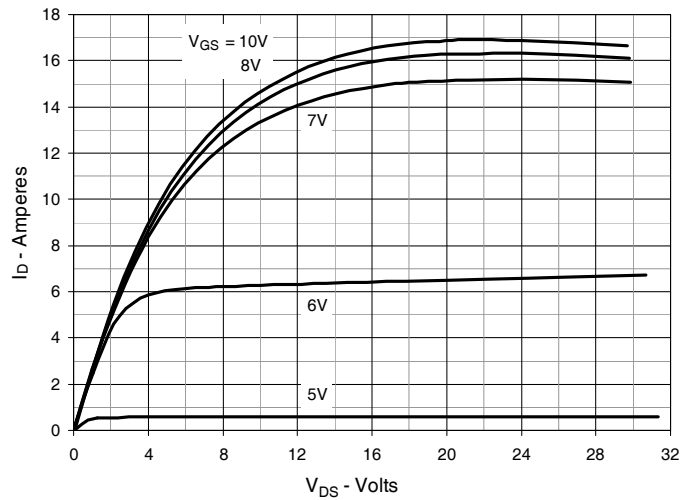

Fig. 3. Output Characteristics @  $T_J = 125^\circ\text{C}$

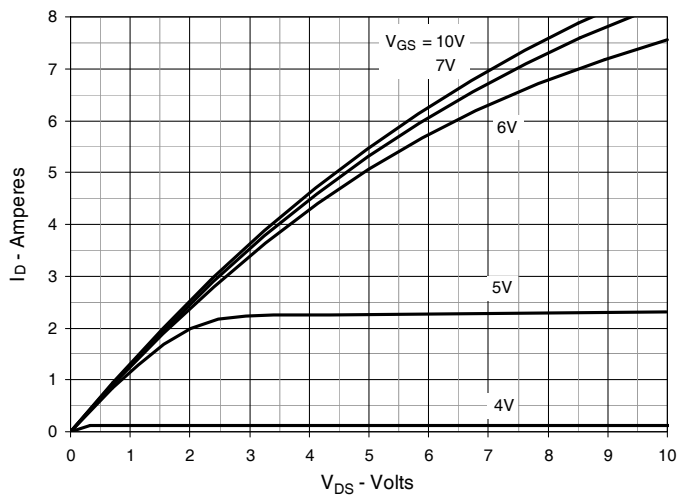

Fig. 4.  $R_{DS(on)}$  Normalized to  $I_D = 4\text{A}$  Value vs. Junction Temperature

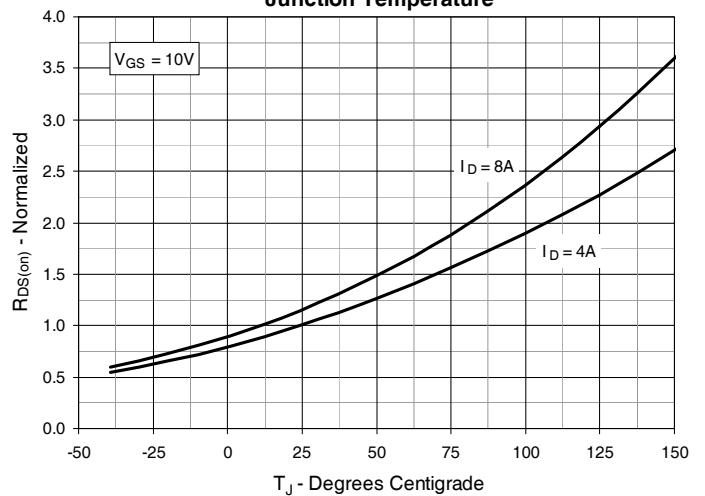

Fig. 5.  $R_{DS(on)}$  Normalized to  $I_D = 4\text{A}$  Value vs. Drain Current

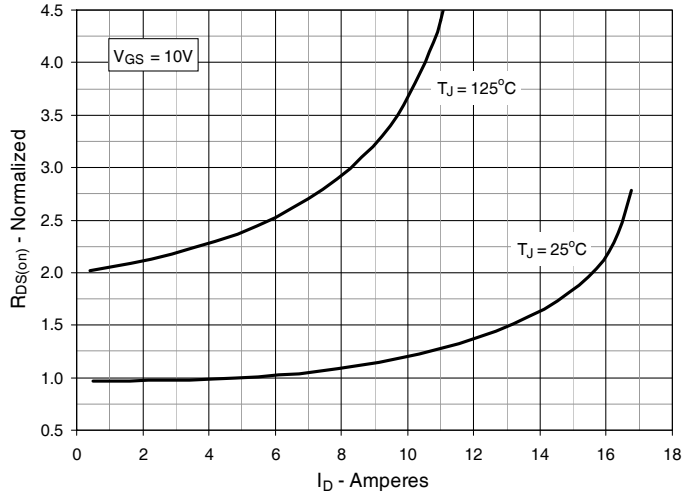

Fig. 6. Maximum Drain Current vs. Case Temperature

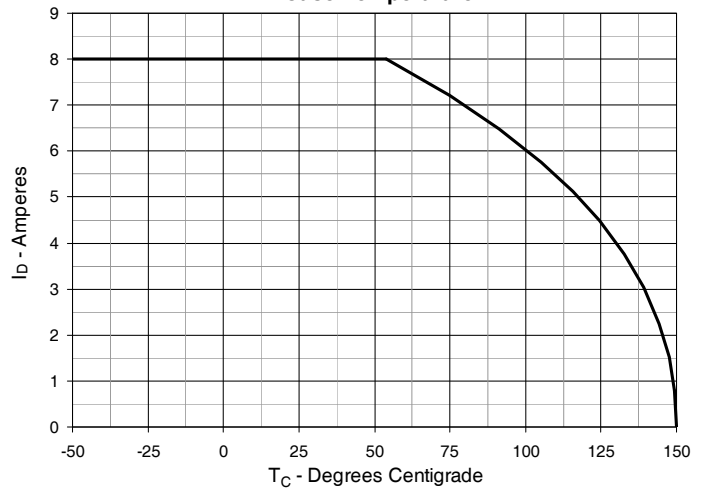

Fig. 7. Input Admittance

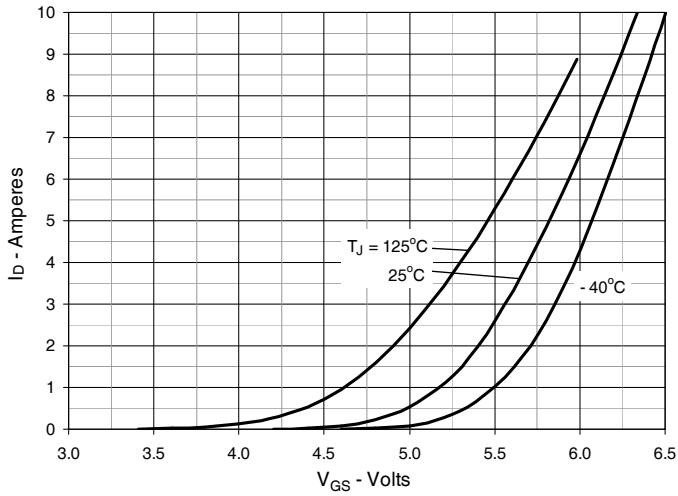

Fig. 8. Transconductance

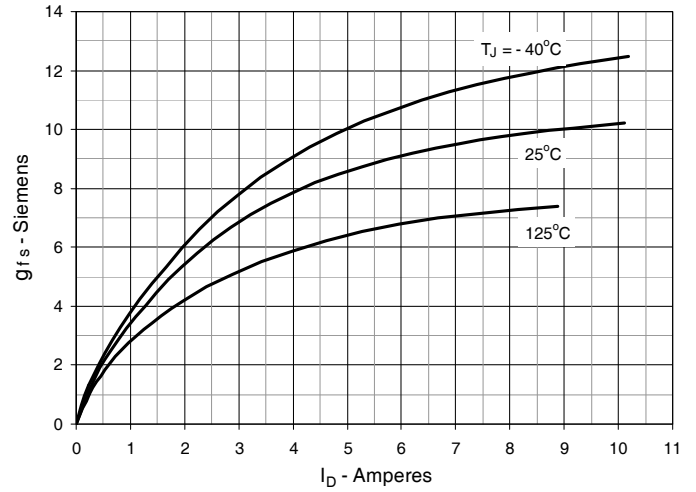

Fig. 9. Forward Voltage Drop of Intrinsic Diode

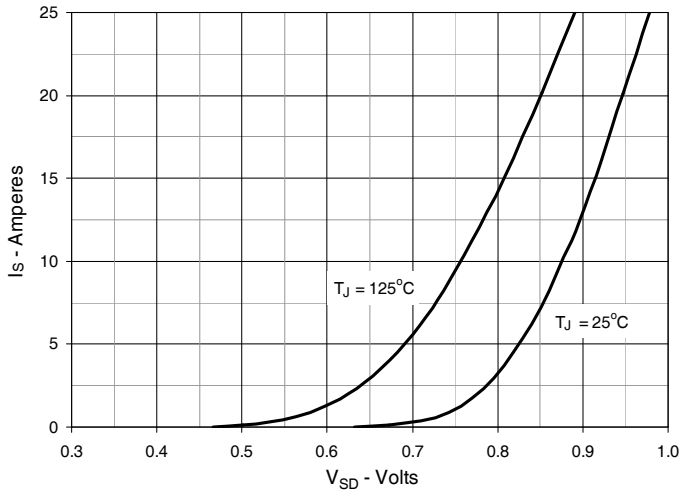

Fig. 10. Gate Charge

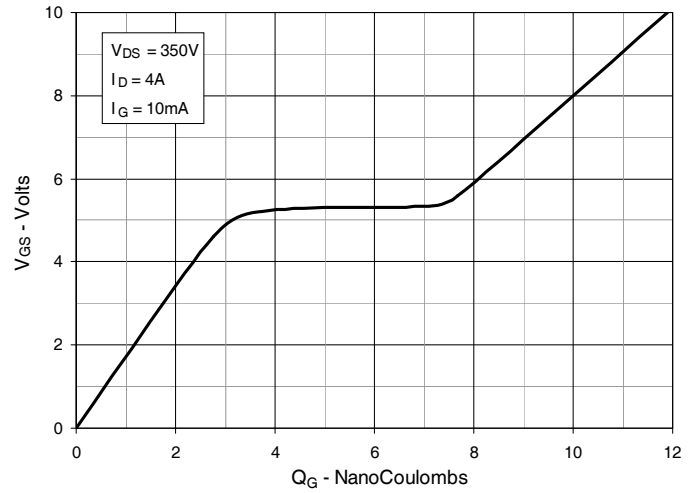

Fig. 11. Capacitance

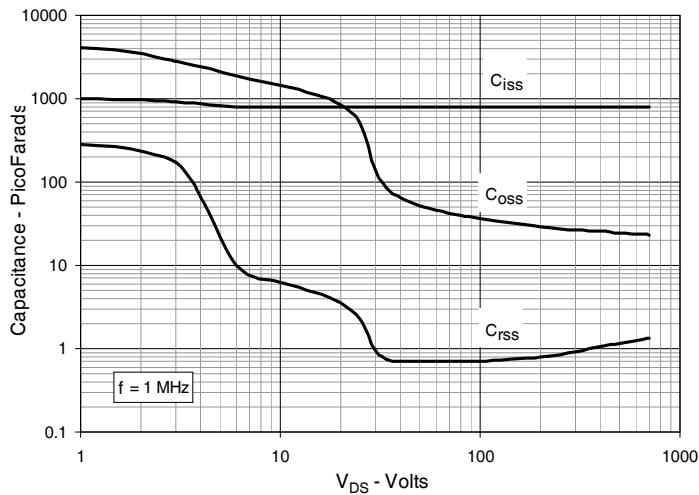

Fig. 12. Output Capacitance Stored Energy

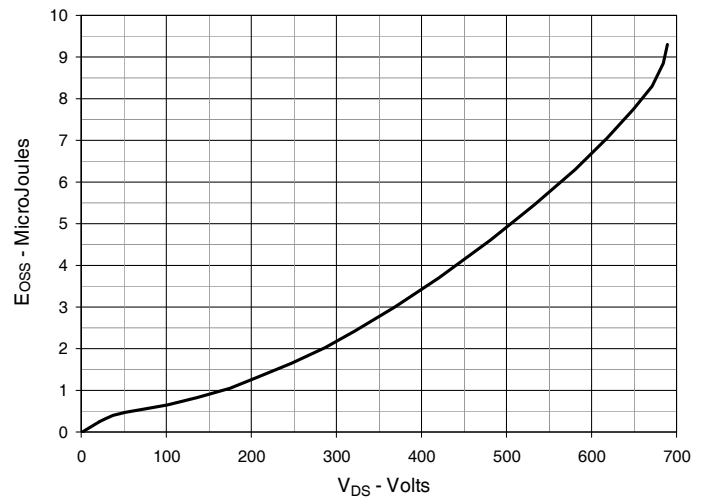

Fig. 13. Forward-Bias Safe Operating Area

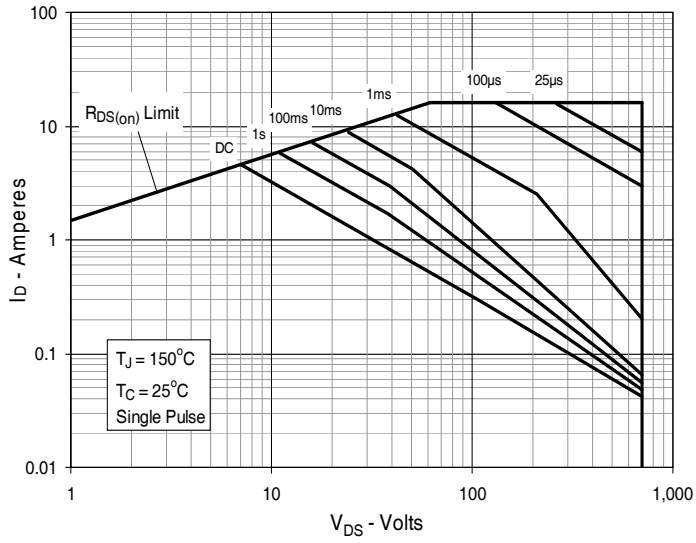
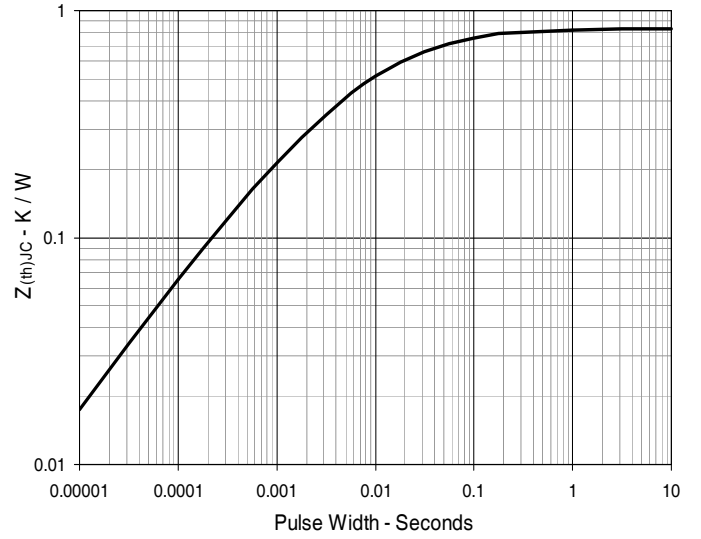
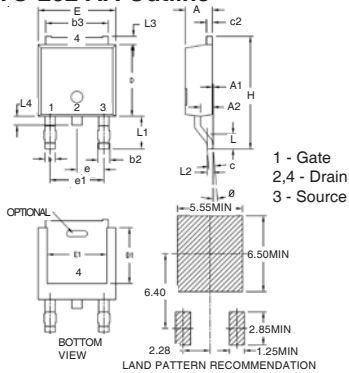

Fig. 14. Maximum Transient Thermal Impedance



### TO-252 AA Outline



| SYM | INCHES   |      | MILLIMETERS |       |
|-----|----------|------|-------------|-------|
|     | MIN      | MAX  | MIN         | MAX   |
| A   | .086     | .094 | 2.19        | 2.38  |
| A1  | 0        | .005 | 0           | 0.12  |
| A2  | .038     | .046 | 0.97        | 1.17  |
| b   | .025     | .035 | 0.64        | 0.89  |
| b2  | .030     | .045 | 0.76        | 1.14  |
| b3  | .200     | .215 | 5.08        | 5.46  |
| c   | .018     | .024 | 0.46        | 0.61  |
| c2  | .018     | .023 | 0.46        | 0.58  |
| D   | .235     | .245 | 5.97        | 6.22  |
| D1  | .180     | .205 | 4.57        | 5.21  |
| E   | .250     | .265 | 6.35        | 6.73  |
| E1  | .170     | .205 | 4.32        | 5.21  |
| e   | .090 BSC |      | 2.28 BSC    |       |
| e1  | .180 BSC |      | 4.57 BSC    |       |
| H   | .370     | .410 | 9.40        | 10.42 |
| L   | .055     | .070 | 1.40        | 1.78  |
| L1  | .100     | .115 | 2.54        | 2.92  |
| L2  | .020 BSC |      | 0.50 BSC    |       |
| L3  | .025     | .040 | 0.64        | 1.02  |
| L4  | .025     | .040 | 0.64        | 1.02  |
| θ   | 0° - 10° |      | 0° - 10°    |       |

### TO-263 Outline

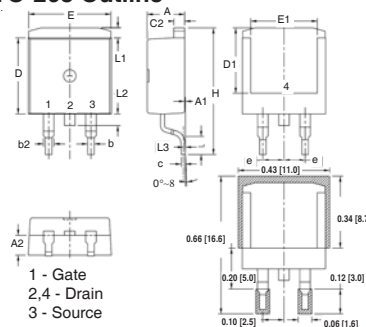

| SYM | INCHES   |      | MILLIMETER |       |
|-----|----------|------|------------|-------|
|     | MIN      | MAX  | MIN        | MAX   |
| A   | .170     | .185 | 4.30       | 4.70  |
| A1  | .000     | .008 | 0.00       | 0.20  |
| A2  | .091     | .098 | 2.30       | 2.50  |
| b   | .028     | .035 | 0.70       | 0.90  |
| b2  | .046     | .060 | 1.18       | 1.52  |
| C   | .018     | .024 | 0.45       | 0.60  |
| C2  | .049     | .060 | 1.25       | 1.52  |
| D   | .340     | .370 | 8.63       | 9.40  |
| D1  | .300     | .327 | 7.62       | 8.30  |
| E   | .380     | .410 | 9.65       | 10.41 |
| E1  | .270     | .330 | 6.86       | 8.38  |
| e   | .100 BSC |      | 2.54 BSC   |       |
| H   | .580     | .620 | 14.73      | 15.75 |
| L   | .075     | .105 | 1.91       | 2.67  |
| L1  | .039     | .060 | 1.00       | 1.52  |
| L2  | —        | .070 | —          | 1.77  |
| L3  | .010 BSC |      | 0.254 BSC  |       |

### TO-220 Outline

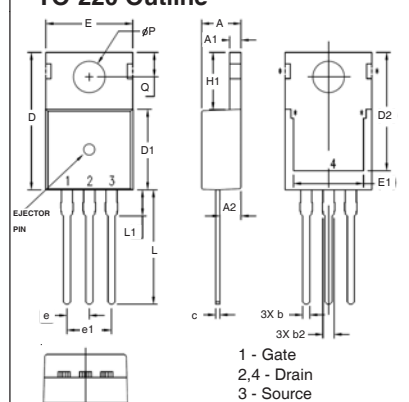

| SYM  | INCHES   |      | MILLIMETERS |       |
|------|----------|------|-------------|-------|
|      | MIN      | MAX  | MIN         | MAX   |
| A    | .169     | .185 | 4.30        | 4.70  |
| A1   | .047     | .055 | 1.20        | 1.40  |
| A2   | .079     | .106 | 2.00        | 2.70  |
| b    | .024     | .039 | 0.60        | 1.00  |
| b2   | .045     | .057 | 1.15        | 1.45  |
| c    | .014     | .026 | 0.35        | 0.65  |
| D    | .587     | .626 | 14.90       | 15.90 |
| D1   | .335     | .370 | 8.50        | 9.40  |
| (D2) | .500     | .531 | 12.70       | 13.50 |
| E    | .382     | .406 | 9.70        | 10.30 |
| (E1) | .283     | .323 | 7.20        | 8.20  |
| e    | .100 BSC |      | 2.54 BSC    |       |
| e1   | .200 BSC |      | 5.08 BSC    |       |
| H1   | .244     | .268 | 6.20        | 6.80  |
| L    | .492     | .547 | 12.50       | 13.90 |
| L1   | .110     | .154 | 2.80        | 3.90  |
| ∅P   | .134     | .150 | 3.40        | 3.80  |
| Q    | .106     | .126 | 2.70        | 3.20  |

### TO-251 OUTLINE

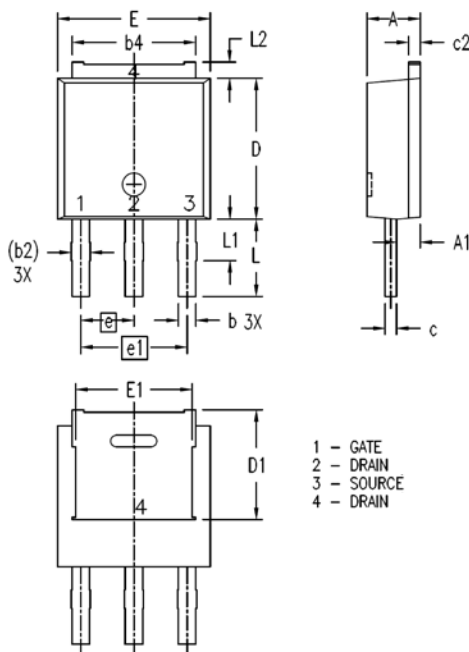

| SYM  | INCHES   |      | MILLIMETERS |      |
|------|----------|------|-------------|------|
|      | MIN      | MAX  | MIN         | MAX  |
| A    | .087     | .094 | 2.20        | 2.40 |
| A1   | .032     | .048 | 0.82        | 1.22 |
| b    | .026     | .034 | 0.66        | 0.86 |
| (b2) | .030     | .035 | 0.76        | 0.88 |
| b4   | .198     | .222 | 5.04        | 5.64 |
| c    | .018     | .024 | 0.45        | 0.60 |
| c2   | .016     | .024 | 0.40        | 0.60 |
| D    | .232     | .248 | 5.90        | 6.30 |
| (D1) | .179     | .195 | 4.55        | 4.95 |
| E    | .252     | .268 | 6.40        | 6.80 |
| (E1) | .191     | .207 | 4.85        | 5.25 |
| e    | .090 BSC |      | 2.28 BSC    |      |
| e1   | .180 BSC |      | 4.57 BSC    |      |
| L    | .126     | .138 | 3.20        | 3.50 |
| L1   | .063     | .079 | 1.60        | 2.00 |
| L2   | .020     | .035 | 0.50        | 0.90 |



---

Disclaimer Notice - Information furnished is believed to be accurate and reliable. However, users should independently evaluate the suitability of and test each product selected for their own applications. Littelfuse products are not designed for, and may not be used in, all applications. Read complete Disclaimer Notice at [www.littelfuse.com/disclaimer-electronics](http://www.littelfuse.com/disclaimer-electronics).