

TrenchP™ Power MOSFETs

P-Channel Enhancement Mode
Avalanche Rated

IXTA44P15T
IXTP44P15T
IXTQ44P15T
IXTH44P15T

$V_{DSS} = -150V$
 $I_{D25} = -44A$
 $R_{DS(on)} \leq 65m\Omega$

TO-263 AA (IXTA)

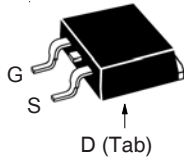

TO-220AB (IXTP)

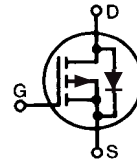
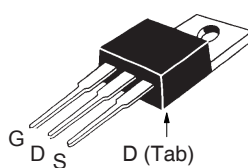

TO-3P (IXTQ)

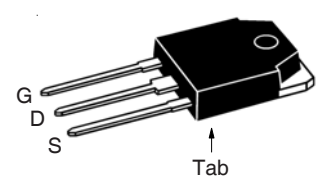

TO-247 (IXTH)

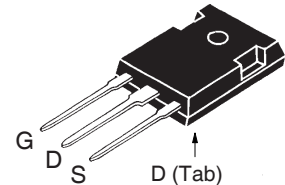

G = Gate D = Drain
S = Source Tab = Drain

| Symbol | Test Conditions | Maximum Ratings | |
|-------------|---|-----------------|------------|
| V_{DSS} | $T_J = 25^\circ C$ to $150^\circ C$ | - 150 | V |
| V_{DGR} | $T_J = 25^\circ C$ to $150^\circ C$, $R_{GS} = 1M\Omega$ | - 150 | V |
| V_{GSS} | Continuous | ± 15 | V |
| V_{GSM} | Transient | ± 25 | V |
| I_{D25} | $T_C = 25^\circ C$ | - 44 | A |
| I_{DM} | $T_C = 25^\circ C$, Pulse Width Limited by T_{JM} | -130 | A |
| I_A | $T_C = 25^\circ C$ | - 22 | A |
| E_{AS} | $T_C = 25^\circ C$ | 1 | J |
| P_D | $T_C = 25^\circ C$ | 298 | W |
| T_J | | -55 ... +150 | $^\circ C$ |
| T_{JM} | | 150 | $^\circ C$ |
| T_{stg} | | -55 ... +150 | $^\circ C$ |
| T_L | 1.6mm (0.062 in.) from Case for 10s | 300 | $^\circ C$ |
| $T_{SO LD}$ | Plastic Body for 10s | 260 | $^\circ C$ |
| M_d | Mounting Torque (TO-220, TO-247 & TO-3P) | 1.13/10 | Nm/lb.in. |
| Weight | TO-263 | 2.5 | g |
| | TO-220 | 3.0 | g |
| | TO-3P | 5.5 | g |
| | TO-247 | 6.0 | g |

Features

- International Standard Packages
- Avalanche Rated
- Extended FBSOA
- Fast Intrinsic Diode
- Low $R_{DS(ON)}$ and Q_G

Advantages

- Easy to Mount
- Space Savings
- High Power Density

Applications

- High-Side Switching
- Push Pull Amplifiers
- DC Choppers
- Automatic Test Equipment
- Current Regulators
- Battery Charger Applications

| Symbol | Test Conditions ($T_J = 25^\circ C$, Unless Otherwise Specified) | Characteristic Values | | |
|--------------|---|-----------------------|------|-------------------------------|
| | | Min. | Typ. | Max. |
| BV_{DSS} | $V_{GS} = 0V$, $I_D = -250\mu A$ | -150 | | V |
| $V_{GS(th)}$ | $V_{DS} = V_{GS}$, $I_D = -250\mu A$ | - 2.0 | | V |
| I_{GSS} | $V_{GS} = \pm 15V$, $V_{DS} = 0V$ | | | ± 100 nA |
| I_{DSS} | $V_{DS} = V_{DSS}$, $V_{GS} = 0V$ $T_J = 125^\circ C$ | | | - 15 μA - 750 μA |
| $R_{DS(on)}$ | $V_{GS} = -10V$, $I_D = 0.5 \cdot I_{D25}$, Note 1 | | | 65 m Ω |

| Symbol | Test Conditions ($T_J = 25^\circ\text{C}$, Unless Otherwise Specified) | Characteristic Values | | |
|---|---|-----------------------|--------------|--|
| | | Min. | Typ. | Max. |
| g_{fs} | $V_{DS} = -10\text{V}$, $I_D = 0.5 \cdot I_{D25}$, Note 1 | 27 | 45 | S |
| C_{iss} C_{oss} C_{rss} | $V_{GS} = 0\text{V}$, $V_{DS} = -25\text{V}$, $f = 1\text{MHz}$ | | 13.4 | nF |
| | | | 675 | pF |
| | | | 183 | pF |
| $t_{d(on)}$ t_r $t_{d(off)}$ t_f | Resistive Switching Times $V_{GS} = -10\text{V}$, $V_{DS} = 0.5 \cdot V_{DSS}$, $I_D = 0.5 \cdot I_{D25}$ $R_G = 1\Omega$ (External) | | 25 | ns |
| | | | 42 | ns |
| | | | 50 | ns |
| | | | 17 | ns |
| $Q_{g(on)}$ Q_{gs} Q_{gd} | $V_{GS} = -10\text{V}$, $V_{DS} = 0.5 \cdot V_{DSS}$, $I_D = 0.5 \cdot I_{D25}$ | | 175 | nC |
| | | | 65 | nC |
| | | | 58 | nC |
| R_{thJC} R_{thCS} | TO-220 TO-247 & TO-3P | | 0.42 | $^\circ\text{C/W}$ |
| | | | 0.50 0.21 | $^\circ\text{C/W}$ $^\circ\text{C/W}$ |

Source-Drain Diode

| Symbol | Test Conditions ($T_J = 25^\circ\text{C}$, Unless Otherwise Specified) | Characteristic Values | | |
|----------------------------------|---|-----------------------|-------|---------------|
| | | Min. | Typ. | Max. |
| I_S | $V_{GS} = 0\text{V}$ | | | -44 A |
| I_{SM} | Repetitive, Pulse Width Limited by T_{JM} | | | -176 A |
| V_{SD} | $I_F = I_S$, $V_{GS} = 0\text{V}$, Note 1 | | | -1.3 V |
| t_{rr} Q_{RM} I_{RM} | $I_F = -22\text{A}$, $-di/dt = -100\text{A}/\mu\text{s}$ $V_R = -75\text{V}$, $V_{GS} = 0\text{V}$ | | 140 | ns |
| | | | 0.87 | μC |
| | | | -12.4 | A |

Note 1. Pulse test, $t \leq 300\mu\text{s}$, duty cycle, $d \leq 2\%$.

IXYS Reserves the Right to Change Limits, Test Conditions, and Dimensions.

IXYS MOSFETs and IGBTs are covered by one or more of the following U.S. patents:

| | | | | | | | | | |
|-----------|-----------|-----------|-----------|--------------|--------------|--------------|--------------|--------------|-------------|
| 4,835,592 | 4,931,844 | 5,049,961 | 5,237,481 | 6,162,665 | 6,404,065 B1 | 6,683,344 | 6,727,585 | 7,005,734 B2 | 7,157,338B2 |
| 4,860,072 | 5,017,508 | 5,063,307 | 5,381,025 | 6,259,123 B1 | 6,534,343 | 6,710,405 B2 | 6,759,692 | 7,063,975 B2 | |
| 4,881,106 | 5,034,796 | 5,187,117 | 5,486,715 | 6,306,728 B1 | 6,583,505 | 6,710,463 | 6,771,478 B2 | 7,071,537 | |

TO-247 Outline

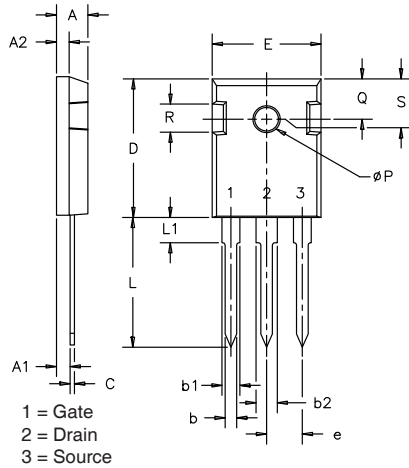

| SYM | INCHES | | MILLIMETERS | |
|-------|----------|------|-------------|-------|
| | MIN | MAX | MIN | MAX |
| A | .185 | .209 | 4.7 | 5.3 |
| A1 | .087 | .102 | 2.2 | 2.54 |
| A2 | .059 | .098 | 2.2 | 2.6 |
| b | .040 | .055 | 1.0 | 1.4 |
| b1 | .065 | .084 | 1.65 | 2.13 |
| b2 | .113 | .123 | 2.87 | 3.12 |
| C | .016 | .031 | .4 | .8 |
| D | .819 | .845 | 20.80 | 21.46 |
| E | .610 | .640 | 15.75 | 16.26 |
| e | .215 BSC | | 5.45 BSC | |
| L | .780 | .800 | 19.81 | 20.32 |
| L1 | .177 | | 4.50 | |
| phi P | .140 | .144 | 3.55 | 3.65 |
| Q | .212 | .244 | 5.4 | 6.2 |
| R | .170 | .216 | 4.32 | 5.49 |
| S | .242 BSC | | 6.15 BSC | |

TO-220 Outline

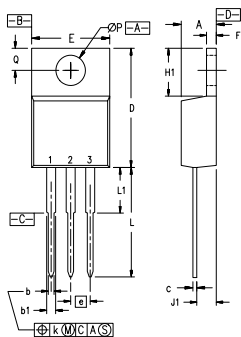

Pins: 1 - Gate 2 - Drain
3 - Source

| SYM | INCHES | | MILLIMETERS | |
|-------|----------|------|-------------|-------|
| | MIN | MAX | MIN | MAX |
| A | .170 | .190 | 4.32 | 4.83 |
| b | .025 | .040 | 0.64 | 1.02 |
| b1 | .045 | .065 | 1.15 | 1.65 |
| c | .014 | .022 | 0.35 | 0.56 |
| D | .580 | .630 | 14.73 | 16.00 |
| E | .390 | .420 | 9.91 | 10.66 |
| e | .100 BSC | | 2.54 BSC | |
| F | .045 | .055 | 1.14 | 1.40 |
| H1 | .230 | .270 | 5.85 | 6.85 |
| J1 | .090 | .110 | 2.29 | 2.79 |
| k | 0 | .015 | 0 | 0.38 |
| L | .500 | .550 | 12.70 | 13.97 |
| L1 | .110 | .230 | 2.79 | 5.84 |
| phi P | .139 | .161 | 3.53 | 4.08 |
| Q | .100 | .125 | 2.54 | 3.18 |

TO-3P Outline

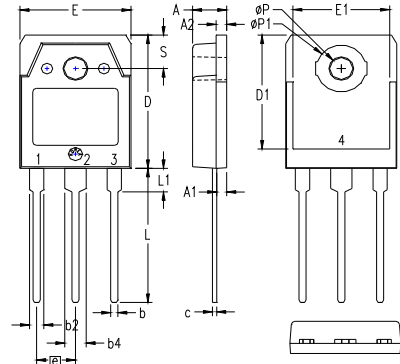

Pins: 1 - Gate 2,4 - Drain
3 - Source

| SYM | INCHES | | MILLIMETERS | |
|--------|----------|------|-------------|-------|
| | MIN | MAX | MIN | MAX |
| A | .185 | .193 | 4.70 | 4.90 |
| A1 | .051 | .059 | 1.30 | 1.50 |
| A2 | .057 | .065 | 1.45 | 1.65 |
| b | .035 | .045 | 0.90 | 1.15 |
| b2 | .075 | .087 | 1.90 | 2.20 |
| b4 | .114 | .126 | 2.90 | 3.20 |
| c | .022 | .031 | 0.55 | 0.80 |
| D | .780 | .791 | 19.80 | 20.10 |
| D1 | .665 | .677 | 16.90 | 17.20 |
| E | .610 | .622 | 15.50 | 15.80 |
| E1 | .531 | .539 | 13.50 | 13.70 |
| e | .215 BSC | | 5.45 BSC | |
| L | .779 | .795 | 19.80 | 20.20 |
| L1 | .134 | .142 | 3.40 | 3.60 |
| phi P | .126 | .134 | 3.20 | 3.40 |
| phi P1 | .272 | .280 | 6.90 | 7.10 |
| S | .193 | .201 | 4.90 | 5.10 |

All metal area are tin plated.

TO-263 Outline

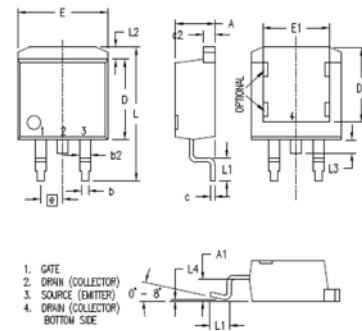

| SYM | INCHES | | MILLIMETERS | |
|-----|----------|------|-------------|-------|
| | MIN | MAX | MIN | MAX |
| A | .160 | .190 | 4.06 | 4.83 |
| A1 | .080 | .110 | 2.03 | 2.79 |
| b | .020 | .039 | 0.51 | 0.99 |
| b2 | .045 | .055 | 1.14 | 1.40 |
| c | .016 | .029 | 0.40 | 0.74 |
| c2 | .045 | .055 | 1.14 | 1.40 |
| D | .340 | .380 | 8.64 | 9.65 |
| D1 | .315 | .350 | 8.00 | 8.89 |
| E | .380 | .410 | 9.65 | 10.41 |
| E1 | .245 | .320 | 6.22 | 8.13 |
| e | .100 BSC | | 2.54 BSC | |
| L | .575 | .625 | 14.61 | 15.88 |
| L1 | .090 | .110 | 2.29 | 2.79 |
| L2 | .040 | .055 | 1.02 | 1.40 |
| L3 | .050 | .070 | 1.27 | 1.78 |
| L4 | 0 | .005 | 0 | 0.13 |

Fig. 1. Output Characteristics @ $T_J = 25^\circ\text{C}$

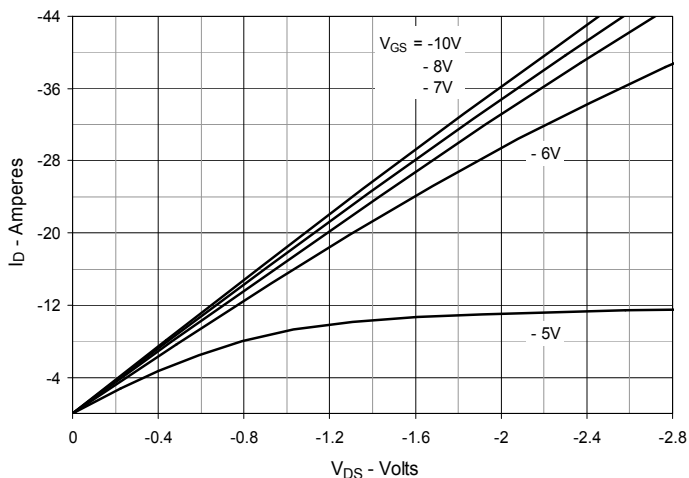

Fig. 2. Extended Output Characteristics @ $T_J = 25^\circ\text{C}$

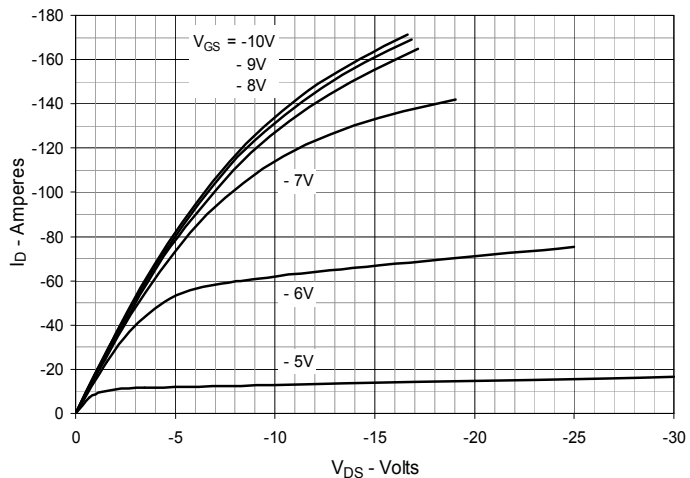

Fig. 3. Output Characteristics @ $T_J = 125^\circ\text{C}$

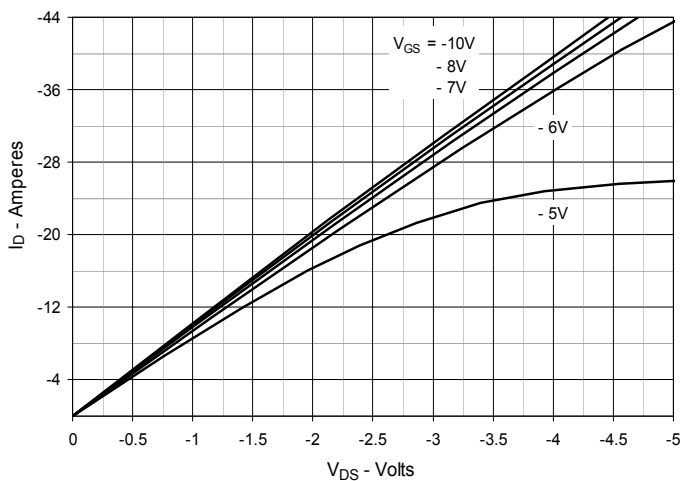

Fig. 4. $R_{DS(on)}$ Normalized to $I_D = -22\text{A}$ Value vs. Junction Temperature

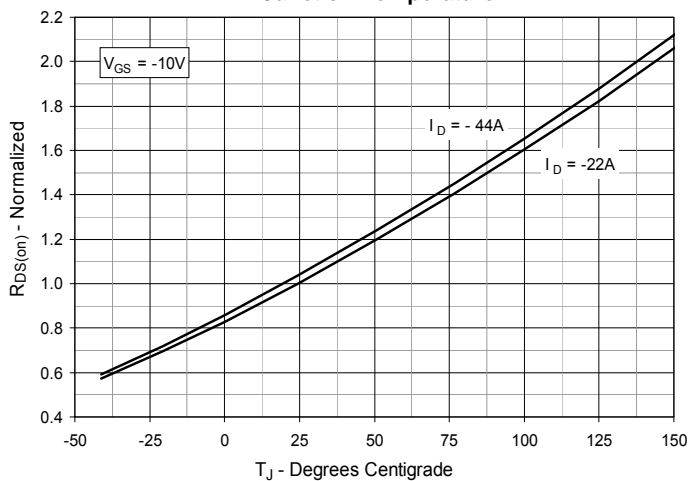

Fig. 5. $R_{DS(on)}$ Normalized to $I_D = -22\text{A}$ Value vs. Drain Current

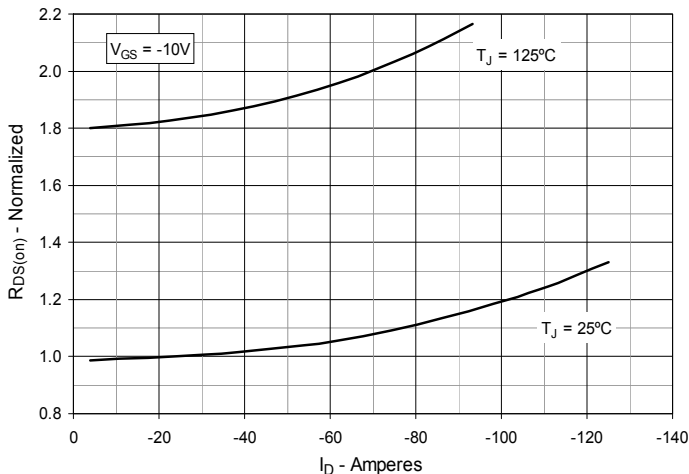

Fig. 6. Maximum Drain Current vs. Case Temperature

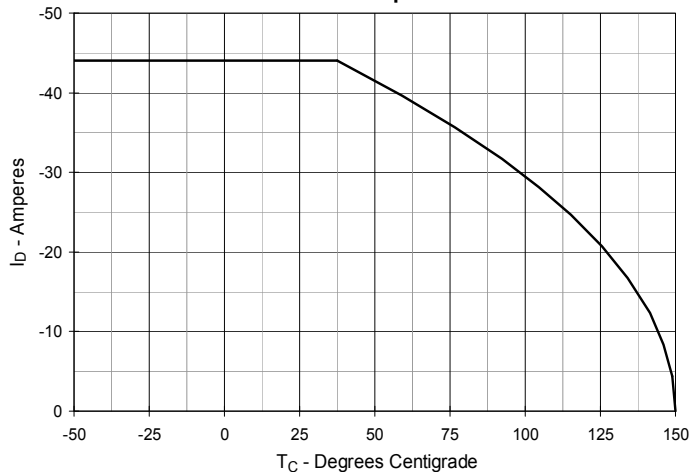

Fig. 7. Input Admittance

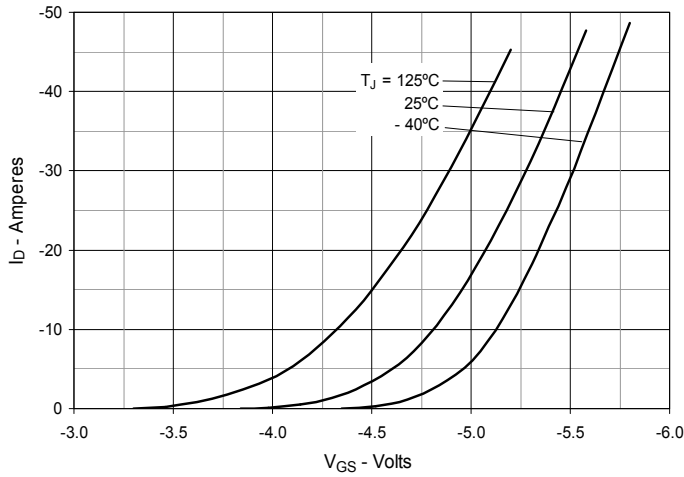

Fig. 8. Transconductance

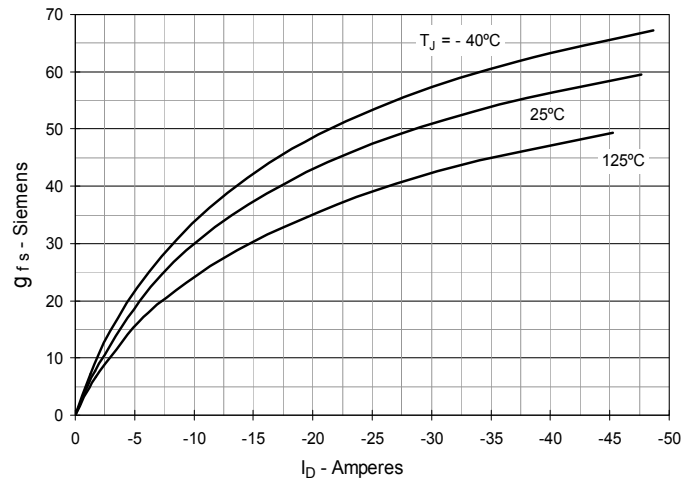

Fig. 9. Forward Voltage Drop of Intrinsic Diode

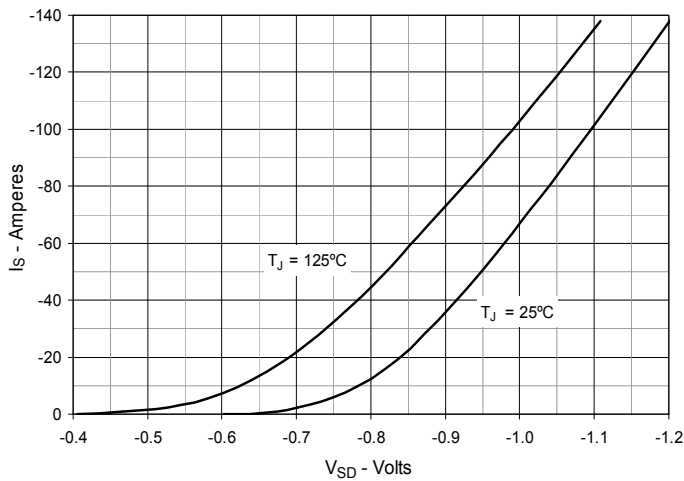

Fig. 10. Gate Charge

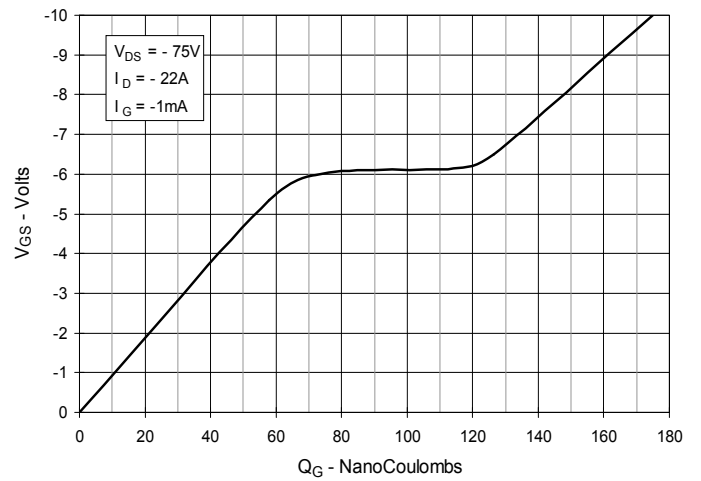

Fig. 11. Capacitance

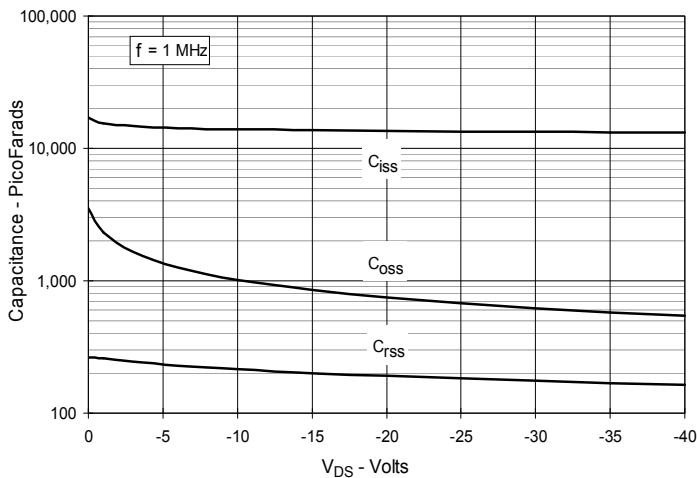

Fig. 12. Forward-Bias Safe Operating Area

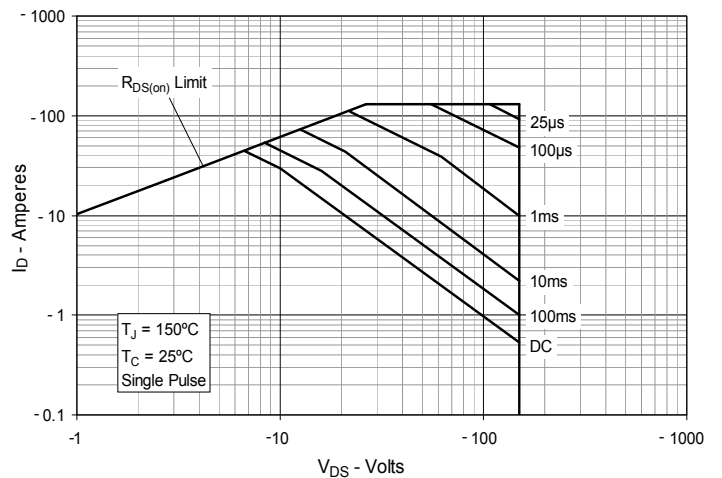

Fig. 13. Resistive Turn-on Rise Time vs. Junction Temperature

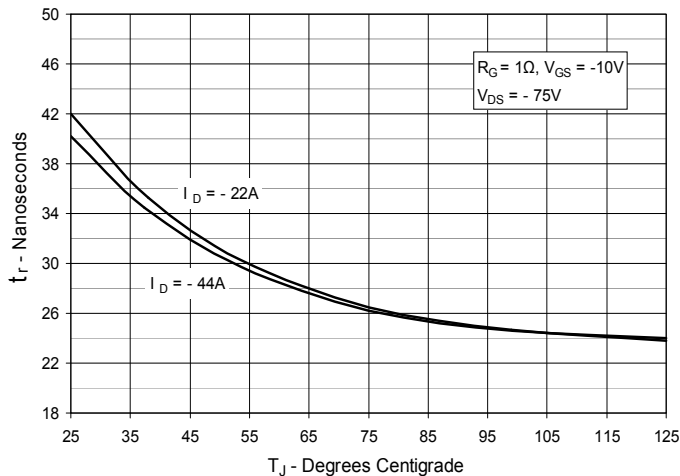

Fig. 14. Resistive Turn-on Rise Time vs. Drain Current

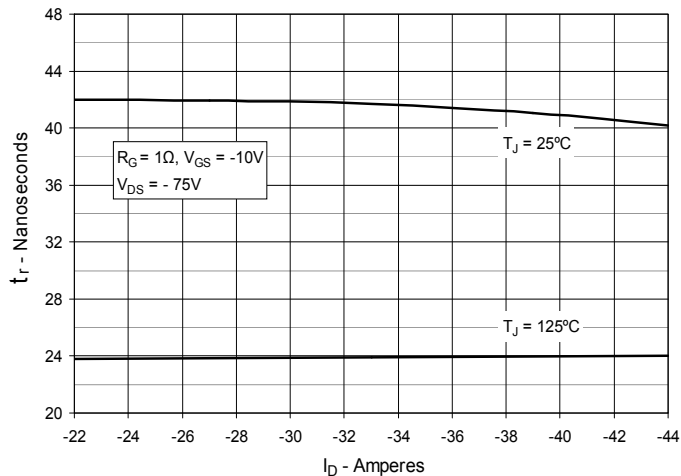

Fig. 15. Resistive Turn-on Switching Times vs. Gate Resistance

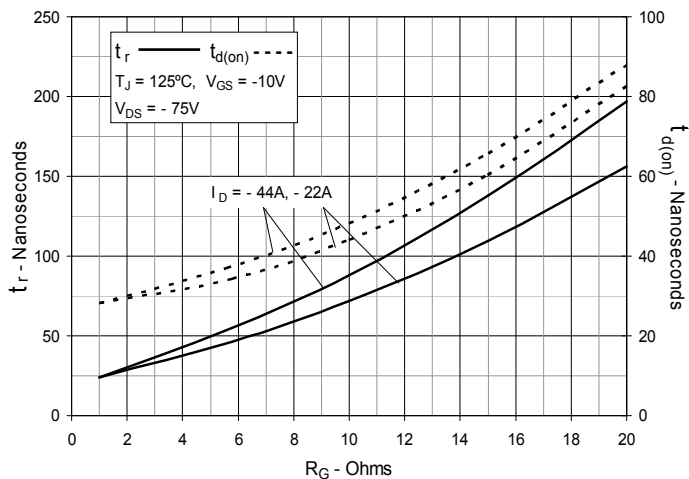

Fig. 16. Resistive Turn-off Switching Times vs. Junction Temperature

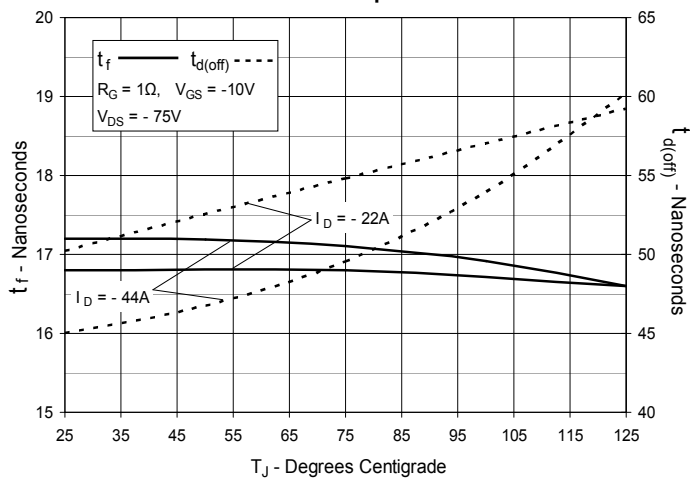

Fig. 17. Resistive Turn-off Switching Times vs. Drain Current

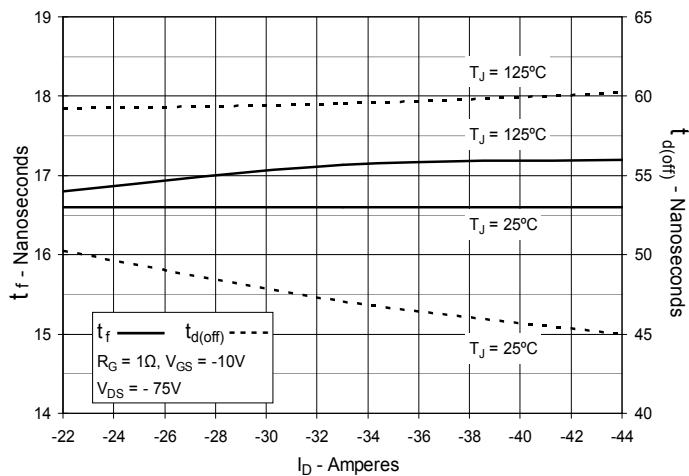

Fig. 18. Resistive Turn-off Switching Times vs. Gate Resistance

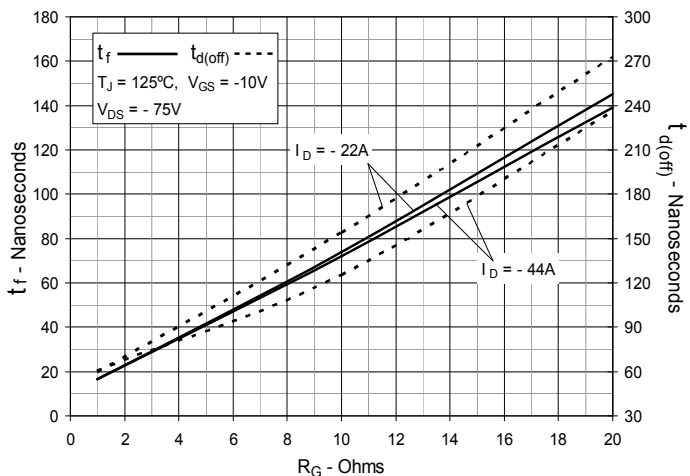
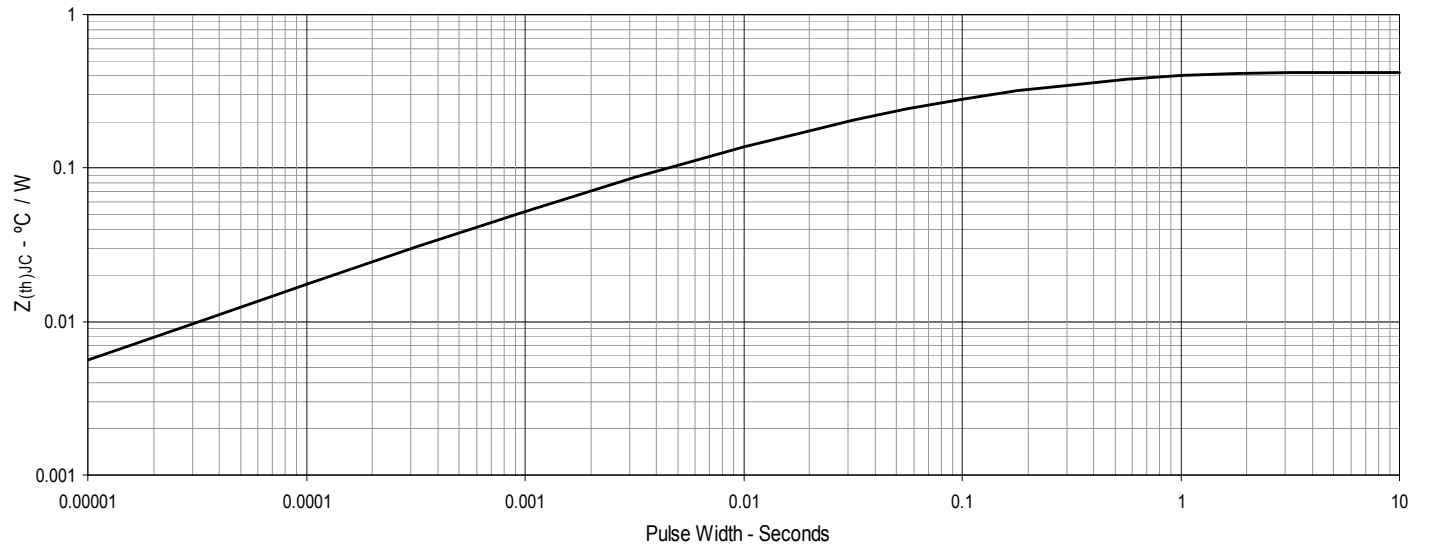

Fig. 19. Maximum Transient Thermal Impedance





Disclaimer Notice - Information furnished is believed to be accurate and reliable. However, users should independently evaluate the suitability of and test each product selected for their own applications. Littelfuse products are not designed for, and may not be used in, all applications. Read complete Disclaimer Notice at www.littelfuse.com/disclaimer-electronics.