

# CoolMOS™ 1) Power MOSFET

## ISOPLUS™ - electrically isolated surface to heatsink

### Surface Mount Power Device

$$V_{DSS} = 600 \text{ V}$$

$$I_{D25} = 50 \text{ A}$$

$$R_{DS(on) \text{ max}} = 45 \text{ m}\Omega$$

Preliminary data

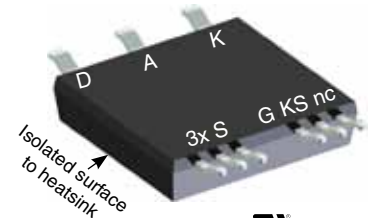
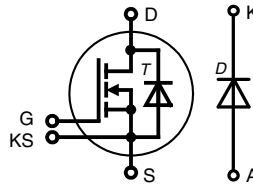

E72873

MOSFET T		Maximum Ratings	
Symbol	Conditions		
$V_{DSS}$	$T_{VJ} = 25^\circ\text{C to } 150^\circ\text{C}$	600	V
$V_{GS}$		$\pm 20$	V
$I_{D25}$	$T_C = 25^\circ\text{C}$	50	A
$I_{D80}$	$T_C = 80^\circ\text{C}$	38	A
$E_{AS}$	single pulse } $I_D = 11 \text{ A}; T_C = 25^\circ\text{C}$ repetitive	1950	mJ
$E_{AR}$		3	mJ
$dV/dt$	MOSFET $dV/dt$ ruggedness $V_{DS} = 0 \dots 480 \text{ V}$	50	V/ns

Symbol	Conditions	Characteristic Values				
		min.	typ.	max.		
$(T_{VJ} = 25^\circ\text{C}, \text{ unless otherwise specified})$						
$R_{DS(on)}$	$I_D = 44 \text{ A}; V_{GS} = 10 \text{ V}$		40	45	m $\Omega$	
$V_{GS(th)}$	$I_D = 3 \text{ mA}; V_{DS} = V_{GS}$	2.5	3	3.5	V	
$I_{DSS}$	$V_{DS} = V_{DSS}; V_{GS} = 0 \text{ V}; T_{VJ} = 25^\circ\text{C}$ $T_{VJ} = 125^\circ\text{C}$		50	10	$\mu\text{A}$ $\mu\text{A}$	
$I_{GSS}$	$V_{DS} = 0 \text{ V}; V_{GS} = \pm 20 \text{ V}$			100	nA	
$t_{d(on)}$	Inductive switching boost mode with diode D $V_{DS} = 380 \text{ V}; I_D = 30 \text{ A}$ $V_{GS} = 10 \text{ V}; R_G = 33 \Omega$		80		ns	
$t_r$			40		ns	
$t_{d(off)}$			750		ns	
$t_f$			40		ns	
$E_{on}$				1.3		mJ
$E_{off}$				0.45		mJ
$E_{rec}$				0.35		mJ
$C_{iss}$	$V_{GS} = 0 \text{ V}; V_{DS} = 100 \text{ V}; f = 1 \text{ MHz}$		6800		pF	
$C_{oss}$				320		pF
$Q_g$	$V_{DS} = 400 \text{ V}; I_D = 44 \text{ A}$ $V_{GS} = 10 \text{ V}; R_G = 3.3 \Omega$		150	190	nC	
$Q_{gs}$			35		nC	
$Q_{gd}$			50		nC	
$R_{thJC}$	with heatsink compound (IXYS test setup)			0.4	K/W	
$R_{thJH}$			tbd	tbd	K/W	

### Features

- **Fast CoolMOS™ 1)** power MOSFET 4<sup>th</sup> generation
  - high blocking capability
  - lowest resistance
  - avalanche rated for unclamped inductive switching (UIS)
  - low thermal resistance due to reduced chip thickness
- **Package**
  - isolated surface to heatsink
  - low coupling capacity between pins and heatsink
  - PCB space saving
  - enlarged creepage towards heatsink
  - application friendly pinout
  - low inductive current path
  - high reliability

### Applications

- Buck / boost chopper
- Optimized for boost configuration
- PFC stage

<sup>1)</sup> CoolMOS™ is a trademark of Infineon Technologies AG.

Source-Drain Diode of MOSFET T					
Symbol	Conditions	Maximum Ratings			
$I_{S25}$	$T_C = 25^\circ\text{C}$	50	A		
$I_{S80}$	$T_C = 80^\circ\text{C}$	38	A		
Symbol	Conditions	Characteristic Values			
( $T_{VJ} = 25^\circ\text{C}$ , unless otherwise specified)					
$V_{SD}$	$I_F = 44\text{ A}; V_{GS} = 0\text{ V}$	min.	typ.	max.	V
$t_{rr}$	$I_F = 44\text{ A}; -di_F/dt = 100\text{ A}/\mu\text{s}; V_R = 400\text{ V}$		600		ns
$Q_{RM}$			17		$\mu\text{C}$
$I_{RM}$			60		A

Diode D					
Symbol	Conditions	Maximum Ratings			
$I_{F25}$	$T_C = 25^\circ\text{C}; \text{DC}$	96	A		
$I_{F80}$	$T_C = 80^\circ\text{C}; \text{DC}$	61	A		
Symbol	Conditions	Characteristic Values			
( $T_{VJ} = 25^\circ\text{C}$ , unless otherwise specified)					
$V_{RRM}$	$T_{VJ} = 25^\circ\text{C}$	min.	typ.	max.	V
$V_F$	$I_F = 25\text{ A}$		1.2	1.4	V
			1.3		
$I_R$	$V_R = V_{RRM}$			150	$\mu\text{A}$
			tbd		mA
$I_{RM}$	$I_F = 30\text{ A}; V_R = 350\text{ V}$ $-di/dt = 240\text{ A}/\mu\text{s}$		10		A
$t_{rr}$	$I_F = 1\text{ A}; V_R = 30\text{ V}$ $-di/dt = 100\text{ A}/\mu\text{s}$		35	50	ns
$R_{thJC}$	per diode			0.7	K/W
$R_{thJH}$	with heatsink compound (IXYS test setup)		tbd		k/W

Component					
Symbol	Conditions	Maximum Ratings			
$T_{VJ}$		-55...+150 °C			
$T_{stg}$		-55...+125 °C			
$V_{ISOL}$	$I_{ISOL} \leq 1\text{ mA}; 50/60\text{ Hz}$	2500 V~			
$F_C$	mounting force	40 ... 130 N			
Symbol	Conditions	Characteristic Values			
$C_P$	coupling capacity between shorted pins and backside metal	min.	typ.	max.	pF
$d_S, d_A$	pin - pin	1.65			mm
$d_S, d_A$	pin - backside metal	4			mm
CTI		400			
Weight			8		g

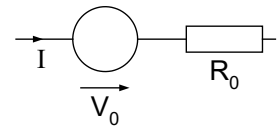
**Equivalent Circuits for Simulation**
**Conduction**

Boost Diode (typ. at  $T_J = 125^\circ\text{C}$ )  
 $V_0 = \text{tbd V}; R_0 = \text{tbd m}\Omega$

Ordering	Part Number	Marking on Product	Delivering Mode	Base Qty	Ordering Code
Standard	MKE38RK600DFELB-TRR	MKE38RK600DFELB	Tape & Reel	200	510479
	MKE38RK600DFELB	MKE38RK600DFELB	Blister	45	510231

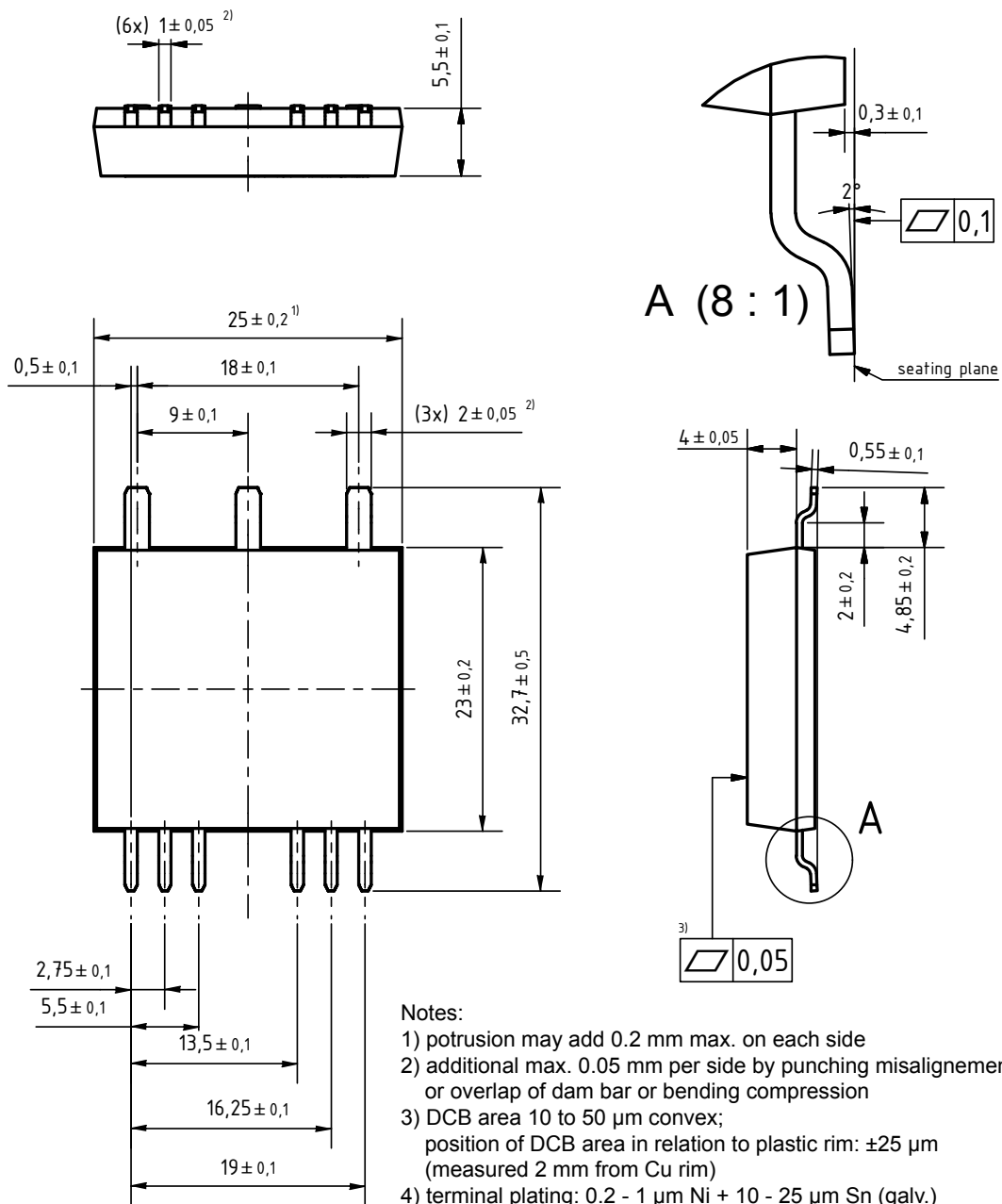

- Notes:
- 1) protrusion may add 0.2 mm max. on each side
  - 2) additional max. 0.05 mm per side by punching misalignment or overlap of dam bar or bending compression
  - 3) DCB area 10 to 50  $\mu$ m convex; position of DCB area in relation to plastic rim:  $\pm 25 \mu$ m (measured 2 mm from Cu rim)
  - 4) terminal plating: 0.2 - 1  $\mu$ m Ni + 10 - 25  $\mu$ m Sn (galv.) cutting edges may be partially free of plating

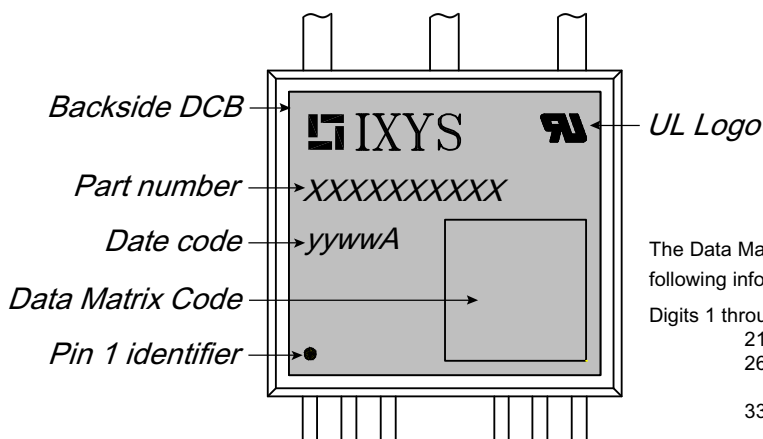

The Data Matrix Code contains the following information in 36 digits:

- Digits 1 through 20: part number
- 21 to 25: date code (YYWWA)
- 26 to 31: assembly lot code
- 32: reserved for special information
- 33 to 36: may be used for subsequent module numbering within the assembly lot

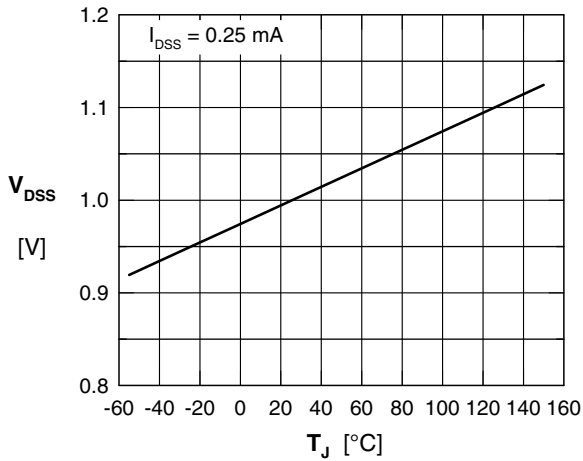

Fig. 1 Drain source breakdown voltage versus temperature  $T_{VJ}$

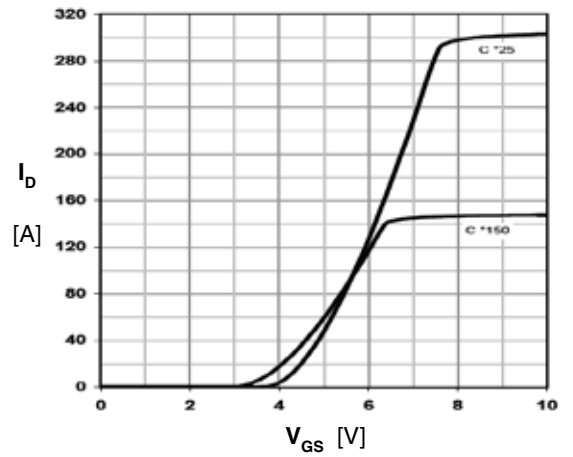

Fig. 2 Typ. transfer characteristics

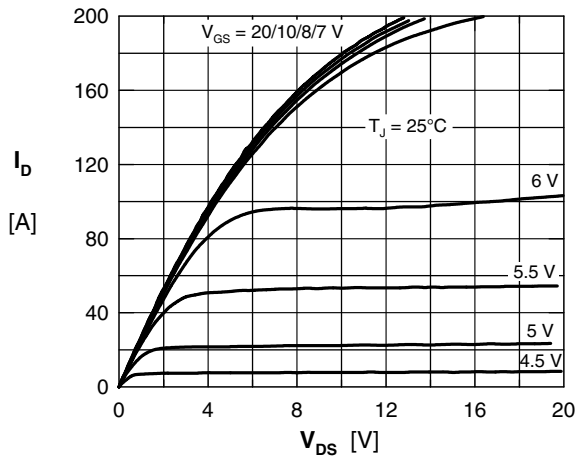

Fig. 3 Typical output characteristics

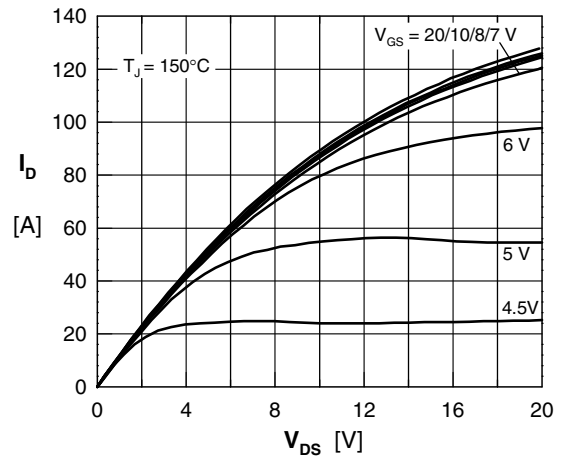

Fig. 4 Typical output characteristics

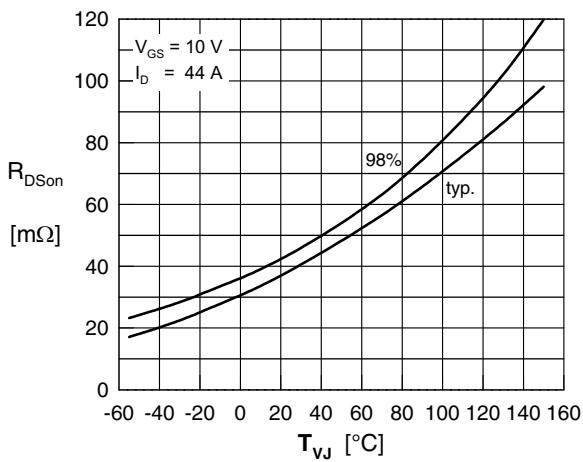

Fig. 5 Drain source on-state resistance  $R_{DS(on)}$  vs. junction temperature  $T_{VJ}$

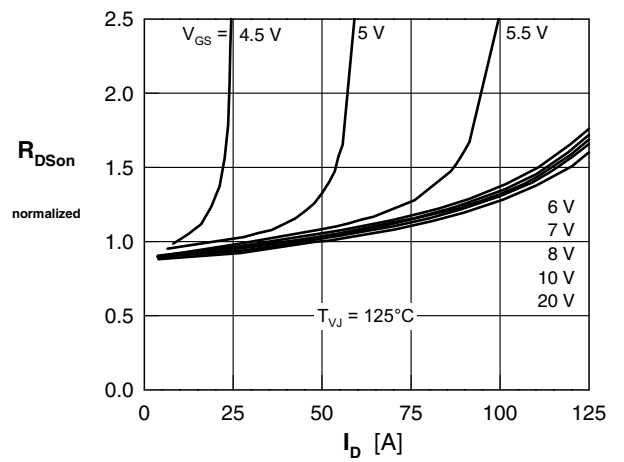

Fig. 6 Drain source on-state resistance,  $R_{DS(on)}$  versus  $I_D$

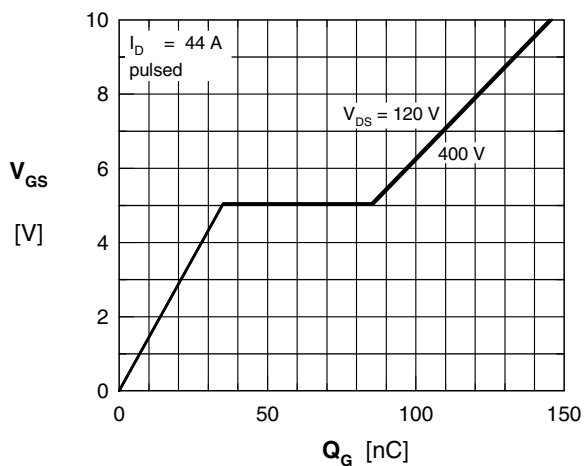

Fig. 7 Typ. turn-on gate charge

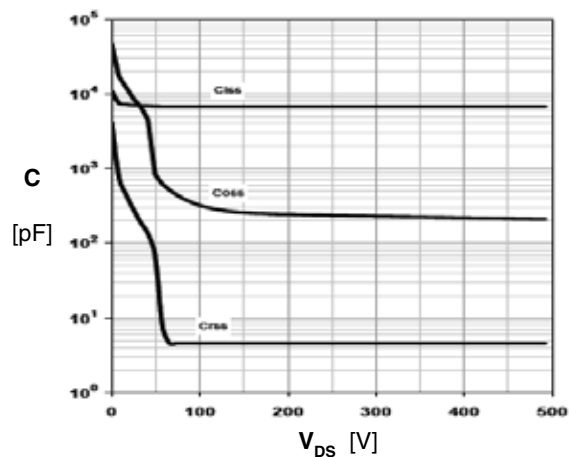

Fig. 8 Typ. capacities, MOSFET only

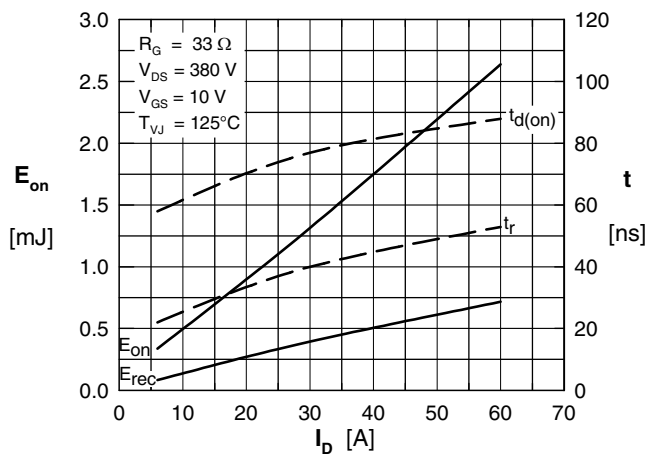

Fig. 9 Typ. turn-on energy and switching times vs. collector current, inductive switching

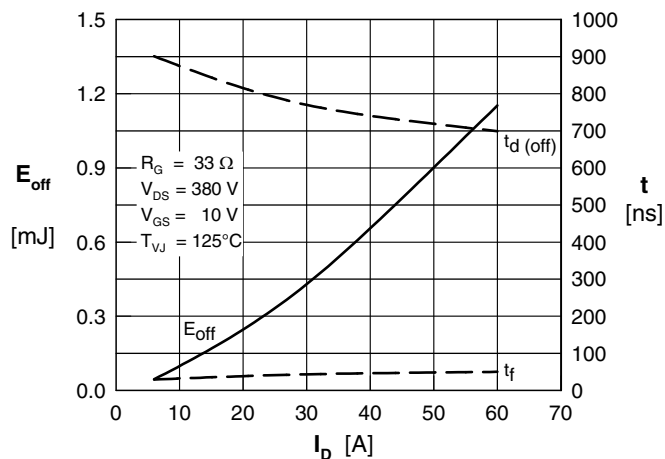

Fig. 10 Typ. turn-off energy and switching times vs. collector-current, inductive switching

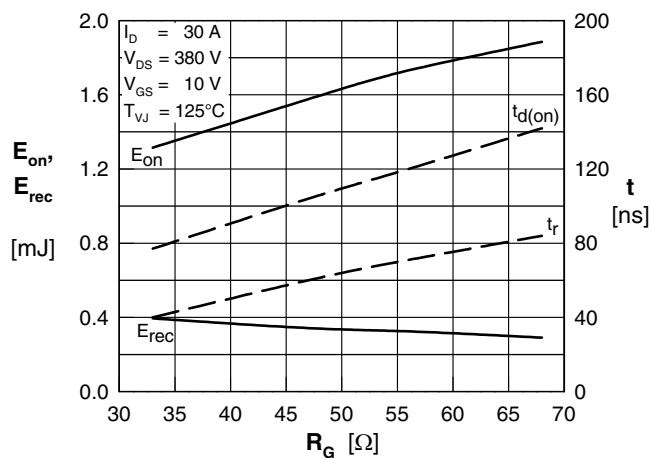

Fig. 11 Typ. turn-on energy and switching times vs. gate resistor, inductive switching

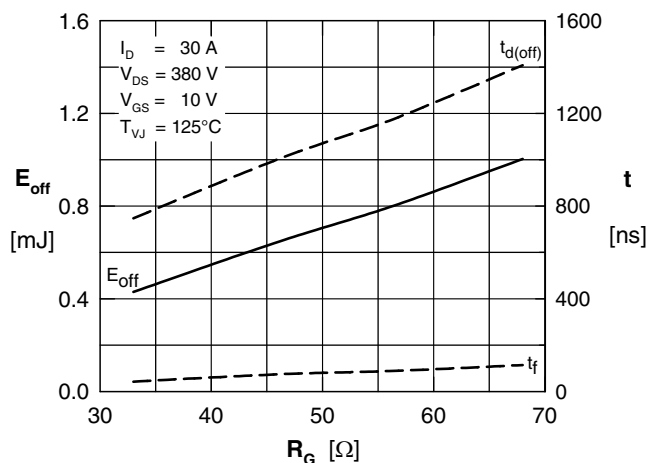

Fig. 12 Typ. turn-off energy and switching times vs. gate resistor, inductive switching

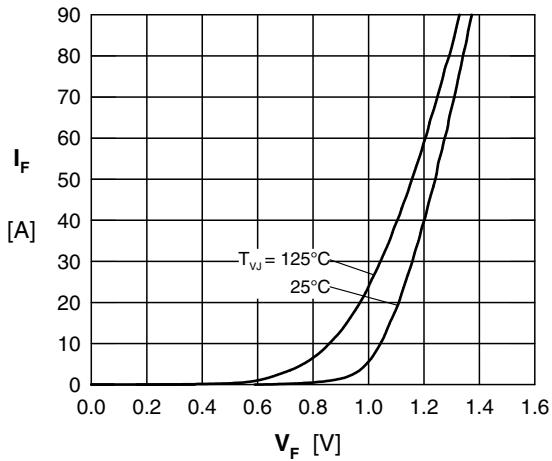

Fig. 13 Typ. forward characteristics of diode D

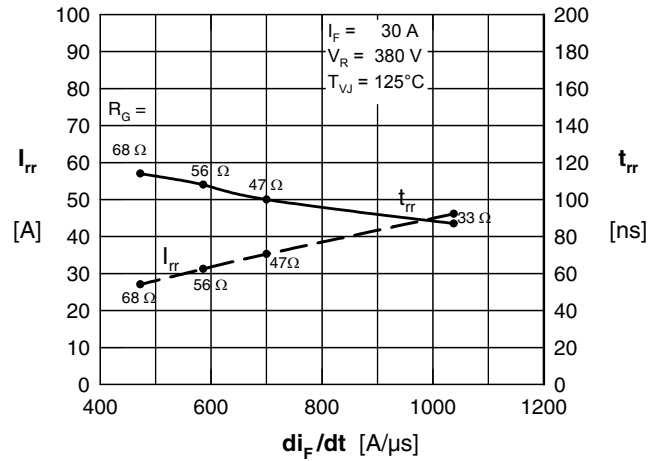

Fig. 14 Typ. reverse recovery characteristics of diode D

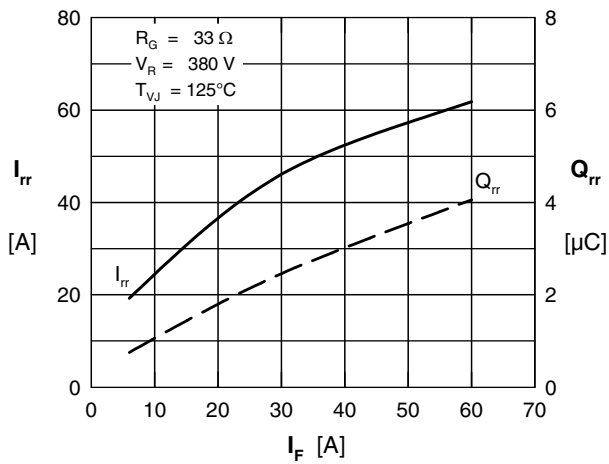

Fig. 15 Typ. reverse recovery characteristics of diode D



---

Disclaimer Notice - Information furnished is believed to be accurate and reliable. However, users should independently evaluate the suitability of and test each product selected for their own applications. Littelfuse products are not designed for, and may not be used in, all applications. Read complete Disclaimer Notice at [www.littelfuse.com/disclaimer-electronics](http://www.littelfuse.com/disclaimer-electronics).